

RF Toolbox™

User's Guide



MATLAB®

R2015b

 MathWorks®

How to Contact MathWorks



Latest news: www.mathworks.com
Sales and services: www.mathworks.com/sales_and_services
User community: www.mathworks.com/matlabcentral
Technical support: www.mathworks.com/support/contact_us



Phone: 508-647-7000



The MathWorks, Inc.
3 Apple Hill Drive
Natick, MA 01760-2098

RF Toolbox™ User's Guide

© COPYRIGHT 2004–2015 by The MathWorks, Inc.

The software described in this document is furnished under a license agreement. The software may be used or copied only under the terms of the license agreement. No part of this manual may be photocopied or reproduced in any form without prior written consent from The MathWorks, Inc.

FEDERAL ACQUISITION: This provision applies to all acquisitions of the Program and Documentation by, for, or through the federal government of the United States. By accepting delivery of the Program or Documentation, the government hereby agrees that this software or documentation qualifies as commercial computer software or commercial computer software documentation as such terms are used or defined in FAR 12.212, DFARS Part 227.72, and DFARS 252.227-7014. Accordingly, the terms and conditions of this Agreement and only those rights specified in this Agreement, shall pertain to and govern the use, modification, reproduction, release, performance, display, and disclosure of the Program and Documentation by the federal government (or other entity acquiring for or through the federal government) and shall supersede any conflicting contractual terms or conditions. If this License fails to meet the government's needs or is inconsistent in any respect with federal procurement law, the government agrees to return the Program and Documentation, unused, to The MathWorks, Inc.

Trademarks

MATLAB and Simulink are registered trademarks of The MathWorks, Inc. See www.mathworks.com/trademarks for a list of additional trademarks. Other product or brand names may be trademarks or registered trademarks of their respective holders.

Patents

MathWorks products are protected by one or more U.S. patents. Please see www.mathworks.com/patents for more information.

Revision History

June 2004	Online only	New for Version 1.0 (Release 14)
August 2004	Online only	Revised for Version 1.0.1 (Release 14+)
March 2005	Online only	Revised for Version 1.1 (Release 14SP2)
September 2005	Online only	Revised for Version 1.2 (Release 14SP3)
March 2006	Online only	Revised for Version 1.3 (Release 2006a)
September 2006	Online only	Revised for Version 2.0 (Release 2006b)
March 2007	Online only	Revised for Version 2.1 (Release 2007a)
September 2007	Online only	Revised for Version 2.2 (Release 2007b)
March 2008	Online only	Revised for Version 2.3 (Release 2008a)
October 2008	Online only	Revised for Version 2.4 (Release 2008b)
March 2009	Online only	Revised for Version 2.5 (Release 2009a)
September 2009	Online only	Revised for Version 2.6 (Release 2009b)
March 2010	Online only	Revised for Version 2.7 (Release 2010a)
September 2010	Online only	Revised for Version 2.8 (Release 2010b)
April 2011	Online only	Revised for Version 2.8.1 (Release 2011a)
September 2011	Online only	Revised for Version 2.9 (Release 2011b)
March 2012	Online only	Revised for Version 2.10 (Release 2012a)
September 2012	Online only	Revised for Version 2.11 (Release 2012b)
March 2013	Online only	Revised for Version 2.12 (Release 2013a)
September 2013	Online only	Revised for Version 2.13 (Release 2013b)
March 2014	Online only	Revised for Version 2.14 (Release 2014a)
October 2014	Online only	Revised for Version 2.15 (Release 2014b)
March 2015	Online only	Revised for Version 2.16 (Release 2015a)
September 2015	Online only	Revised for Version 2.17 (Release 2015b)

RF Toolbox Product Description	1-2
Key Features	1-2
Related Products	1-3
RF Objects	1-4
S-Parameter Notation	1-6
Define S-Parameters	1-6
Refer to S-Parameters Using Strings	1-7
RF Analysis	1-8
Model a Cascaded RF Network	1-10
Overview	1-10
Create RF Components	1-10
Specify Component Data	1-11
Validate RF Components	1-11
Build and Simulate the Network	1-14
Analyze Simulation Results	1-14
Analyze a Transmission Line	1-18
Overview	1-18
Build and Simulate the Transmission Line	1-18
Compute the Transmission Line Transfer Function and Time-Domain Response	1-18
Export a Verilog-A Model	1-23

2

RF Data Objects	2-2
Overview	2-2
Types of Data	2-2
Available Data Objects	2-2
Data Object Methods	2-3
RF Circuit Objects	2-4
Overview of RF Circuit Objects	2-4
Components Versus Networks	2-4
Available Components and Networks	2-5
Circuit Object Methods	2-6
RF Model Objects	2-9
Overview of RF Model Objects	2-9
Available Model Objects	2-9
Model Object Methods	2-9
RF Network Parameter Objects	2-11
Overview of Network Parameter Objects	2-11
Available Network Parameter Objects	2-11
Network Parameter Object Functions	2-11

Model an RF Component

3

Create RF Objects	3-2
Construct a New Object	3-2
Copy an Existing Object	3-3
Specify or Import Component Data	3-5
RF Object Properties	3-5
Set Property Values	3-5
Import Property Values from Data Files	3-8
Use Data Objects to Specify Circuit Properties	3-10
Retrieve Property Values	3-13
Reference Properties Directly Using Dot Notation	3-14

Specify Operating Conditions	3-16
Available Operating Conditions	3-16
Set Operating Conditions	3-16
Display Available Operating Condition Values	3-17
Process File Data for Analysis	3-18
Convert Single-Ended S-Parameters to Mixed-Mode S-Parameters	3-18
Extract M-Port S-Parameters from N-Port S-Parameters ..	3-19
Cascade N-Port S-Parameters	3-21
Analyze and Plot RF Components	3-23
Analyze Networks in the Frequency Domain	3-23
Visualize Component and Network Data	3-23
Compute and Plot Time-Domain Specifications	3-32
Export Component Data to a File	3-35
Available Export Formats	3-35
How to Export Object Data	3-35
Export Object Data	3-36
Basic Operations with RF Objects	3-38
Read and Analyze RF Data from a Touchstone Data File ...	3-38
De-Embed S-Parameters	3-40

Export Verilog-A Models

4

Model RF Objects Using Verilog-A	4-2
Overview	4-2
Behavioral Modeling Using Verilog-A	4-2
Supported Verilog-A Models	4-3
Export a Verilog-A Model	4-4
Represent a Circuit Object with a Model Object	4-4
Write a Verilog-A Module	4-5

The RF Design and Analysis App	5-2
What Is the RF Design and Analysis App?	5-2
Open the RF Design and Analysis App	5-2
The RF Design and Analysis Window	5-3
The RF Design and Analysis App Workflow	5-4
Create and Import Circuits	5-6
Circuits in the RF Design and Analysis App	5-6
Create RF Components	5-6
Create RF Networks	5-10
Import RF Objects into the RF Design and Analysis App ...	5-16
Modify Component Data	5-20
Analyze Circuits	5-21
Export RF Objects	5-24
Export Components and Networks	5-24
Export to the Workspace	5-24
Export to a File	5-26
Manage Circuits and Sessions	5-29
Working with Circuits	5-29
Working with the RF Design and Analysis App Sessions ...	5-30
Model an RF Network	5-33
Overview	5-33
Start the RF Design and Analysis App	5-33
Create the Amplifier Network	5-33
Populate the Amplifier Network	5-36
Analyze the Amplifier Network	5-39
Export the Network to the Workspace	5-41

Objects — Alphabetical List

6

Methods — Alphabetical List

7

Functions — Alphabetical List

8

AMP File Format

9

AMP File Data Sections	9-2
Overview	9-2
Denoting Comments	9-3
Data Sections	9-3
S, Y, or Z Network Parameters	9-3
Noise Parameters	9-5
Noise Figure Data	9-6
Power Data	9-8
IP3 Data	9-10
Inconsistent Data Sections	9-11

Getting Started

- “RF Toolbox Product Description” on page 1-2
- “Related Products” on page 1-3
- “RF Objects” on page 1-4
- “S-Parameter Notation” on page 1-6
- “RF Analysis” on page 1-8
- “Model a Cascaded RF Network” on page 1-10
- “Analyze a Transmission Line” on page 1-18

RF Toolbox Product Description

Design, model, and analyze networks of RF components

RF Toolbox provides functions and an app for designing, modeling, analyzing, and visualizing networks of radio frequency (RF) components. You can use RF Toolbox software for working on wireless communications, radar, and signal integrity projects.

Key Features

- Provides read and write access to industry-standard file formats for network parameters
- Defines RF filters, transmission lines, amplifiers, and mixers by their experimental or theoretical network parameters and physical properties
- Calculates network parameters for RF components in series, parallel, cascade, hybrid, and inverse hybrid configurations
- Builds models using the rational function fitting method
- Exports rational function models to Simulink® or as Verilog-A modules
- Calculates noise figures and third-order intercept points for cascaded components
- Converts among S, Y, Z, ABCD, h, g, and T network parameters
- Includes rectangular and polar plots and Smith® Charts for visualizing data

Related Products

Several MathWorks® products are especially relevant to the kinds of tasks you can perform with RF Toolbox software. The following table summarizes the related products and describes how they complement the features of the toolbox.

Product	Description
“Communications System Toolbox”	Simulink blocks and MATLAB® functions for time-domain simulation of modulation and demodulation of a wireless communications signal.
“DSP System Toolbox”	Simulink blocks and MATLAB functions for time-domain simulation of for filtering the modulated communication signal.
“SimRF”	Circuit-envelope and equivalent-baseband simulation of RF components in Simulink.
“Signal Processing Toolbox”	MATLAB functions for filtering the modulated communication signal.

RF Objects

RF Toolbox software uses objects to represent RF components and networks. You create an object using the object's *constructor*. Every object has predefined fields called *properties*. The properties define the characteristics of the object. Each property associated with an object is assigned a value. Every object has a set of *methods*, which are operations that you can perform on the object. Methods are similar to functions except that they only act on an object.

The following table summarizes the types of objects that are available in the toolbox and describes the uses of each one. For more information on a particular type of object, including a list of the available objects and methods, follow the link in the table to the documentation for that object type.

Object Type	Name	Description
“RF Data Objects” on page 2-2	<code>rfdata</code>	Stores data for use by other RF objects or for plotting and network parameter conversion.
“RF Circuit Objects” on page 2-4	<code>rfckt</code>	Represents RF components and networks using network parameters and physical properties for frequency-domain simulation.
“RF Model Objects” on page 2-9	<code>rfmodel</code>	Represents RF components and networks mathematically for computing time-domain behavior and exporting models.

Each name in the preceding table is the prefix to the names of all object constructors of that type. The constructors use *dot notation* that consists of the object type, followed by a dot and then the component name. The component name is also called the *class*. For information on how to construct an RF object from the command line using dot notation, see “Create RF Objects” on page 3-2.

You use a different form of dot notation to specify object properties, as described in “Reference Properties Directly Using Dot Notation” on page 3-14. This is just one way to define component data. For more information on object properties, see “Specify or Import Component Data” on page 3-5.

You use object methods to perform frequency-domain analysis and visualize the results. For more information, see “Analyze and Plot RF Components” on page 3-23.

Note: The toolbox also provides a graphical interface for creating and analyzing circuit objects. For more information, see “The RF Design and Analysis App” on page 5-2.

S-Parameter Notation

In this section...

“Define S-Parameters” on page 1-6

“Refer to S-Parameters Using Strings” on page 1-7

Define S-Parameters

RF Toolbox software uses matrix notation to specify S-parameters. The indices of an S-parameter matrix correspond to the port numbers of the network that the data represent. For example, to define a matrix of 50-ohm, 2-port S-parameters, type:

```
s11 = 0.61*exp(j*165/180*pi);
s21 = 3.72*exp(j*59/180*pi);
s12 = 0.05*exp(j*42/180*pi);
s22 = 0.45*exp(j*(-48/180)*pi);
s_params = [s11 s12; s21 s22];
```

RF Toolbox functions that operate on `s_params` assume:

- `s_params(1,1)` corresponds to the reflection coefficient at port 1, S_{11} .
- `s_params(2,1)` corresponds to the transmission coefficient from port 1 to port 2, S_{21} .
- `s_params(1,2)` corresponds to the transmission coefficient from port 2 to port 1, S_{12} .
- `s_params(2,2)` corresponds to the reflection coefficient at port 2, S_{22} .

RF Toolbox software also supports three-dimensional arrays of S-parameters. The third dimension of an S-parameter array corresponds to S-parameter data at different frequencies. The following figure illustrates this convention.

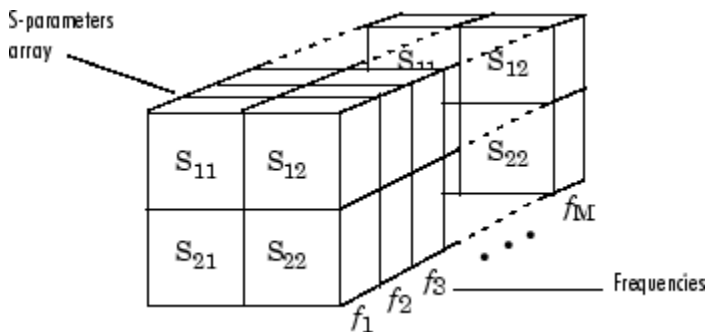

Refer to S-Parameters Using Strings

RF Toolbox software uses strings to refer to S-parameters in plotting and calculation methods, such as `plot`. These strings have one of the following two forms:

- `'Snm'` — Use this syntax if n and m are both less than 10.
- `'Sn,m'` — Use this syntax if one or both are greater than 10. `'Sn,m'` is not a valid syntax when both n and m are less than 10.

The indices n and m are the port numbers for the S-parameters.

Most toolbox objects only analyze 2-port S-parameters. The following objects analyze S-parameters with more than two ports:

- `rfckt.passive`
- `rfckt.datafile`
- `rfddata.data`

You can get 2-port parameters from S-parameters with an arbitrary number of ports using one or more of the following steps:

- Extract 2-port S-parameters from N-port S-parameters.

See “Extract M-Port S-Parameters from N-Port S-Parameters” on page 3-19.

- Convert single-ended 4-port parameters to differential 2-port parameters.

See “Convert Single-Ended S-Parameters to Mixed-Mode S-Parameters” on page 3-18.

RF Analysis

When you analyze an RF circuit using RF Toolbox software, your workflow might include the following tasks:

- 1** Select RF circuit objects to represent the components of your RF network.

See “Create RF Objects” on page 3-2.
- 2** Define component data by:
 - Specifying network parameters or physical properties (see “Set Property Values” on page 3-5).
 - Importing data from an industry-standard Touchstone file, a MathWorks AMP file, an Agilent® P2D or S2D file, or the MATLAB workspace (see “Import Property Values from Data Files” on page 3-8).
 - Where applicable, selecting operating condition values (see “Specify Operating Conditions” on page 3-16).
- 3** Where applicable, perform network parameter conversions on imported file data.

See “Process File Data for Analysis” on page 3-18.
- 4** Integrate components to form a cascade, hybrid, parallel, or series network.

See “Construct Networks of Specified Components” on page 3-7.
- 5** Analyze the network in the frequency domain.

See “Analyze Networks in the Frequency Domain” on page 3-23.
- 6** Generate plots to gain insight into network behavior.

The following plots and charts are available in the toolbox:

- Rectangular plots
- Polar plots
- Smith Charts
- Budget plots (for cascaded S-parameters)

See “Visualize Component and Network Data” on page 3-23.

- 7** Compute the network transfer function.

- See “Compute the Network Transfer Function” on page 3-32.
- 8** Create an RF model object that describes the transfer function analytically.
- See “Fit a Model Object to Circuit Object Data” on page 3-32.
- 9** Plot the time-domain response.
- See “Compute and Plotting the Time-Domain Response” on page 3-33.
- 10** Export a Verilog-A description of the network.
- See “Export a Verilog-A Model” on page 4-4.

Model a Cascaded RF Network

In this section...
“Overview” on page 1-10
“Create RF Components” on page 1-10
“Specify Component Data” on page 1-11
“Validate RF Components” on page 1-11
“Build and Simulate the Network” on page 1-14
“Analyze Simulation Results” on page 1-14

Overview

In this example, you use the RF Toolbox command-line interface to model the gain and noise figure of a cascaded network. You analyze the network in the frequency domain and plot the results.

Note: To learn how to use RF Design and Analysis App, to perform these tasks, see “Model an RF Network” on page 5-33.

The network that you use in this example consists of an amplifier and two transmission lines. The toolbox represents RF components and RF networks using RF circuit objects. You learn how to create and manipulate these objects to analyze the cascaded amplifier network.

Create RF Components

Type the following set of commands at the MATLAB prompt to create three circuit (rfckt) objects with the default property values. These circuit objects represent the two transmission lines and the amplifier:

```
FirstCkt = rfckt.txline;  
SecondCkt = rfckt.amplifier;  
ThirdCkt = rfckt.txline;
```

Specify Component Data

In this part of the example, you specify the following component properties:

- “Transmission Line Properties” on page 1-11
- “Amplifier Properties” on page 1-11

Transmission Line Properties

- 1 Type the following command at the MATLAB prompt to change the line length of the first transmission line, `FirstCkt`, to 12:

```
FirstCkt.LineLength = 12;
```

- 2 Type the following command at the MATLAB prompt to change the line length of the second transmission line, `ThirdCkt`, to 0.025 and to change the phase velocity to 2.0e8:

```
ThirdCkt.LineLength = 0.025;  
ThirdCkt.PV = 2.0e8;
```

Amplifier Properties

- 1 Type the following command at the MATLAB prompt to import network parameters, noise data, and power data from the `default.amp` file into the amplifier, `SecondCkt`:

```
read(SecondCkt, 'default.amp');
```

- 2 Type the following command at the MATLAB prompt to change the interpolation method of the amplifier, `SecondCkt`, to `cubic`:

```
SecondCkt.IntpType = 'cubic';
```

The `IntpType` property tells the toolbox how to interpolate the network parameters, noise data, and power data when you analyze the amplifier at frequencies other than those specified in the file.

Validate RF Components

In this part of the example, you plot the network parameters and power data (output power versus input power) to validate the behavior of the amplifier.

- 1 Type the following set of commands at the MATLAB prompt to use the `smith` command to plot the original S_{11} and S_{22} parameters of the amplifier (SecondCkt) on a Z Smith Chart:

```
figure  
lineseries1 = smith(SecondCkt, 'S11', 'S22');  
lineseries1(1).LineStyle = '-';  
lineseries1(1).LineWidth = 1;  
lineseries1(2).LineStyle = ':';  
lineseries1(2).LineWidth = 1;  
legend show
```

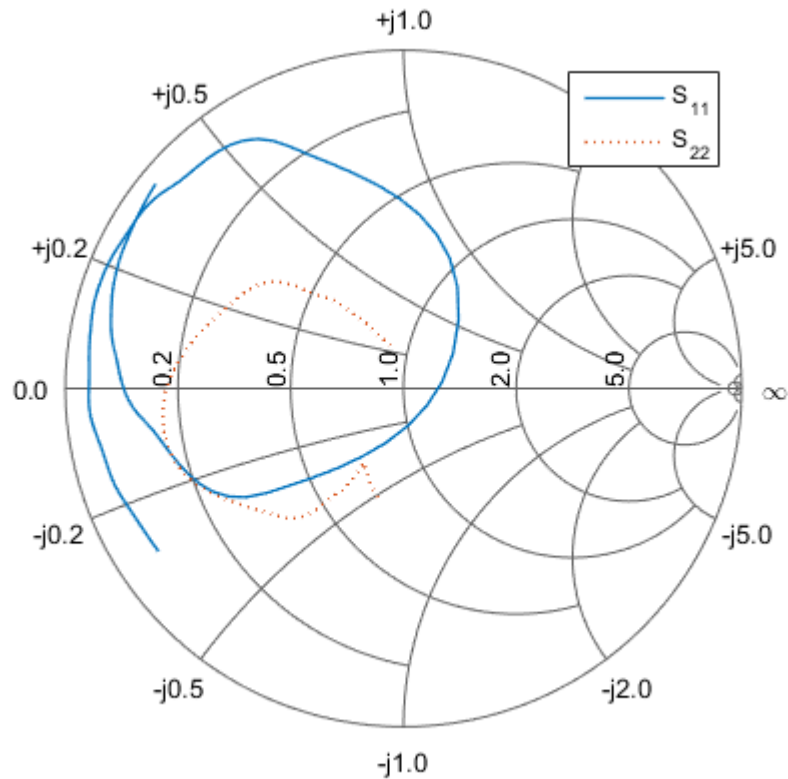

Note: The plot shows the S-parameters over the frequency range for which network data is specified in the `default.amp` file — from 1 GHz to 2.9 GHz.

- 2 Type the following set of commands at the MATLAB prompt to use the RF Toolbox `plot` command to plot the amplifier (`SecondCkt`) output power (P_{out}) as a function of input power (P_{in}), both in decibels referenced to one milliwatt (dBm), on an X-Y plane plot:

```
figure
plot(SecondCkt, 'Pout', 'dBm')
legend show
```

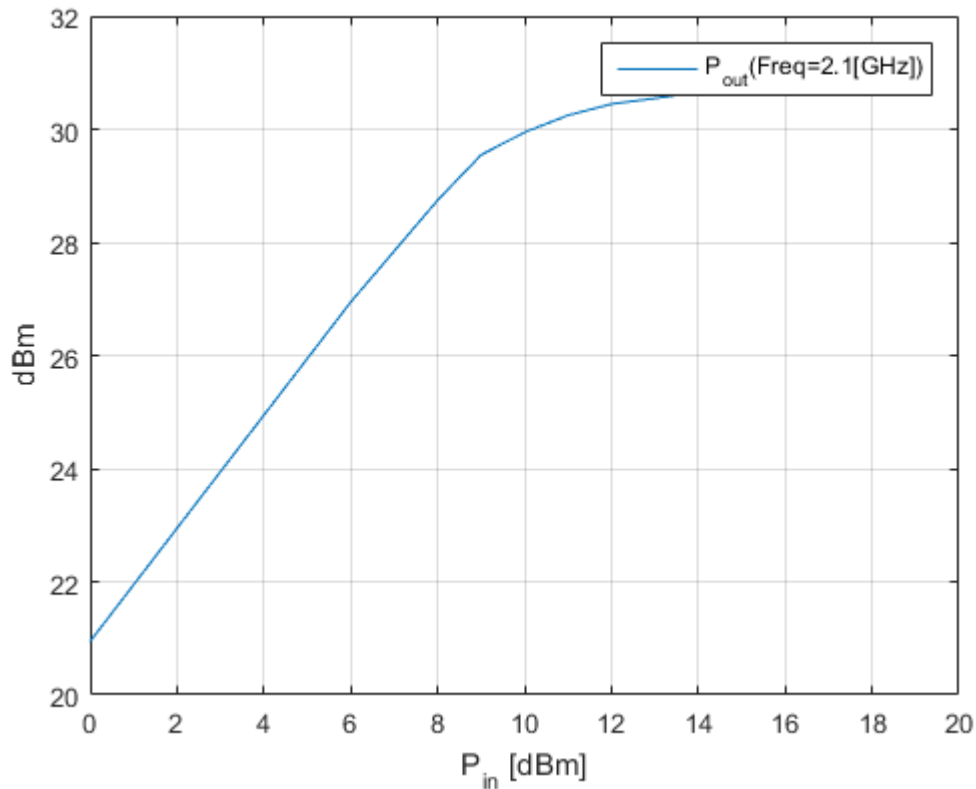

Note: The plot shows the power data at 2.1 GHz because this frequency is the one for which power data is specified in the `default.amp` file.

Build and Simulate the Network

In this part of the example, you create a circuit object to represent the cascaded amplifier and analyze the object in the frequency domain.

- 1 Type the following command at the MATLAB prompt to cascade the three circuit objects to form a new cascaded circuit object, `CascadedCkt`:

```
FirstCkt = rfckt.txline;
SecondCkt = rfckt.amplifier;
ThirdCkt = rfckt.txline;

CascadedCkt = rfckt.cascade('Ckts', {FirstCkt, SecondCkt, ...
    ThirdCkt});
```

- 2 Type the following set of commands at the MATLAB prompt to define the range of frequencies over which to analyze the cascaded circuit, and then run the analysis:

```
f = (1.0e9:1e7:2.9e9);
analyze(CascadedCkt, f);
```

Analyze Simulation Results

In this part of the example, you analyze the results of the simulation by plotting data for the circuit object that represents the cascaded amplifier network.

- 1 Type the following set of commands at the MATLAB prompt to use the `smith` command to plot the S_{11} and S_{22} parameters of the cascaded amplifier network on a Z Smith Chart:

```
figure
lineseries2 = smith(CascadedCkt, 'S11', 'S22', 'z');
lineseries2(1).LineStyle = '-';
lineseries2(1).LineWidth = 1;
lineseries2(2).LineStyle = ':';
lineseries2(2).LineWidth = 1;
legend show
```

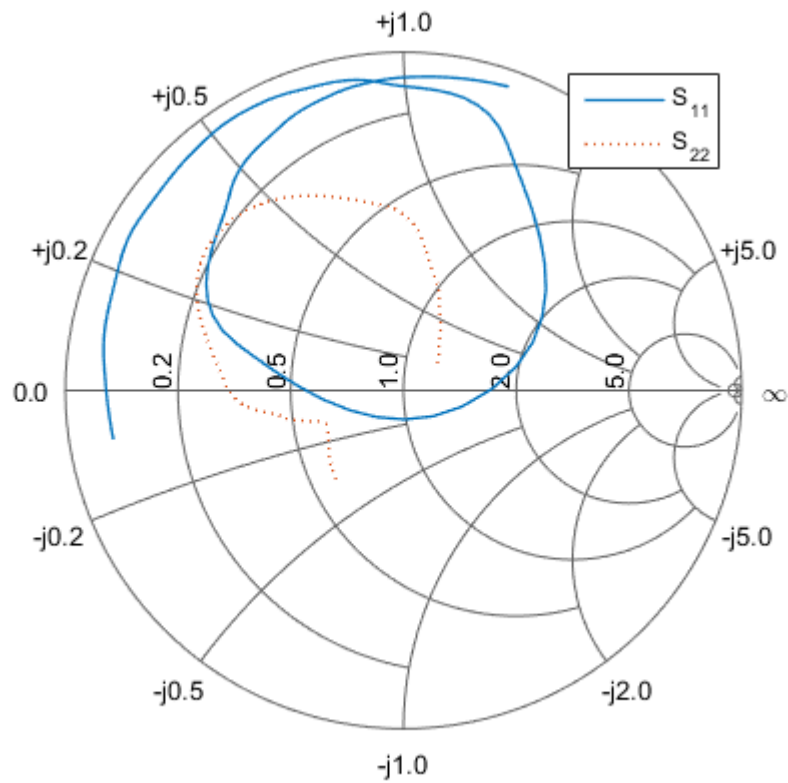
- 2 Type the following set of commands at the MATLAB prompt to use the `plot` command to plot the S_{21} parameter of the cascaded network, which represents the network gain, on an X-Y plane:

```
figure
plot(CascadedCkt, 'S21', 'dB')
legend show
```

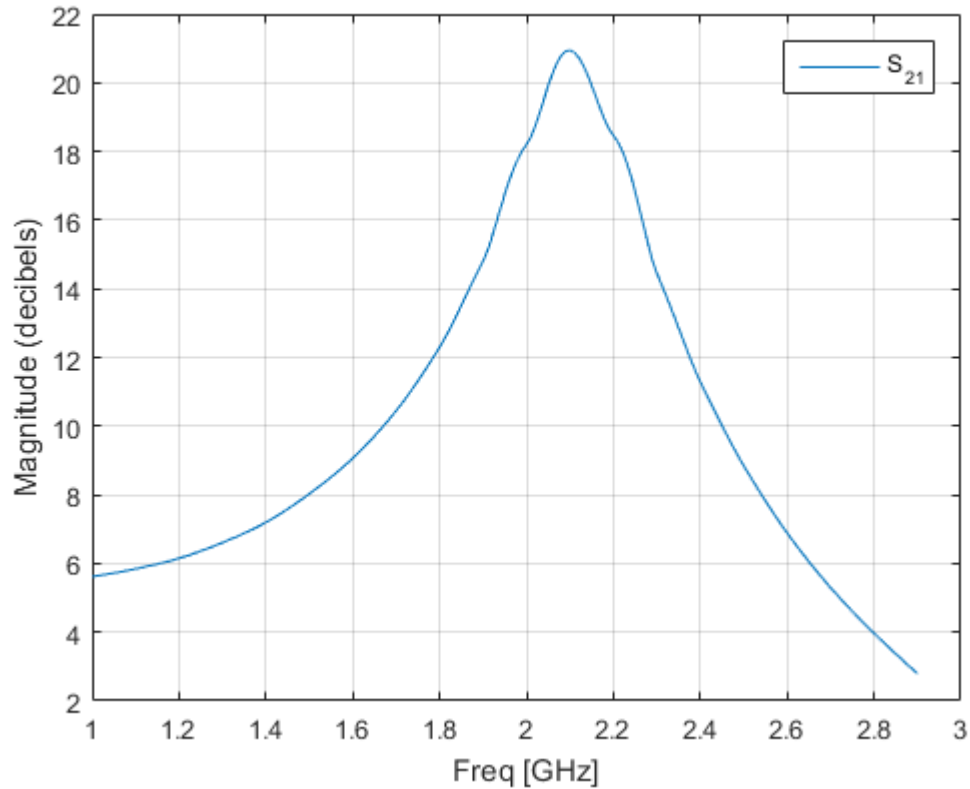

- 3 Type the following set of commands at the MATLAB prompt to use the `plot` command to create a budget plot of the S_{21} parameter and the noise figure of the amplifier network:

```
figure  
plot(CascadedCkt, 'budget', 'S21', 'NF')  
legend show
```

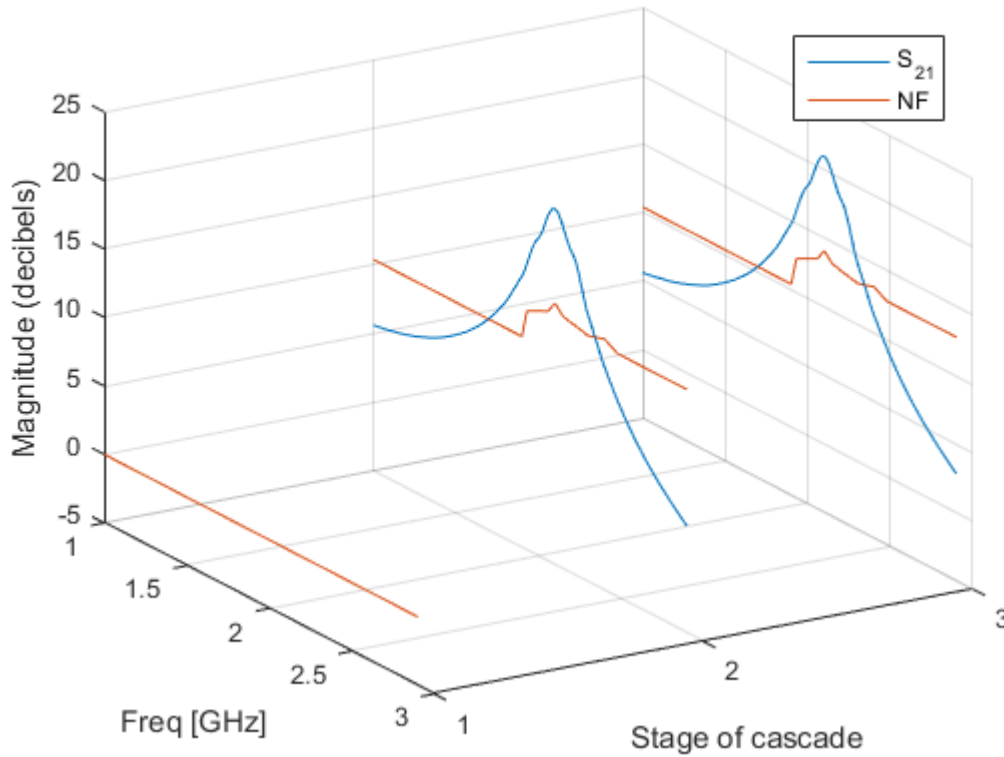

The budget plot shows parameters as a function of frequency by circuit index. Components are indexed based on their position in the network. In this example:

- Circuit index one corresponds to `FirstCkt`.
- Circuit index two corresponds to `SecondCkt`.
- Circuit index three corresponds to `ThirdCkt`.

The curve for each index represents the contributions of the RF components up to and including the component at that index.

Analyze a Transmission Line

In this section...

“Overview” on page 1-18

“Build and Simulate the Transmission Line” on page 1-18

“Compute the Transmission Line Transfer Function and Time-Domain Response” on page 1-18

“Export a Verilog-A Model” on page 1-23

Overview

In this example, you use the RF Toolbox command-line interface to model the time-domain response of a parallel plate transmission line. You analyze the network in the frequency domain, compute and plot the time-domain response of the network, and export a Verilog-A model of the transmission line for use in system-level simulations.

Build and Simulate the Transmission Line

- 1 Type the following command at the MATLAB prompt to create a circuit (`rfckt`) object to represent the transmission line, which is 0.1 meters long and 0.05 meters wide:

```
tline = rfckt.parallelplate('LineLength',0.1,'Width',0.05);
```

- 2 Type the following set of commands at the MATLAB prompt to define the range of frequencies over which to analyze the transmission line and then run the analysis:

```
f = [1.0e9:1e7:2.9e9];  
analyze(tline,f);
```

Compute the Transmission Line Transfer Function and Time-Domain Response

This part of the example illustrates how to perform the following tasks:

- “Calculate the Transfer Function” on page 1-19
- “Fit and Validate the Transfer Function Model” on page 1-19
- “Compute and Plot the Time-Domain Response” on page 1-21

Calculate the Transfer Function

- 1 Type the following command at the MATLAB prompt to extract the computed S-parameter values and the corresponding frequency values for the transmission line:

```
[S_Params, Freq] = extract(tline, 'S_Parameters');
```

- 2 Type the following command at the MATLAB prompt to compute the transfer function from the frequency response data using the `s2tf` function:

```
TrFunc = s2tf(S_Params);
```

Fit and Validate the Transfer Function Model

In this part of the example, you fit a rational function model to the transfer function. The toolbox stores the fitting results in an `rfmodel` object. You use the RF Toolbox `freqresp` method to validate the fit of the rational function model.

- 1 Type the following command at the MATLAB prompt to fit a rational function to the computed data and store the result in an `rfmodel` object:

```
RationalFunc = rationalfit(Freq, TrFunc)
```

```
RationalFunc =
```

```
rfmodel.rational with properties:
```

```
    A: [7x1 double]
```

```
    C: [7x1 double]
```

```
    D: 0
```

```
Delay: 0
```

```
    Name: 'Rational Function'
```

- 2 Type the following command at the MATLAB prompt to compute the frequency response of the fitted model data:

```
[fresp, freq] = freqresp(RationalFunc, Freq);
```

- 3 Type the following set of commands at the MATLAB prompt to plot the amplitude of the frequency response of the fitted model data and that of the computed data:

```
figure
```

```
plot(freq/1e9, 20*log10(abs(fresp)), freq/1e9, 20*log10(abs(TrFunc)))
```

```
xlabel('Frequency, GHz')
```

```
ylabel('Amplitude, dB')  
legend('Fitted Model Data','Computed Data')
```

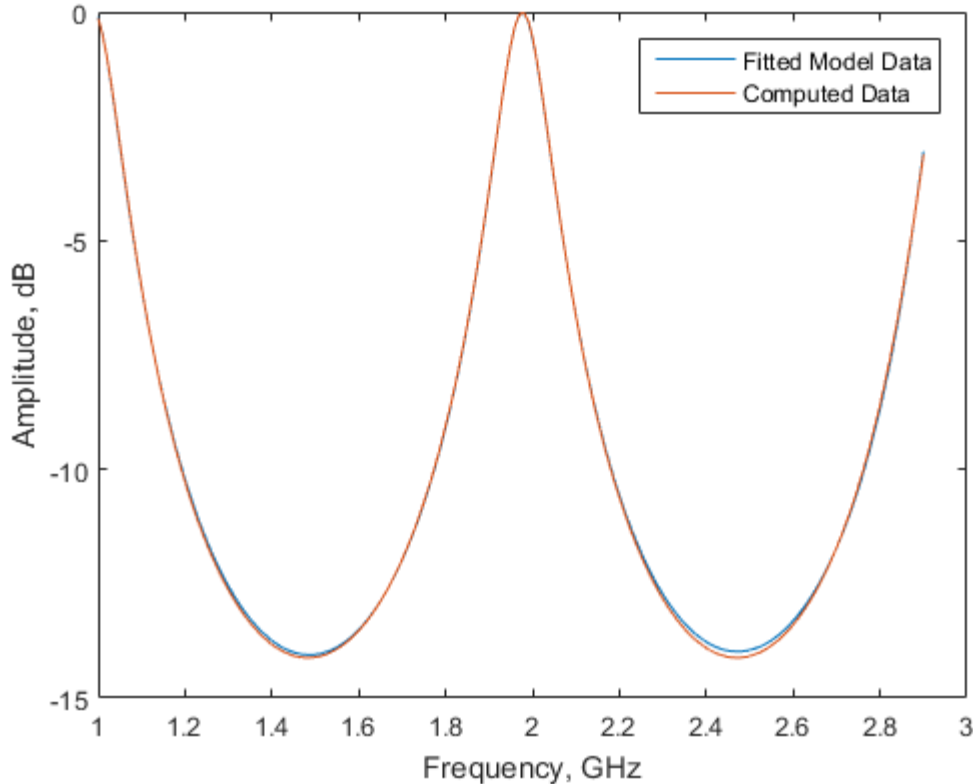

Note: The amplitude of the model data is very close to the amplitude of the computed data. You can control the tradeoff between model accuracy and model complexity by specifying the optional tolerance argument, `tol`, to the `rationalfit` function, as described in “Represent a Circuit Object with a Model Object” on page 4-4.

- 4 Type the following set of commands at the MATLAB prompt to plot the phase angle of the frequency response of the fitted model data and that of the computed data:

```
figure  
plot(freq/1e9,unwrap(angle(fresp)),...
```

```
    freq/1e9,unwrap(angle(TrFunc)))  
xlabel('Frequency, GHz')  
ylabel('Phase Angle, radians')  
legend('Fitted Data','Computed Data')
```

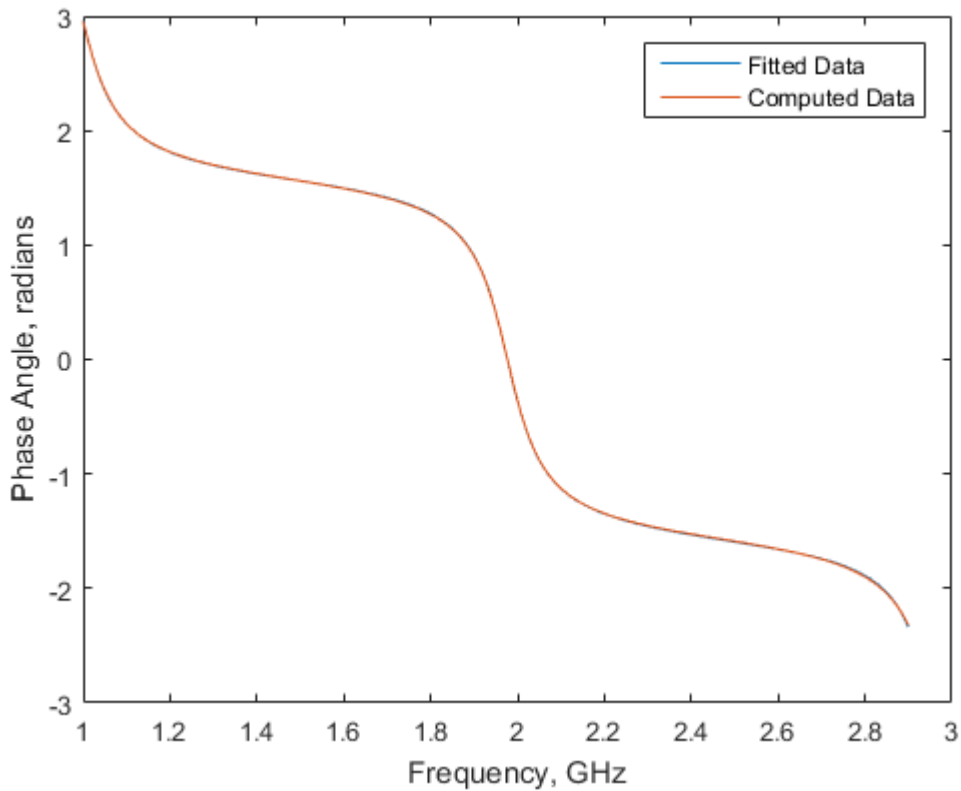

Note: The phase angle of the model data is very close to the phase angle of the computed data.

Compute and Plot the Time-Domain Response

In this part of the example, you compute and plot the time-domain response of the transmission line.

- 1 Type the following set of commands at the MATLAB prompt to create a random input signal and compute the time response, `tresp`, of the fitted model data to the input signal:

```
SampleTime = 1e-12;  
NumberOfSamples = 1e4;  
OverSamplingFactor = 25;  
InputTime = double((1:NumberOfSamples)')*SampleTime;  
InputSignal = ...  
    sign(randn(1, ceil(NumberOfSamples/OverSamplingFactor)));  
InputSignal = repmat(InputSignal, [OverSamplingFactor, 1]);  
InputSignal = InputSignal(:);
```

```
[tresp,t] = timeresp(RationalFunc,InputSignal,SampleTime);
```

- 2 Type the following set of commands at the MATLAB prompt to plot the time response of the fitted model data:

```
figure  
plot(t,tresp)  
xlabel('Time (seconds)')  
ylabel('Response to Random Input Signal')
```

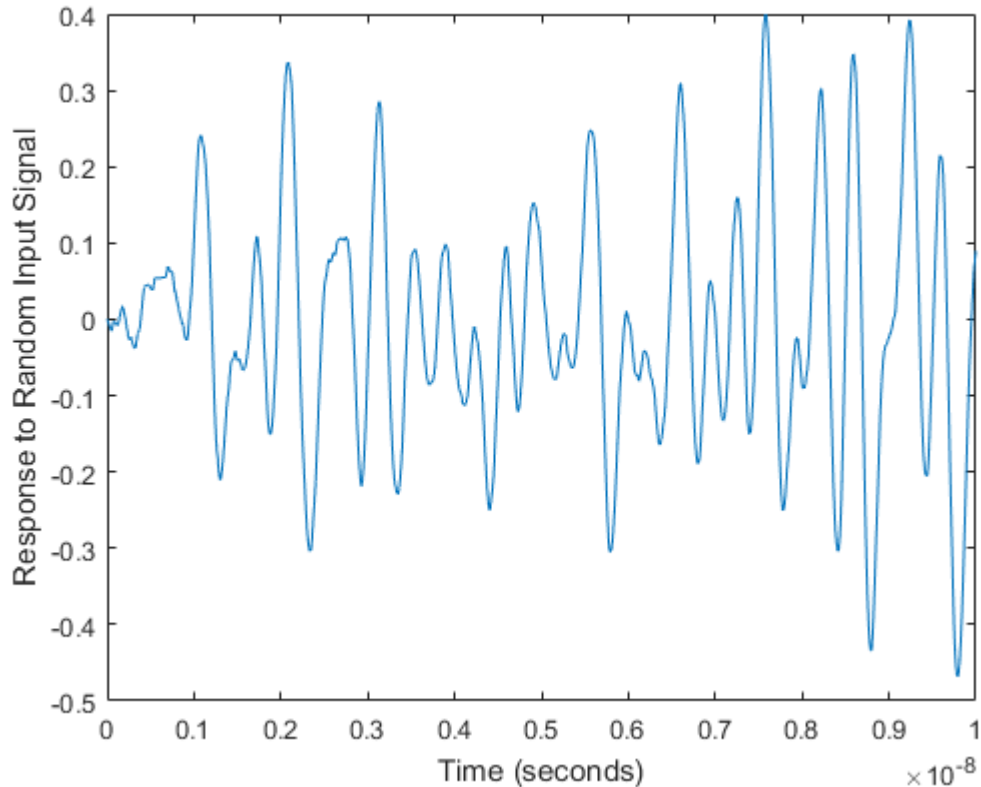
Export a Verilog-A Model

In this part of the example, you export a Verilog-A model of the transmission line. You can use this model in other simulation tools for detailed time-domain analysis and system simulations.

The following code illustrates how to use the `writeva` method to write a Verilog-A module for `RationalFunc` to the file `tline.va`. The module has one input, `tline_in`, and one output, `tline_out`. The method returns a `status` of `True`, if the operation is successful, and `False` if it is unsuccessful.

```
status = writeva(RationalFunc,'tline','tline_in','tline_out')
```

For more information on the `writeva` method and its arguments, see the `writeva` reference page. For more information on Verilog-A models, see “Export a Verilog-A Model” on page 4-4.

RF Objects

- “RF Data Objects” on page 2-2
- “RF Circuit Objects” on page 2-4
- “RF Model Objects” on page 2-9
- “RF Network Parameter Objects” on page 2-11

RF Data Objects

In this section...
“Overview” on page 2-2
“Types of Data” on page 2-2
“Available Data Objects” on page 2-2
“Data Object Methods” on page 2-3

Overview

RF Toolbox software uses data (`rfddata`) objects to store:

- Component data created from files or from information that you specify in the MATLAB workspace.
- Analyzed data from a frequency-domain simulation of a circuit object.

You can perform basic tasks, such as plotting and network parameter conversion, on the data stored in these objects. However, data objects are primarily used to store data for use by other RF objects.

Types of Data

The toolbox uses RF data objects to store one or more of the following types of data:

- Network parameters
- Spot noise
- Noise figure
- Third-order intercept point (IP3)
- Power out versus power in

Available Data Objects

The following table lists the available `rfddata` object constructors and describes the data the corresponding objects represent. For more information on a particular object, follow the link in the table to the reference page for that object.

Constructor	Description
<code>rfdata.data</code>	Data object containing network parameter data
<code>rfdata.ip3</code>	Data object containing IP3 information
<code>rfdata.mixerspur</code>	Data object containing mixer spur information from an intermodulation table
<code>rfdata.network</code>	Data object containing network parameter information
<code>rfdata.nf</code>	Data object containing noise figure information
<code>rfdata.noise</code>	Data object containing noise information
<code>rfdata.power</code>	Data object containing power and phase information

Data Object Methods

The following table lists the methods of the data objects, the types of objects on which each can act, and the purpose of each method.

Method	Types of Objects	Purpose
<code>extract</code>	<code>rfdata.data</code> , <code>rfdata.network</code>	Extract specified network parameters from a circuit or data object and return the result in an array
<code>read</code>	<code>rfdata.data</code>	Read RF data parameters from a file to a new or existing data object.
<code>write</code>	<code>rfdata.data</code>	Write RF data from a data object to a file.

RF Circuit Objects

In this section...
“Overview of RF Circuit Objects” on page 2-4
“Components Versus Networks” on page 2-4
“Available Components and Networks” on page 2-5
“Circuit Object Methods” on page 2-6

Overview of RF Circuit Objects

RF Toolbox software uses circuit (`rfckt`) objects to represent the following components:

- Circuit components such as amplifiers, transmission lines, and ladder filters
- RLC network components
- Networks of RF components

The toolbox represents each type of component and network with a different object. You use these objects to analyze components and networks in the frequency domain.

Components Versus Networks

You define component behavior using network parameters and physical properties.

To specify an individual RF component:

- 1 Construct a circuit object to represent the component.
- 2 Specify or import component data.

You define network behavior by specifying the components that make up the network. These components can be either individual components (such as amplifiers and transmission lines) or other networks.

To specify an RF network:

- 1 Build circuit objects to represent the network components.
- 2 Construct a circuit object to represent the network.

Note: This object defines how to connect the network components. However, the network is empty until you specify the components that it contains.

- 3 Specify, as the `Ckts` property of the object that represents the network, a list of components that make up the network.

These procedures are illustrated by example in “Model a Cascaded RF Network” on page 1-10.

Available Components and Networks

To create circuit objects that represent components, you use constructors whose names describe the components. To create circuit objects that represent networks, you use constructors whose names describe how the components are connected together.

The following table lists the available `rfckt` object constructors and describes the components or networks the corresponding objects represent. For more information on a particular object, follow the link in the table to the reference page for that object.

Constructor	Description
<code>rfckt.amplifier</code>	Amplifier, described by an <code>rfdata</code> object
<code>rfckt.cascade</code>	Cascaded network, described by the list of components and networks that comprise it
<code>rfckt.coaxial</code>	Coaxial transmission line, described by dimensions and electrical characteristics
<code>rfckt.cpw</code>	Coplanar waveguide transmission line, described by dimensions and electrical characteristics
<code>rfckt.datafile</code>	General circuit, described by a data file
<code>rfckt.delay</code>	Delay line, described by loss and delay
<code>rfckt.hybrid</code>	Hybrid connected network, described by the list of components and networks that comprise it
<code>rfckt.hybridg</code>	Inverse hybrid connected network, described by the list of components and networks that comprise it
<code>rfckt.lcbandpasspi</code>	LC bandpass pi network, described by LC values
<code>rfckt.lcbandpasstee</code>	LC bandpass tee network, described by LC values

Constructor	Description
<code>rfckt.lcbandstoppi</code>	LC bandstop pi network, described by LC values
<code>rfckt.lcbandstoptee</code>	LC bandstop tee network, described by LC values
<code>rfckt.lchighpasspi</code>	LC highpass pi network, described by LC values
<code>rfckt.lchighpasstee</code>	LC highpass tee network, described by LC values
<code>rfckt.lclowpasspi</code>	LC lowpass pi network, described by LC values
<code>rfckt.lclowpasstee</code>	LC lowpass tee network, described by LC values
<code>rfckt.microstrip</code>	Microstrip transmission line, described by dimensions and electrical characteristics
<code>rfckt.mixer</code>	Mixer, described by an <code>rfdata</code> object
<code>rfckt.parallel</code>	Parallel connected network, described by the list of components and networks that comprise it
<code>rfckt.parallelplate</code>	Parallel-plate transmission line, described by dimensions and electrical characteristics
<code>rfckt.passive</code>	Passive component, described by network parameters
<code>rfckt.rlcgline</code>	RLCG transmission line, described by RLCG values
<code>rfckt.series</code>	Series connected network, described by the list of components and networks that comprise it
<code>rfckt.seriesrlc</code>	Series RLC network, described by RLC values
<code>rfckt.shuntrlc</code>	Shunt RLC network, described by RLC values
<code>rfckt.twowire</code>	Two-wire transmission line, described by dimensions and electrical characteristics
<code>rfckt.txline</code>	General transmission line, described by dimensions and electrical characteristics

Circuit Object Methods

The following table lists the methods of the circuit objects, the types of objects on which each can act, and the purpose of each method.

Method	Types of Objects	Purpose
<code>analyze</code>	All circuit objects	Analyze a circuit object in the frequency domain.

Method	Types of Objects	Purpose
calculate	All circuit objects	Calculate specified parameters for a circuit object.
copy	All circuit objects	Copy a circuit or data object.
extract	All circuit objects	Extract specified network parameters from a circuit or data object, and return the result in an array.
getdata	All circuit objects	Get data object containing analyzed result of a specified circuit object.
getz0	rfckt.txline, rfckt.rlcgline, rfckt.twowire, rfckt.parallelplate, rfckt.coaxial, rfdata.microstrip, rfckt.cpw	Get characteristic impedance of a transmission line.
listformat	All circuit objects	List valid formats for a specified circuit object parameter.
listparam	All circuit objects	List valid parameters for a specified circuit object.
loglog	All circuit objects	Plot specified circuit object parameters using a log-log scale.
plot	All circuit objects	Plot the specified circuit object parameters on an X-Y plane.
plotyy	All circuit objects	Plot the specified object parameters with y-axes on both the left and right sides.
polar	All circuit objects	Plot the specified circuit object parameters on polar coordinates.
read	rfckt.datafile, rfckt.passive, rfckt.amplifier, rfckt.mixer	Read RF data from a file to a new or existing circuit object.

Method	Types of Objects	Purpose
restore	rfckt.datafile, rfckt.passive, rfckt.amplifier, rfckt.mixer	Restore data to original frequencies of NetworkData for plotting.
semilogx	All circuit objects	Plot the specified circuit object parameters using a log scale for the X-axis
semilogy	All circuit objects	Plot the specified circuit object parameters using a log scale for the Y-axis
smith	All circuit objects	Plot the specified circuit object parameters on a Smith chart.
write	All circuit objects	Write RF data from a circuit object to a file.

RF Model Objects

In this section...

“Overview of RF Model Objects” on page 2-9

“Available Model Objects” on page 2-9

“Model Object Methods” on page 2-9

Overview of RF Model Objects

RF Toolbox software uses model (`rfmodel`) objects to represent components and measured data mathematically for computing information such as time-domain response. Each type of model object uses a different mathematical model to represent the component.

RF model objects provide a high-level component representation for use after you perform detailed analysis using RF circuit objects. Use RF model objects to:

- Compute time-domain figures of merit for RF components
- Export Verilog-A models of RF components

Available Model Objects

The following table lists the available `rfmodel` object constructors and describes the model the corresponding objects use. For more information on a particular object, follow the link in the table to the reference page for that object.

Constructor	Description
<code>rfmodel.rational</code>	Rational function model

Model Object Methods

The following table lists the methods of the model objects, the types of objects on which each can act, and the purpose of each method.

Method	Types of Objects	Purpose
<code>freqresp</code>	All model objects	Compute the frequency response of a model object.

Method	Types of Objects	Purpose
timeresp	All model objects	Compute the time response of a model object.
writeva	All model objects	Write data from a model object to a file.

RF Network Parameter Objects

In this section...

“Overview of Network Parameter Objects” on page 2-11

“Available Network Parameter Objects” on page 2-11

“Network Parameter Object Functions” on page 2-11

Overview of Network Parameter Objects

RF Toolbox software offers network parameter objects for:

- Importing network parameter data from a Touchstone file.
- Converting network parameters.
- Analyzing network parameter data.

Unlike circuit, model, and data objects, you can use existing RF Toolbox functions to operate directly on network parameter objects.

Available Network Parameter Objects

The following table lists the available network parameter objects and the functions that are used to construct them. For more information on a particular object, follow the link in the table to the reference page for that functions.

Network Parameter Object Type	Network Parameter Object Function
ABCD Parameter object	abcdparameters
Hybrid-g parameter object	gparameters
Hybrid parameter object	hparameters
S-parameter object	sparameters
Y-parameter object	yparameters
Z-parameter object	zparameters

Network Parameter Object Functions

The following table lists the functions that accept network parameter objects as inputs, the types of objects on which each can act, and the purpose of each function.

Function	Types of Objects	Purpose
abcdparameters	All network parameter objects	Convert any network parameters to ABCD parameters
gparameters	All network parameter objects	Convert any network parameters to hybrid-g parameters
hparameters	All network parameter objects	Convert any network parameters to hybrid parameters
sparameters	All network parameter objects	Convert any network parameters to S-parameters
yparameters	All network parameter objects	Convert any network parameters to Y-parameters
zparameters	All network parameter objects	Convert any network parameters to Z-parameters
cascadesparams	S-parameter objects	Cascade S-parameters
deembedsparams	S-parameter objects	De-embed S-parameters
gammain	S-parameter objects	Calculate input reflection coefficient
gammaml	S-parameter objects	Calculate load reflection coefficient
gammams	S-parameter objects	Calculate source reflection coefficient
gammaout	S-parameter objects	Calculate output reflection coefficient
ispassive	S-parameter objects	Check S-parameter data passivity
makepassive	S-parameter objects	Make S-parameter data passive
newref	S-parameter objects	Change reference impedance
powergain	S-parameter objects	Calculate power gain
rfplot	S-parameter objects	Plot network parameters

Function	Types of Objects	Purpose
rfinterp1	All network parameter objects	Interpolate network parameters at new frequencies
rfparam	All network parameter objects	Extract vector of network parameters
s2tf	S-parameter objects	Create transfer function from S-parameters
stabilityk	S-parameter objects	Calculate stability factor K of 2-port network
stabilitymu	S-parameter objects	Calculate stability factor μ of 2-port network
smith	All network parameter objects	Plot network parameter data on a Smith Chart

Model an RF Component

- “Create RF Objects” on page 3-2
- “Specify or Import Component Data” on page 3-5
- “Specify Operating Conditions” on page 3-16
- “Process File Data for Analysis” on page 3-18
- “Analyze and Plot RF Components” on page 3-23
- “Export Component Data to a File” on page 3-35
- “Basic Operations with RF Objects” on page 3-38

Create RF Objects

In this section...
“Construct a New Object” on page 3-2
“Copy an Existing Object” on page 3-3

Construct a New Object

You can create any `rfdata`, `rfckt` or `rfmodel` object by calling the object constructor. You can create an `rfmodel` object by fitting a rational function to passive component data.

This section contains the following topics:

- “Call the Object Constructor” on page 3-2
- “Fit a Rational Function to Passive Component Data” on page 3-3

Call the Object Constructor

To create a new RF object with default property values, you call the object constructor without any arguments:

```
h = objecttype.objectname
```

where:

- `h` is the handle to the new object.
- `objecttype` is the object type (`rfdata`, `rfckt`, or `rfmodel`).
- `objectname` is the object name.

For example, to create an RLCG transmission line object, type:

```
h = rfckt.rlcgline
```

because the RLCG transmission line object is a circuit (`rfckt`) object named `rlcgline`.

The following code illustrates how to call the object constructor to create a microstrip transmission line object with default property values. The output `t1` is the handle of the newly created transmission line object.

```
t1 = rfckt.microstrip
```

RF Toolbox software lists the properties of the transmission line you created along with the associated default property values.

```
t1 =  
    Name: 'Microstrip Transmission Line'  
    nPort: 2  
    AnalyzedResult: []  
    LineLength: 0.0100  
    StubMode: 'NotAStub'  
    Termination: 'NotApplicable'  
    Width: 6.0000e-004  
    Height: 6.3500e-004  
    Thickness: 5.0000e-006  
    EpsilonR: 9.8000  
    SigmaCond: Inf  
    LossTangent: 0
```

The `rfckt.microstrip` reference page describes these properties in detail.

Fit a Rational Function to Passive Component Data

You can create a model object by fitting a rational function to passive component data. You use this approach to create a model object that represents one of the following using a rational function:

- A circuit object that you created and analyzed.
- Data that you imported from a file.

For more information, see “Fit a Model Object to Circuit Object Data” on page 3-32.

Copy an Existing Object

You can create a new object with the same property values as an existing object by using the `copy` function to copy the existing object. This function is useful if you have an object that is similar to one you want to create.

For example,

```
t2 = copy(t1);
```

creates a new object, `t2`, which has the same property values as the microstrip transmission line object, `t1`.

You can later change specific property values for this copy. For information on modifying object properties, see “Specify or Import Component Data” on page 3-5.

Note: The syntax `t2 = t1` copies only the object handle and does not create a new object.

Specify or Import Component Data

In this section...

“RF Object Properties” on page 3-5

“Set Property Values” on page 3-5

“Import Property Values from Data Files” on page 3-8

“Use Data Objects to Specify Circuit Properties” on page 3-10

“Retrieve Property Values” on page 3-13

“Reference Properties Directly Using Dot Notation” on page 3-14

RF Object Properties

Object properties specify the behavior of an object. You can specify object properties, or you can import them from a data file. To learn about properties that are specific to a particular type of circuit, data, or model object, see the reference page for that type of object.

Note: The “RF Circuit Objects” on page 2-4, “RF Data Objects” on page 2-2, “RF Model Objects” on page 2-9 sections list the available types of objects and provide links to their reference pages.

Set Property Values

You can specify object property values when you construct an object or you can modify the property values of an existing object.

This section contains the following topics:

- “Specify Property Values at Construction” on page 3-5
- “Change Property Values of an Existing Object” on page 3-7

Specify Property Values at Construction

To set a property when you construct an object, include a comma-separated list of one or more property/value pairs in the argument list of the object construction command.

A property/value pair consists of the arguments '*PropertyName*' ,*PropertyValue*, where:

- *PropertyName* is a string specifying the property name. The name is case-insensitive. In addition, you need only type enough letters to uniquely identify the property name. For example, 'st' is sufficient to refer to the **StubMode** property.

Note: You must use single quotation marks around the property name.

- *PropertyValue* is the value to assign to the property.

Include as many property names in the argument list as there are properties you want to set. Any property values that you do not set retain their default values. The circuit and data object reference pages list the valid values as well as the default value for each property.

This section contains examples of how to perform the following tasks:

- “Construct Components with Specified Properties” on page 3-6
- “Construct Networks of Specified Components” on page 3-7

Construct Components with Specified Properties

The following code creates a coaxial transmission line circuit object to represent a coaxial transmission line that is 0.05 meters long. Notice that the toolbox lists the available properties and their values.

```
t1 = rfckt.coaxial('LineLength',0.05)

t1 =

        Name: 'Coaxial Transmission Line'
        nPort: 2
AnalyzedResult: []
        LineLength: 0.0500
        StubMode: 'NotASTub'
        Termination: 'NotApplicable'
        OuterRadius: 0.0026
        InnerRadius: 7.2500e-004
            MuR: 1
        EpsilonR: 2.3000
        LossTangent: 0
        SigmaCond: Inf
```

Construct Networks of Specified Components

To combine a set of RF components and existing networks to form an RF network, you create a network object with the `Ckts` property set to an array containing the handles of all the circuit objects in the network.

Suppose you have the following RF components:

```
t1 = rfckt.coaxial('LineLength',0.05);
a1 = rfckt.amplifier;
t2 = rfckt.coaxial('LineLength',0.1);
```

The following code creates a cascaded network of these components:

```
casc_network = rfckt.cascade('Ckts',{t1,a1,t2});
```

Change Property Values of an Existing Object

There are two ways to change the properties of an existing object:

- Using the `set` command
- Using structure-like assignments called dot notation

This section discusses the first option. For details on the second option, see “Reference Properties Directly Using Dot Notation” on page 3-14.

To modify the properties of an existing object, use the `set` command with one or more property/value pairs in the argument list. The general syntax of the command is

```
set(h,'Property1',value1,'Property2',value2,...)
```

where

- `h` is the handle of the object.
- `'Property1',value1,'Property2',value2,...` is the list of property/value pairs.

For example, the following code creates a default coaxial transmission line object and changes it to a series stub with open termination.

```
t1 = rfckt.coaxial;
set(t1,'StubMode','series','Termination','open')
```

Note: You can use the `set` command without specifying any property/value pairs to display a list of all properties you can set for a specific object. This example lists the properties you can set for the coaxial transmission line `t1`:

```
set(t1)

ans =
    LineLength: {}
      StubMode: {}
  Termination: {}
  OuterRadius: {}
  InnerRadius: {}
         MuR: {}
     EpsilonR: {}
  LossTangent: {}
  SigmaCond: {}
```

Import Property Values from Data Files

RF Toolbox software lets you import industry-standard data files, MathWorks AMP files, and Agilent P2D and S2D files into specific objects. This import capability lets you simulate the behavior of measured components.

You can import the following file formats:

- Industry-standard file formats — Touchstone SNP, YNP, ZNP, HNP, and GNP formats specify the network parameters and noise information for measured and simulated data.

For more information on Touchstone files, see www.vhdl.org/pub/ibis/connector/touchstone_spec11.pdf.

- Agilent P2D file format — Specifies amplifier and mixer large-signal, power-dependent network parameters, noise data, and intermodulation tables for several operating conditions, such as temperature and bias values.

The P2D file format lets you import system-level verification models of amplifiers and mixers.

- Agilent S2D file format — Specifies amplifier and mixer network parameters with gain compression, power-dependent S_{21} parameters, noise data, and intermodulation tables for several operating conditions.

The S2D file format lets you import system-level verification models of amplifiers and mixers.

- MathWorks amplifier (AMP) file format — Specifies amplifier network parameters, output power versus input power, noise data and third-order intercept point.

For more information about `.amp` files, see “AMP File Data Sections” on page 9-2.

This section contains the following topics:

- “Objects Used to Import Data from a File” on page 3-9
- “How to Import Data Files” on page 3-9

Objects Used to Import Data from a File

One data object and three circuit objects accept data from a file. The following table lists the objects and any corresponding data format each supports.

Object	Description	Supported Format(s)
<code>rfdata.data</code>	Data object containing network parameter data, noise figure, and third-order intercept point	Touchstone, AMP, P2D, S2D
<code>rfckt.amplifier</code>	Amplifier	Touchstone, AMP, P2D, S2D
<code>rfckt.mixer</code>	Mixer	Touchstone, AMP, P2D, S2D
<code>rfckt.passive</code>	Generic passive component	Touchstone

How to Import Data Files

To import file data into a circuit or data object at construction, use a `read` command of the form:

```
obj = read(obj_type, 'filename');
```

where

- `obj` is the handle of the circuit or data object.

- *obj_type* is the type of object in which to store the data, from the list of objects that accept file data shown in “Objects Used to Import Data from a File” on page 3-9.
- *filename* is the name of the file that contains the data.

For example,

```
ckt_obj=read(rfckt.amplifier, 'default.amp');
```

imports data from the file `default.amp` into an `rfckt.amplifier` object.

You can also import file data into an existing circuit object. The following commands are equivalent to the previous command:

```
ckt_obj=rfckt.amplifier;  
read(ckt_obj, 'default.amp');
```

Note: When you import component data from a `.p2d` or `.s2d` file, properties are defined for several operating conditions. You must select an operating condition to specify the object behavior, as described in “Specify Operating Conditions” on page 3-16.

Use Data Objects to Specify Circuit Properties

To specify a circuit object property using a data object, use the `set` command with the name of the data object as the value in the property/value pair.

For example, suppose you have the following `rfckt.amplifier` and `rfdata.nf` objects:

```
amp = rfckt.amplifier  
f = 2.0e9;  
nf = 13.3244;  
nfdata = rfdata.nf('Freq',f,'Data',nf)
```

The following command uses the `rfdata.nf` data object to specify the `rfckt.amplifier` `NoiseData` property:

```
set(amp,'NoiseData',nfdata)
```

Set Circuit Object Properties Using Data Objects

In this example, you create a circuit object. Then, you create three data objects and use them to update the properties of the circuit object.

- 1 Create an amplifier object.** This circuit object, `rfckt.amplifier`, has a network parameter, noise data, and nonlinear data properties. These properties control the frequency response of the amplifier, which is stored in the `AnalyzedResult` property. By default, all amplifier properties contain values from the `default.amp` file. The `NetworkData` property is an `rfdata.network` object that contains 50-ohm S-parameters. The `NoiseData` property is an `rfdata.noise` object that contains frequency-dependent spot noise data. The `NonlinearData` property is an `rfdata.power` object that contains output power and phase information.

```
amp = rfckt.amplifier
```

The toolbox displays the following output:

```
amp =
      Name: 'Amplifier'
     nPort: 2
AnalyzedResult: [1x1 rfdata.data]
      IntpType: 'Linear'
   NetworkData: [1x1 rfdata.network]
     NoiseData: [1x1 rfdata.noise]
  NonlinearData: [1x1 rfdata.power]
```

- 2 Create a data object that stores network data.** Type the following set of commands at the MATLAB prompt to create an `rfdata.network` object that stores the 2-port Y-parameters at 2.08 GHz, 2.10 GHz, and 2.15 GHz. Later in this example, you use this data object to update the `NetworkData` property of the `rfckt.amplifier` object.

```
f = [2.08 2.10 2.15]*1.0e9;
y(:, :, 1) = [-.0090-.0104i, .0013+.0018i; ...
             -.2947+.2961i, .0252+.0075i];
y(:, :, 2) = [-.0086-.0047i, .0014+.0019i; ...
             -.3047+.3083i, .0251+.0086i];
y(:, :, 3) = [-.0051+.0130i, .0017+.0020i; ...
             -.3335+.3861i, .0282+.0110i];

netdata = rfdata.network('Type', 'Y_PARAMETERS', ...
                        'Freq', f, 'Data', y)
```

The toolbox displays the following output:

```
netdata =
```

```
Name: 'Network parameters'  
Type: 'Y_PARAMETERS'  
Freq: [3x1 double]  
Data: [2x2x3 double]  
Z0: 50
```

- 3 Create a data object that stores noise figure values.** Type the following set of commands at the MATLAB prompt to create a `rfdata.nf` object that contains noise figure values, in dB, at seven different frequencies. Later in this example, you use this data object to update the `NoiseData` property of the `rfckt.amplifier` object.

```
f = [1.93 2.06 2.08 2.10 2.15 2.30 2.40]*1.0e9;  
nf=[12.4521 13.2466 13.6853 14.0612 13.4111 12.9499 13.3244];  
  
nfdata = rfdata.nf('Freq',f,'Data',nf)
```

The toolbox displays the following output:

```
nfdata =  
  
Name: 'Noise figure'  
Freq: [7x1 double]  
Data: [7x1 double]
```

- 4 Create a data object that stores output third-order intercept points.** Type the following command at the MATLAB prompt to create a `rfdata.ip3` object that contains an output third-order intercept point of 8.45 watts, at 2.1 GHz. Later in this example, you use this data object to update the `NonlinearData` property of the `rfckt.amplifier` object.

```
ip3data = rfdata.ip3('Type','OIP3','Freq',2.1e9,'Data',8.45)
```

The toolbox displays the following output:

```
ip3data =  
  
Name: '3rd order intercept'  
Type: 'OIP3'  
Freq: 2.1000e+009  
Data: 8.4500
```

- 5 Update the properties of the amplifier object.** Type the following set of commands at the MATLAB prompt to update the `NetworkData`, `NoiseData`, and `NonlinearData` properties of the amplifier object with the data objects you created in the previous steps:

```
amp.NetworkData = netdata;  
amp.NoiseData = nfddata;  
amp.NonlinearData = ip3data;
```

Retrieve Property Values

You can retrieve one or more property values of an existing object using the `get` command.

This section contains the following topics:

- “Retrieve Specified Property Values” on page 3-13
- “Retrieve All Property Values” on page 3-14

Retrieve Specified Property Values

To retrieve specific property values for an object, use the `get` command with the following syntax:

```
PropertyValue = get(h,PropertyName)
```

where

- *PropertyValue* is the value assigned to the property.
- *h* is the handle of the object.
- *PropertyName* is a string specifying the property name.

For example, suppose you have the following coaxial transmission line:

```
h2 = rfckt.coaxial;
```

The following code retrieves the value of the inner radius and outer radius for the coaxial transmission line:

```
ir = get(h2,'InnerRadius')  
or = get(h2,'OuterRadius')
```

```
ir =  
    7.2500e-004
```

```
or =
```

0.0026

Retrieve All Property Values

To display a list of properties associated with a specific object as well as their current values, use the `get` command without specifying a property name.

For example:

```
get(h2)
      Name: 'Coaxial Transmission Line'
      nPort: 2
AnalyzedResult: []
      LineLength: 0.0100
      StubMode: 'NotAStub'
      Termination: 'NotApplicable'
      OuterRadius: 0.0026
      InnerRadius: 7.2500e-004
      MuR: 1
      EpsilonR: 2.3000
      LossTangent: 0
      SigmaCond: Inf
```

Note: This list includes read-only properties that do not appear when you type `set(h2)`. For a coaxial transmission line object, the read-only properties are `Name`, `nPort`, and `AnalyzedResult`. The `Name` and `nPort` properties are fixed by the toolbox. The `AnalyzedResult` property value is calculated and set by the toolbox when you analyze the component at specified frequencies.

Reference Properties Directly Using Dot Notation

An alternative way to query for or modify property values is by structure-like referencing. The field names for RF objects are the property names, so you can retrieve or modify property values with the structure-like syntax.

- `PropertyValue = rfobj.PropertyName` stores the value of the `PropertyName` property of the `rfobj` object in the `PropertyValue` variable. This command is equivalent to `PropertyValue = get(rfobj, 'PropertyName')`.
- `rfobj.PropertyName = PropertyValue` sets the value of the `PropertyName` property to `PropertyValue` for the `rfobj` object. This command is equivalent to `set(rfobj, 'PropertyName', PropertyValue)`.

For example, typing

```
ckt = rfckt.amplifier('IntpType','cubic');  
ckt.IntpType
```

gives the value of the property `IntpType` for the circuit object `ckt`.

```
ans =  
    Cubic
```

Similarly,

```
ckt.IntpType = 'linear';
```

resets the interpolation method to linear.

You do not need to type the entire field name or use uppercase characters. You only need to type the minimum number of characters sufficient to identify the property name uniquely. Thus entering the commands

```
ckt = rfckt.amplifier('IntpType','cubic');  
ckt.in
```

also produces

```
ans =  
    Cubic
```

Specify Operating Conditions

In this section...

“Available Operating Conditions” on page 3-16

“Set Operating Conditions” on page 3-16

“Display Available Operating Condition Values” on page 3-17

Available Operating Conditions

Agilent P2D and S2D files contain simulation results at one or more operating conditions. Operating conditions define the independent parameter settings that are used when creating the file data. The specified conditions differ from file to file.

When you import component data from a .p2d or .s2d file, the object contains property values for several operating conditions. The available conditions depend on the data in the file. By default, RF Toolbox software defines the object behavior using the property values that correspond to the operating conditions that appear first in the file. To use other property values, you must select a different operating condition.

Set Operating Conditions

To set the operating conditions of a circuit or data object, use a `setop` command of the form:

```
setop(, 'Condition1', value1, ..., 'ConditionN', valueN, ...)
```

where

- is the handle of the circuit or data object.
- `Condition1, value1, ..., ConditionN, valueN` are the condition/value pairs that specify the operating condition.

For example,

```
setop(myp2d, 'BiasL', 2, 'BiasU', 6.3)
```

specifies an operating condition of `BiasL = 2` and `BiasU = 6.3` for *myp2d*.

Display Available Operating Condition Values

To display a list of available operating condition values for a circuit or data object, use the `setop` method.

```
setop(obj)
```

displays the available values for all operating conditions of the object `obj`.

```
setop(obj, 'Condition1')
```

displays the available values for *Condition1*.

Process File Data for Analysis

In this section...

“Convert Single-Ended S-Parameters to Mixed-Mode S-Parameters” on page 3-18

“Extract M-Port S-Parameters from N-Port S-Parameters” on page 3-19

“Cascade N-Port S-Parameters” on page 3-21

Convert Single-Ended S-Parameters to Mixed-Mode S-Parameters

After you import file data (as described in “Import Property Values from Data Files” on page 3-8), you can convert a matrix of single-ended S-parameter data to a matrix of mixed-mode S-parameters.

This section contains the following topics:

- “Functions for Converting S-Parameters” on page 3-18
- “Convert S-Parameters” on page 3-19

Functions for Converting S-Parameters

To convert between 4-port single-ended S-parameter data and 2-port differential-, common-, and cross-mode S-parameters, use one of these functions:

- **s2scc** — Convert 4-port, single-ended S-parameters to 2-port, common-mode S-parameters (S_{cc}).
- **s2scd** — Convert 4-port, single-ended S-parameters to 2-port, cross-mode S-parameters (S_{cd}).
- **s2sdc** — Convert 4-port, single-ended S-parameters to cross-mode S-parameters (S_{dc}).
- **s2sdd** — Convert 4-port, single-ended S-parameters to 2-port, differential-mode S-parameters (S_{dd}).

To perform the above conversions all at once, or to convert larger data sets, use one of these functions:

- **s2smm** — Convert 4N-port, single-ended S-parameters to 2N-port, mixed-mode S-parameters.

- **smm2s** — Convert 2N-port, mixed-mode S-parameters to 4N-port, single-ended S-parameters.

Conversion functions support a variety of port orderings. For more information on these functions, see the corresponding reference pages.

Convert S-Parameters

In this example, use the toolbox to import 4-port single-ended S-parameter data from a file, convert the data to 2-port differential S-parameter data, and create a new `rfckt` object to store the converted data for analysis.

At the MATLAB prompt:

- 1 Type this command to import data from the file `default.s4p`:

```
SingleEnded4Port = read(rfdata.data, 'default.s4p');
```

- 2 Type this command to convert 4-port single-ended S-parameters to 2-port mixed-mode S-parameters:

```
DifferentialSParams = s2sdd(SingleEnded4Port.S_Parameters);
```

Note: The S-parameters that you specify as input to the `s2sdd` function are the ones the toolbox stores in the `S_Parameters` property of the `rfdata.data` object.

- 3 Type this command to create an `rfckt.passive` object that stores the 2-port differential S-parameters for simulation:

```
DifferentialCkt = rfckt.passive('NetworkData', ...
    rfdata.network('Data', DifferentialSParams, 'Freq', ...
    SingleEnded4PortData.Freq));
```

Extract M-Port S-Parameters from N-Port S-Parameters

After you import file data (as described in “Import Property Values from Data Files” on page 3-8), you can extract a set of data with a smaller number of ports by terminating one or more ports with a specified impedance.

This section contains the following topics:

- “Extract S-Parameters” on page 3-20

- “Extract S-Parameters From Imported File Data” on page 3-21

Extract S-Parameters

To extract M -port S-parameters from N -port S-parameters, use the `snp2smp` function with the following syntax:

```
s_params_mp = snp2smp(s_params_np, z0, n2m_index, zt)
```

where

- s_params_np is an array of N -port S-parameters with a reference impedance $z0$.
- s_params_mp is an array of M -port S-parameters.
- $n2m_index$ is a vector of length M specifying how the ports of the N -port S-parameters map to the ports of the M -port S-parameters. $n2m_index(i)$ is the index of the port from s_params_np that is converted to the i th port of s_params_mp .
- zt is the termination impedance of the ports.

The following figure illustrates how to specify the ports for the output data and the termination of the remaining ports.

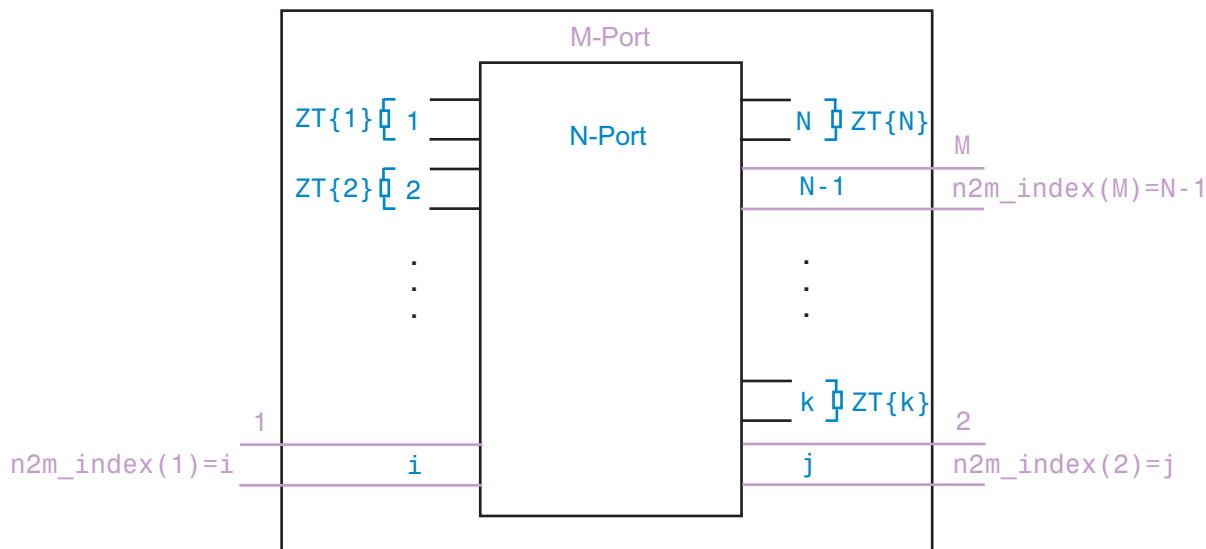

For more details about the arguments to this function, see the `snp2smp` reference page.

Extract S-Parameters From Imported File Data

In this example, use the toolbox to import 16-port S-parameter data from a file, convert the data to 4-port S-parameter data by terminating the remaining ports, and create a new `rfckt` object to store the extracted data for analysis.

At the MATLAB prompt:

- 1 Type this command to import data from the file `default.s16p` into an `rfdata.data` object, `SingleEnded16PortData`:

```
SingleEnded16PortData = read(rfdata.data, 'default.s16p');
```

- 2 Type this command to convert 16-port S-parameters to 4-port S-parameters by using ports 1, 16, 2, and 15 as the first, second, third, and fourth ports, and terminating the remaining 12 ports with an impedance of 50 ohms:

```
N2M_index = [1 16 2 15];
FourPortSPParams = snp2smp(SingleEnded16PortData.S_Parameters, ...
    SingleEnded16PortData.Z0, N2M_index, 50);
```

Note: The S-parameters that you specify as input to the `snp2smp` function are the ones the toolbox stores in the `S_Parameters` property of the `rfdata.data` object.

- 3 Type this command to create an `rfckt.passive` object that stores the 4-port S-parameters for simulation:

```
FourPortChannel = rfckt.passive('NetworkData', ...
    rfdata.network('Data', FourPortSPParams, 'Freq', ...
    SingleEnded16PortData.Freq));
```

Cascade N-Port S-Parameters

After you import file data (as described in “Import Property Values from Data Files” on page 3-8), you can cascade two or more networks of N-port S-parameters.

To cascade networks of N-port S-parameters, use the `cascadesparams` function with the following syntax:

```
s_params = cascadesparams(s1_params, s2_params, ..., sn_params, nconn)
```

where

- `s_params` is an array of cascaded S-parameters.

- *s1_params*, *s2_params*, ..., *sn_params* are arrays of input S-parameters.
- *nconn* is a positive scalar or a vector of size *n*-1 specifying how many connections to make between the ports of the input S-parameters. `cascadesparams` connects the last port(s) of one network to the first port(s) of the next network.

For more details about the arguments to this function, see the `cascadesparams` reference page.

Import and Cascade N-Port S-Parameters

In this example, use the toolbox to import 16-port and 4-port S-parameter file data and cascade the two S-parameter networks by connecting the last three ports of the 16-port network to the first three ports of the 4-port network. Then, create a new `rfckt` object to store the resulting network for analysis.

At the MATLAB prompt:

- 1 Type these commands to import data from the files `default.s16p` and `default.s4p`, and create the 16- and 4-port networks of S-parameters:

```
S_16Port = read(rfdata.data,'default.s16p');  
S_4Port = read(rfdata.data,'default.s4p');  
freq = [2e9 2.1e9];  
analyze(S_16Port, freq);  
analyze(S_4Port, freq);  
sparams_16p = S_16Port.S_Parameters;  
sparams_4p = S_4Port.S_Parameters;
```

- 2 Type this command to cascade 16-port S-parameters and 4-port S-parameters by connecting ports 14, 15, and 16 of the 16-port network to ports 1, 2, and 3 of the 4-port network:

```
sparams_cascaded = cascadesparams(sparams_16p, sparams_4p,3)  
cascadesparams creates a 14-port network. Ports 1–13 are the first 13 ports of the 16-port network. Port 14 is the fourth port of the 4-port network.
```

- 3 Type this command to create an `rfckt.passive` object that stores the 14-port S-parameters for simulation:

```
Ckt14 = rfckt.passive('NetworkData', ...  
    rfdata.network('Data', sparams_cascaded, 'Freq', ...  
    freq));
```

For more examples of how to use this function, see the `cascadesparams` reference page.

Analyze and Plot RF Components

In this section...

“Analyze Networks in the Frequency Domain” on page 3-23

“Visualize Component and Network Data” on page 3-23

“Compute and Plot Time-Domain Specifications” on page 3-32

Analyze Networks in the Frequency Domain

RF Toolbox software lets you analyze RF components and networks in the frequency domain. You use the `analyze` method to analyze a circuit object over a specified set of frequencies.

For example, to analyze a coaxial transmission line from 1 GHz to 2.9 GHz in increments of 10 MHz:

```
ckt = rfckt.coaxial;  
f = [1.0e9:1e7:2.9e9];  
analyze(ckt,f);
```

Note: For all circuits objects except those that contain data from a file, you must perform a frequency-domain analysis with the `analyze` method before visualizing component and network data. For circuits that contain data from a file, the toolbox performs a frequency-domain analysis when you use the `read` method to import the data.

When you analyze a circuit object, the toolbox computes the circuit network parameters, noise figure values, and output third-order intercept point (OIP3) values at the specified frequencies and stores the result of the analysis in the object's `AnalyzedResult` property.

For more information, see the `analyze` reference page or the circuit object reference page.

Visualize Component and Network Data

The toolbox lets you validate the behavior of circuit objects that represent RF components and networks by plotting the following data:

- Large- and small-signal S-parameters
- Noise figure
- Output third-order intercept point
- Power data
- Phase noise
- Voltage standing-wave ratio
- Power gain
- Group delay
- Reflection coefficients
- Stability data
- Transfer function

The following table summarizes the available plots and charts, along with the methods you can use to create each one and a description of its contents.

Plot Type	Methods	Plot Contents
Rectangular Plot	<p>plot</p> <p>plotyy</p> <p>loglog</p> <p>semilogx</p> <p>semilogy</p>	<p>Parameters as a function of frequency or, where applicable, operating condition. The available parameters include:</p> <ul style="list-style-type: none"> • S-parameters • Noise figure • Voltage standing-wave ratio (VSWR) • OIP3
Budget Plot (3-D)	<p>plot</p>	<p>Parameters as a function of frequency for each component in a cascade, where the curve for a given component represents the cumulative contribution of each RF component up to and including the parameter value of that component.</p>
Mixer Spur Plot	<p>plot</p>	<p>Mixer spur power as a function of frequency for an <code>rfckt.mixer</code></p>

Plot Type	Methods	Plot Contents
		object or an <code>rfckt.cascade</code> object that contains a mixer.
Polar Plot	<code>polar</code>	Magnitude and phase of S-parameters as a function of frequency.
Smith Chart	<code>smith</code>	Real and imaginary parts of S-parameters as a function of frequency, used for analyzing the reflections caused by impedance mismatch.

For each plot you create, you choose a parameter to plot and, optionally, a format in which to plot that parameter. The plot format defines how the toolbox displays the data on the plot. The available formats vary with the data you select to plot. The data you can plot depends on the type of plot you create.

Note: You can use the `listparam` method to list the parameters of a specified circuit object that are available for plotting. You can use the `listformat` method to list the available formats for a specified circuit object parameter.

The following topics describe the available plots:

- “Rectangular” on page 3-25
- “Budget” on page 3-26
- “Mixer Spur” on page 3-28
- “Polar Plots and Smith Charts” on page 3-31

Rectangular

You can plot any parameters that are relevant to your object on a rectangular plot. You can plot parameters as a function of frequency for any object. When you import object data from a `.p2d` or `.s2d` file, you can also plot parameters as a function of any operating condition from the file that has numeric values, such as bias. In addition, when you import object data from a `.p2d` file, you can plot large-signal S-parameters as a function of input power or as a function of frequency. These parameters are denoted LS11, LS12, LS21, and LS22.

The following table summarizes the methods that are available in the toolbox for creating rectangular plots and describes the uses of each one. For more information on a particular type of plot, follow the link in the table to the documentation for that method.

Method	Description
<code>plot</code>	Plot of one or more object parameters
<code>plotyy</code>	Plot of one or more object parameters with y-axes on both the left and right sides
<code>semilogx</code>	Plot of one or more object parameters using a log scale for the X-axis
<code>semilogy</code>	Plot of one or more object parameters using a log scale for the Y-axis
<code>loglog</code>	Plot of one or more object parameters using a log-log scale

Budget

You use the link budget plot to understand the individual contribution of each component to a plotted parameter value in a cascaded network with multiple components.

The budget plot is a three-dimensional plot that shows one or more curves of parameter values as a function of frequency, ordered by the circuit index of the cascaded network.

Consider the following cascaded network:

```
casc = rfckt.cascade('Ckts',...
    {rfckt.amplifier,rfckt.lcbandpasspi,rfckt.txline})
```

The following figure shows how the circuit index is assigned to each component in the cascade, based on its sequential position in the network.

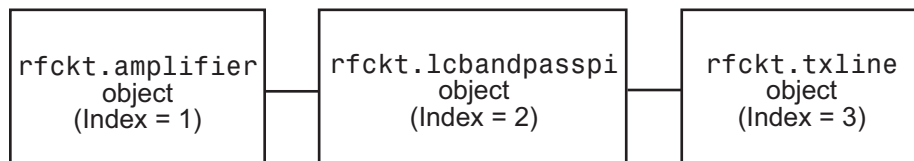

You create a budget plot for this cascade using the `plot` method with the second argument set to `'budget'`, as shown in the following command:

```
plot(casc, 'budget', 's21')
```

A curve on the link budget plot for each circuit index represents the contributions to the parameter value of the RF components up to that index. The following figure shows the budget plot.

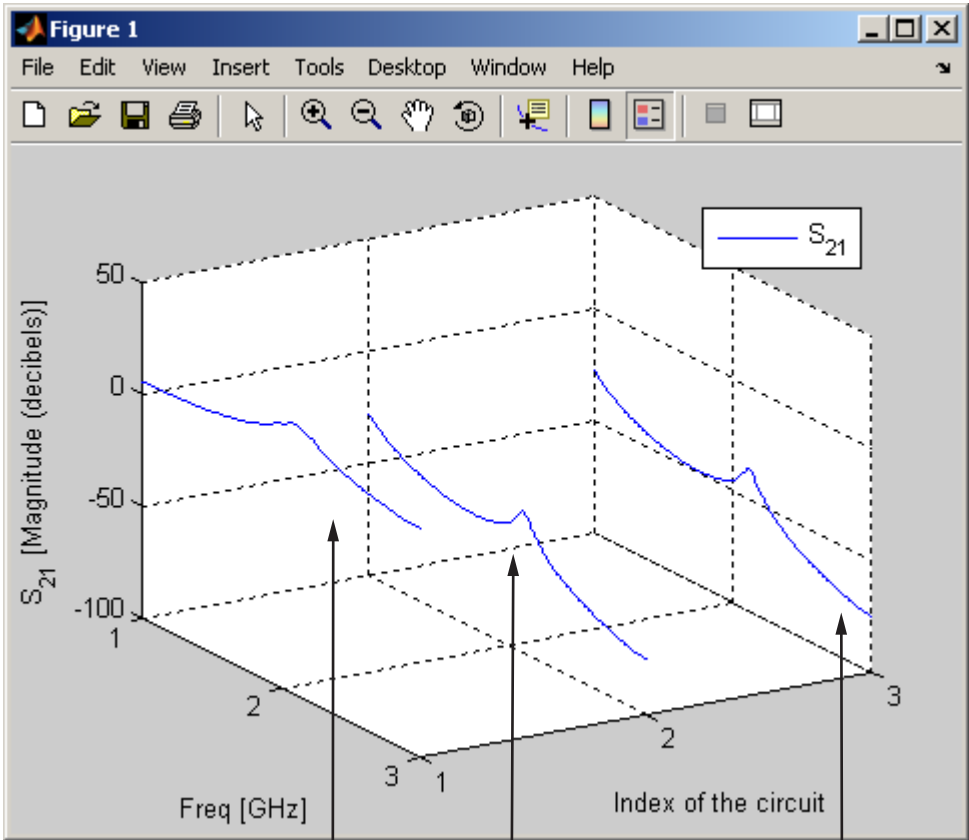

Contributions to S21 from component 1

Contributions to S21 from components 1 and 2

Contributions to S21 from components 1, 2, and 3

Budget Plot

If you specify two or more parameters, the toolbox puts the parameters in a single plot. You can only specify a single format for all the parameters.

Mixer Spur

You use the mixer spur plot to understand how mixer nonlinearities affect output power at the desired mixer output frequency and at the intermodulation products that occur at the following frequencies:

$$f_{out} = N * f_{in} + M * f_{LO}$$

where

- f_{in} is the input frequency.
- f_{LO} is the local oscillator frequency.
- N and M are integers.

The toolbox calculates the output power from the mixer intermodulation table (IMT). These tables are described in detail in the Visualizing Mixer Spurs example.

The mixer spur plot shows power as a function of frequency for an `rfckt.mixer` object or an `rfckt.cascade` object that contains a mixer. By default, the plot is three-dimensional and shows a stem plot of power as a function of frequency, ordered by the circuit index of the object. You can create a two-dimensional stem plot of power as a function of frequency for a single circuit index by specifying the index in the mixer spur plot command.

Consider the following cascaded network:

```
FirstCkt = rfckt.amplifier('NetworkData', ...  
    rfdata.network('Type', 'S', 'Freq', 2.1e9, ...  
    'Data', [0,0;10,0]), 'NoiseData', 0, 'NonlinearData', inf);  
SecondCkt = read(rfckt.mixer, 'samplespur1.s2d');  
ThirdCkt = rfckt.lcbandpasstee('L', [97.21 3.66 97.21]*1e-9, ...  
    'C', [1.63 43.25 1.63]*1.0e-12);  
CascadedCkt = rfckt.cascade('Ckts', ...  
    {FirstCkt, SecondCkt, ThirdCkt});
```

The following figure shows how the circuit index is assigned to the components in the cascade, based on its sequential position in the network.

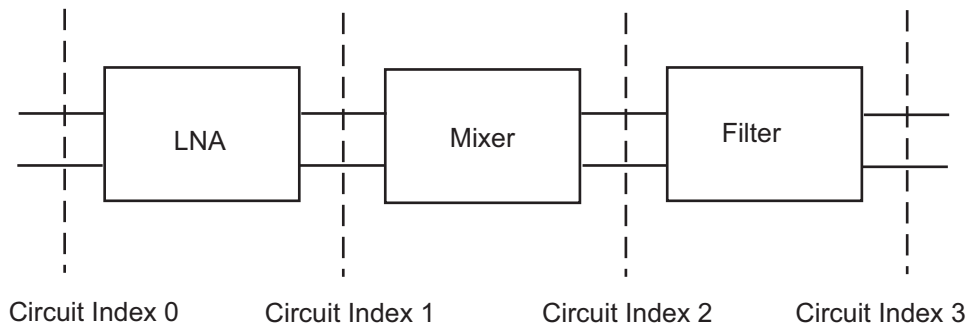

- Circuit index 0 corresponds to the cascade input.
- Circuit index 1 corresponds to the LNA output.
- Circuit index 2 corresponds to the mixer output.
- Circuit index 3 corresponds to the filter output.

You create a spur plot for this cascade using the `plot` method with the second argument set to `'mixerspurs'`, as shown in the following command:

```
plot(CascadedCkt, 'mixerspurs')
```

Within the three dimensional plot, the stem plot for each circuit index represents the power at that circuit index. The following figure shows the mixer spur plot.

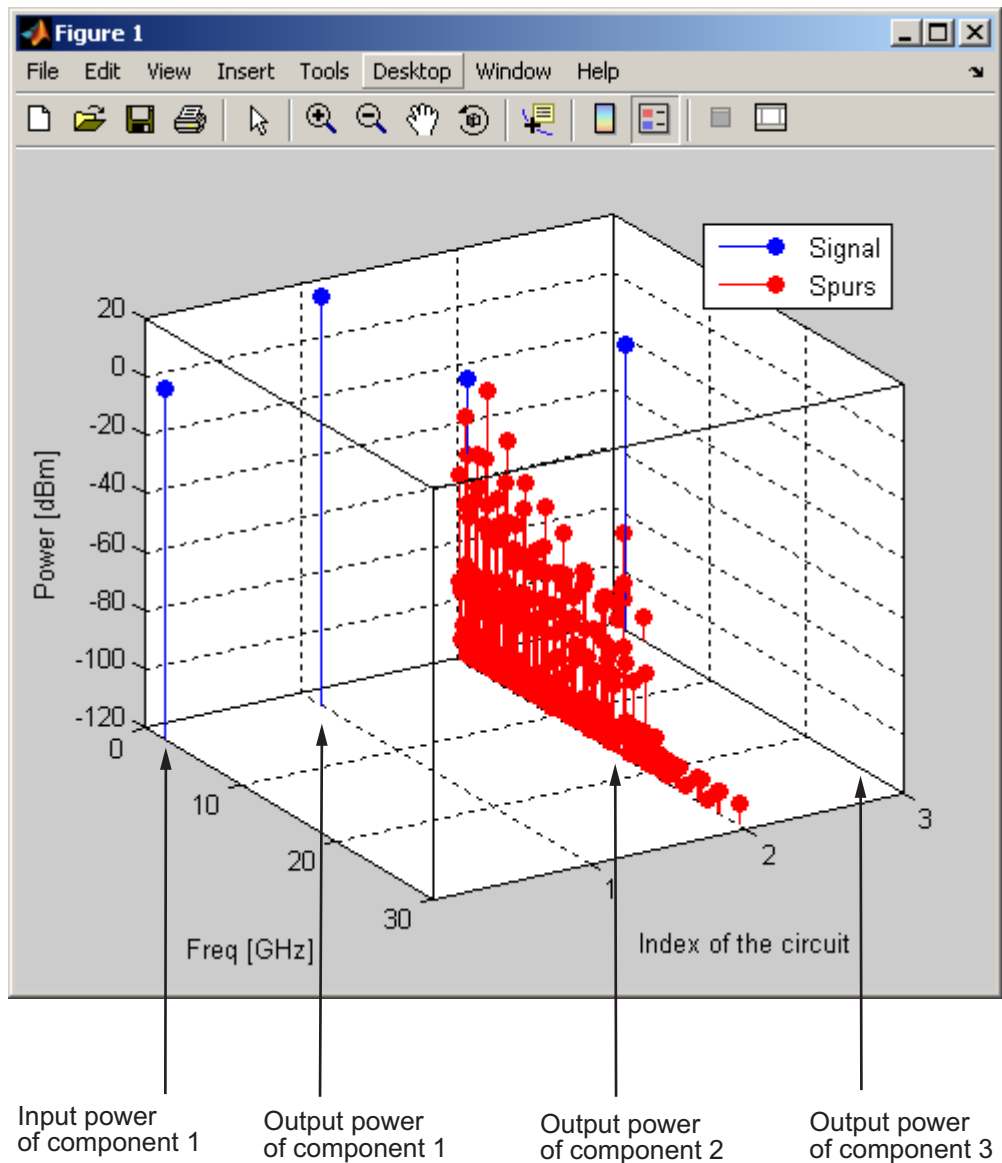

Mixer Spur Plot

For more information on mixer spur plots, see the `plot` reference page.

Polar Plots and Smith Charts

You can use the toolbox to generate Polar plots and Smith Charts. If you specify two or more parameters, the toolbox puts the parameters in a single plot.

The following table describes the Polar plot and Smith Chart options, as well as the available parameters.

Note: LS11, LS12, LS21, and LS22 are large-signal S-parameters. You can plot these parameters as a function of input power or as a function of frequency.

Plot Type	Method	Parameter
Polar plane	polar	S11, S12, S21, S22 LS11, LS12, LS21, LS22 (Objects with data from a P2D file only)
Z Smith chart	smith with type argument set to 'z'	S11, S22 LS11, LS22 (Objects with data from a P2D file only)
Y Smith chart	smith with type argument set to 'y'	S11, S22 LS11, LS22 (Objects with data from a P2D file only)
ZY Smith chart	smith with type argument set to 'zy'	S11, S22 LS11, LS22 (Objects with data from a P2D file only)

By default, the toolbox plots the parameter as a function of frequency. When you import block data from a .p2d or .s2d file, you can also plot parameters as a function of any operating condition from the file that has numeric values, such as bias.

Note: The circle method lets you place circles on a Smith Chart to depict stability regions and display constant gain, noise figure, reflection and immittance circles. For

more information about this method, see the `circle` reference page or the two-part RF Toolbox example about designing matching networks.

For more information on a particular type of plot, follow the link in the table to the documentation for that method.

Compute and Plot Time-Domain Specifications

The toolbox lets you compute and plot time-domain characteristics for RF components.

This section contains the following topics:

- “Compute the Network Transfer Function” on page 3-32
- “Fit a Model Object to Circuit Object Data” on page 3-32
- “Compute and Plotting the Time-Domain Response” on page 3-33

Compute the Network Transfer Function

You use the `s2tf` function to convert 2-port S-parameters to a transfer function. The function returns a vector of transfer function values that represent the normalized voltage gain of a 2-port network.

The following code illustrates how to read file data into a passive circuit object, extract the 2-port S-parameters from the object and compute the transfer function of the data at the frequencies for which the data is specified. `z0` is the reference impedance of the S-parameters, `zs` is the source impedance, and `z1` is the load impedance. See the `s2tf` reference page for more information on how these impedances are used to define the gain.

```
PassiveCkt = rfckt.passive('File','passive.s2p')
z0=50; zs=50; z1=50;
[SParams, Freq] = extract(PassiveCkt, 'S Parameters', z0);
TransFunc = s2tf(SParams, z0, zs, z1);
```

Fit a Model Object to Circuit Object Data

You use the `rationalfit` function to fit a rational function to the transfer function of a passive component. The `rationalfit` function returns an `rfmodel` object that represents the transfer function analytically.

The following code illustrates how to use the `rationalfit` function to create an `rfmodel.rational` object that contains a rational function model of the transfer function that you created in the previous example.

```
RationalFunc = rationalfit(Freq, TransFunc)
```

To find out how many poles the toolbox used to represent the data, look at the length of the `A` vector of the `RationalFunc` model object.

```
nPoles = length(RationalFunc.A)
```

Note: The number of poles is important if you plan to use the RF model object to create a model for use in another simulator, because a large number of poles can increase simulation time. For information on how to represent a component accurately using a minimum number of poles, see “Represent a Circuit Object with a Model Object” on page 4-4.

See the `rationalfit` reference page for more information.

Use the `freqresp` method to compute the frequency response of the fitted data. To validate the model fit, plot the transfer function of the original data and the frequency response of the fitted data.

```
Resp = freqresp(RationalFunc, Freq);
plot(Freq, 20*log10(abs(TransFunc)), 'r', ...
     Freq, 20*log10(abs(Resp)), 'b--');
ylabel('Magnitude of H(s) (decibels)');
xlabel('Frequency (Hz)');
legend('Original', 'Fitting result');
title(['Rational fitting with ', int2str(nPoles), ' poles']);
```

Compute and Plotting the Time-Domain Response

You use the `timeresp` method to compute the time-domain response of the transfer function that `RationalFunc` represents.

The following code illustrates how to create a random input signal, compute the time-domain response of `RationalFunc` to the input signal, and plot the results.

```
SampleTime=1e-11;
NumberOfSamples=4750;
OverSamplingFactor = 25;
```

```
InputTime = double((1:NumberOfSamples)')*SampleTime;
InputSignal = ...
    sign(randn(1, ceil(NumberOfSamples/OverSamplingFactor)));
InputSignal = repmat(InputSignal, [OverSamplingFactor, 1]);
InputSignal = InputSignal(:);

[tresp,t]=timeresp(RationalFunc,InputSignal,SampleTime);
plot(t*1e9,tresp);
title('Fitting Time-Domain Response', 'fonts', 12);
ylabel('Response to Random Input Signal');
xlabel('Time (ns)');
```

For more information about computing the time response of a model object, see the `timeresp` reference page.

Export Component Data to a File

In this section...

“Available Export Formats” on page 3-35

“How to Export Object Data” on page 3-35

“Export Object Data” on page 3-36

Available Export Formats

RF Toolbox software lets you export data from any `rfckt` object or from an `rfdata.data` object to industry-standard data files and MathWorks AMP files. This export capability lets you store data for use in other simulations.

Note: The toolbox also lets you export data from an `rfmodel` object to a Verilog-A file. For information on how to do this, see “Export a Verilog-A Model” on page 4-4.

You can export data to the following file formats:

- Industry-standard file formats — Touchstone SNP, YNP, ZNP, HNP, and GNP formats specify the network parameters and noise information for measured and simulated data.

For more information about Touchstone files, see www.vhdl.org/pub/ibis/connector/touchstone_spec11.pdf.

- MathWorks amplifier (AMP) file format — Specifies amplifier network parameters, output power versus input power, noise data and third-order intercept point.

For more information about `.amp` files, see “AMP File Data Sections” on page 9-2.

How to Export Object Data

To export data from a circuit or data object, use a `write` command of the form

```
status = write(obj, 'filename');
```

where

- `status` is a return value that indicates whether the write operation was successful.
- `obj` is the handle of the circuit or `rfdata.data` object.
- `filename` is the name of the file that contains the data.

For example,

```
status = write(rfckt.amplifier, 'myamp.amp');
```

exports data from an `rfckt.amplifier` object to the file `myamp.amp`.

Export Object Data

In this example, use the toolbox to create a vector of S-parameter data, store it in an `rfdata.data` object, and export it to a Touchstone file.

At the MATLAB prompt:

- 1 Type the following to create a vector, `s_vec`, of S-parameter values at three frequency values:

```
s_vec(:,:,1) = ...  
    [-0.724725-0.481324i, -0.685727+1.782660i; ...  
     0.000000+0.000000i, -0.074122-0.321568i];  
s_vec(:,:,2) = ...  
    [-0.731774-0.471453i, -0.655990+1.798041i; ...  
     0.001399+0.000463i, -0.076091-0.319025i];  
s_vec(:,:,3) = ...  
    [-0.738760-0.461585i, -0.626185+1.813092i; ...  
     0.002733+0.000887i, -0.077999-0.316488i];
```

- 2 Type the following to create an `rfdata.data` object called `txdata` with the default property values:

```
txdata = rfdata.data;
```

- 3 Type the following to set the S-parameter values of `txdata` to the values you specified in `s_vec`:

```
txdata.S_Parameters = s_vec;
```

- 4 Type the following to set the frequency values of `txdata` to `[1e9 2e9 3e9]`:

```
txdata.Freq=1e9*[1 2 3];
```

- 5 Type the following to export the data in `txdata` to a Touchstone file called `test.s2p`:

```
write(txdata, 'test')
```

Basic Operations with RF Objects

In this section...

“Read and Analyze RF Data from a Touchstone Data File” on page 3-38

“De-Embed S-Parameters” on page 3-40

Read and Analyze RF Data from a Touchstone Data File

In this example, you create an `rfdata.data` object by reading the S-parameters of a 2-port passive network stored in the Touchstone format data file, `passive.s2p`.

- 1 Read S-parameter data from a data file.** Use the RF Toolbox `read` command to read the Touchstone data file, `passive.s2p`. This file contains 50-ohm S-parameters at frequencies ranging from 315 kHz to 6 GHz. The `read` command creates an `rfdata.data` object, `data`, and stores data from the file in the object's properties.

```
data = read(rfdata.data, 'passive.s2p');
```

- 2 Extract the network parameters from the data object.** Use the `extract` command to convert the 50-ohm S-parameters in the `rfdata.data` object, `data`, to 75-ohm S-parameters and save them in the variable `s_params`. You also use the command to extract the Y-parameters from the `rfdata.data` object and save them in the variable `y_params`.

```
freq = data.Freq;  
s_params = extract(data, 'S_PARAMETERS', 75);  
y_params = extract(data, 'Y_PARAMETERS');
```

- 3 Plot the S_{11} parameters.** Use the `smithchart` command to plot the 75-ohm S_{11} parameters on a Smith Chart:

```
s11 = s_params(1,1,:);  
smithchart(s11(:));
```

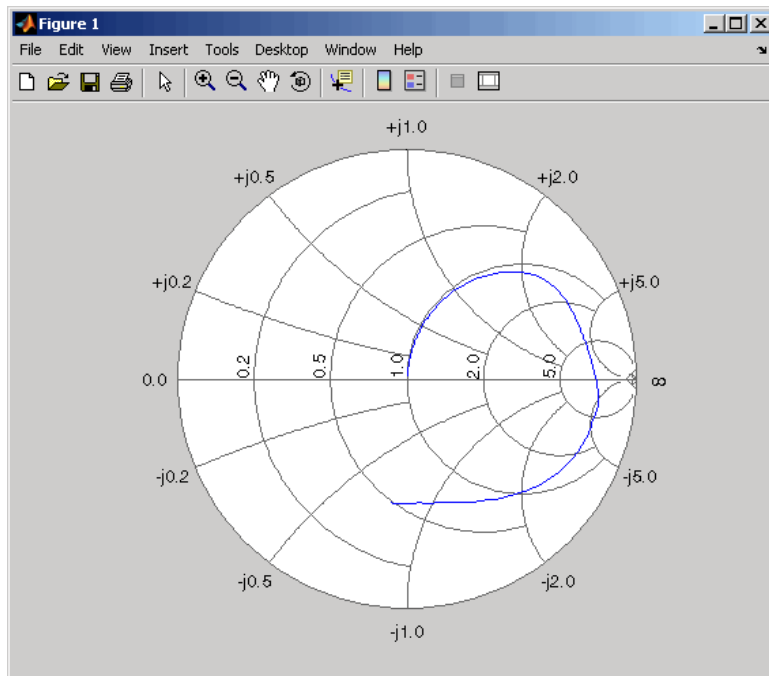

- 4 View the 75-ohm S-parameters and Y-parameters at 6 GHz.** Type the following set of commands at the MATLAB prompt to display the four 75-ohm S-parameter values and the four Y-parameter values at 6 GHz.

```
f = freq(end)
s = s_params(:, :, end)
y = y_params(:, :, end)
```

The toolbox displays the following output:

```
f =
  6.0000e+009

s =
 -0.0764 - 0.5401i   0.6087 - 0.3018i
  0.6094 - 0.3020i  -0.1211 - 0.5223i

y =
  0.0210 + 0.0252i  -0.0215 - 0.0184i
```

```
-0.0215 - 0.0185i    0.0224 + 0.0266i
```

For more information, see the `rfdata.data`, `read`, and `extract` reference pages.

De-Embed S-Parameters

The Touchstone data file `samplebjt2.s2p` contains S-parameter data collected from a bipolar transistor in a test fixture. The input of the fixture has a bond wire connected to a bond pad. The output of the fixture has a bond pad connected to a bond wire.

The configuration of the bipolar transistor, which is the device under test (DUT), and the fixture is shown in the following figure.

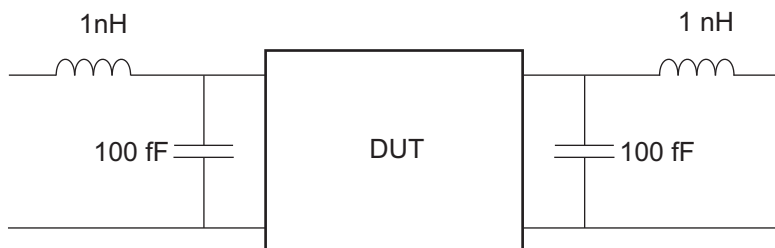

In this example, you remove the effects of the fixture and extract the S-parameters of the DUT.

- 1 Create RF objects.** Create a data object for the measured S-parameters by reading the Touchstone data file `samplebjt2.s2p`. Then, create two more circuit objects, one each for the input pad and output pad.

```
measured_data = read(rfdata.data, 'samplebjt2.s2p');
input_pad = rfckt.cascade('Ckts', ...
    {rfckt.seriesrlc('L', 1e-9), ...
    rfckt.shuntrlc('C', 100e-15)}); % L=1 nH, C=100 fF
output_pad = rfckt.cascade('Ckts', ...
    {rfckt.shuntrlc('C', 100e-15), ...
    rfckt.seriesrlc('L', 1e-9)}); % L=1 nH, C=100 fF
```

- 2 Analyze the input pad and output pad circuit objects.** Analyze the circuit objects at the frequencies at which the S-parameters are measured.

```
freq = measured_data.Freq;
```



```
analyze(input_pad,freq);
analyze(output_pad,freq);
```

- 3 De-embed the S-parameters.** Extract the S-parameters of the DUT from the measured S-parameters by removing the effects of the input and output pads.

```
z0 = measured_data.Z0;
```

```
input_pad_sparams = extract(input_pad.AnalyzedResult,...
'S_Parameters',z0);
output_pad_sparams = extract(output_pad.AnalyzedResult,...
'S_Parameters',z0);
```

```
de_embedded_sparams = ...
deembedsparams(measured_data.S_Parameters,...
input_pad_sparams, output_pad_sparams);
```

- 4 Create a data object for the de-embedded S-parameters.** In a later step, you use this data object to plot the de-embedded S-parameters.

```
de_embedded_data = rfdata.data('Z0',z0,...
'S_Parameters',de_embedded_sparams,...
'Freq',freq);
```

- 5 Plot the measured and de-embedded S_{11} parameters.** Type the following set of commands at the MATLAB prompt to plot both the measured and the de-embedded S_{11} parameters on a Z Smith Chart:

```
hold off;
h = smith(measured_data,'S11');
set(h, 'Color', [1 0 0]);
hold on
i = smith(de_embedded_data,'S11');
set(i, 'Color', [0 0 1], 'LineStyle', ':');
l = legend;
legend('Measured S_{11}', 'De-embedded S_{11}');
legend show;
```

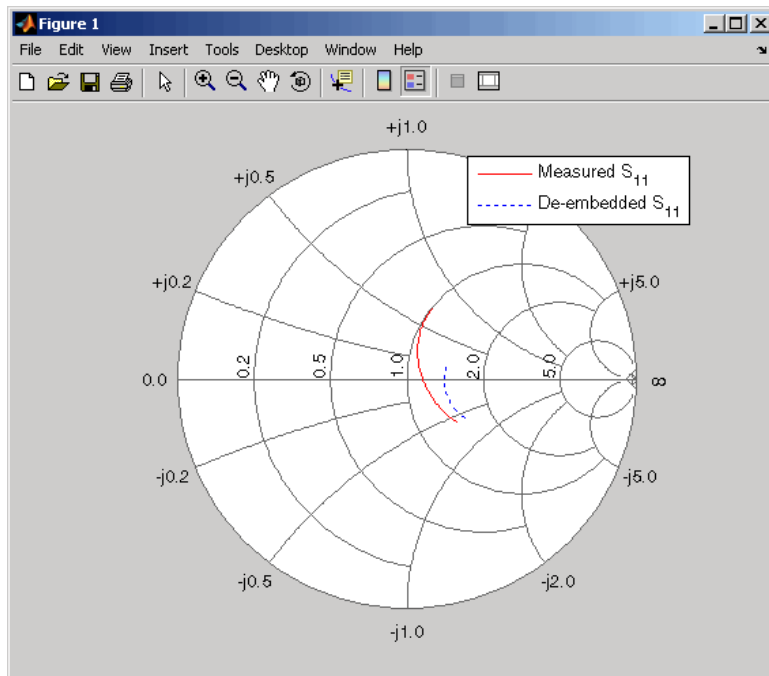

- 6 Plot the measured and de-embedded S_{22} parameters.** Type the following set of commands at the MATLAB prompt to plot the measured and the de-embedded S_{22} parameters on a Z Smith Chart:

```
figure;
hold off;
h = smith(measured_data,'S22');
set(h, 'Color', [1 0 0]);
hold on
i = smith(de_embedded_data,'S22');
set(i, 'Color', [0 0 1], 'LineStyle', ':');
l = legend;
legend('Measured S_{22}', 'De-embedded S_{22}');
legend show;
```

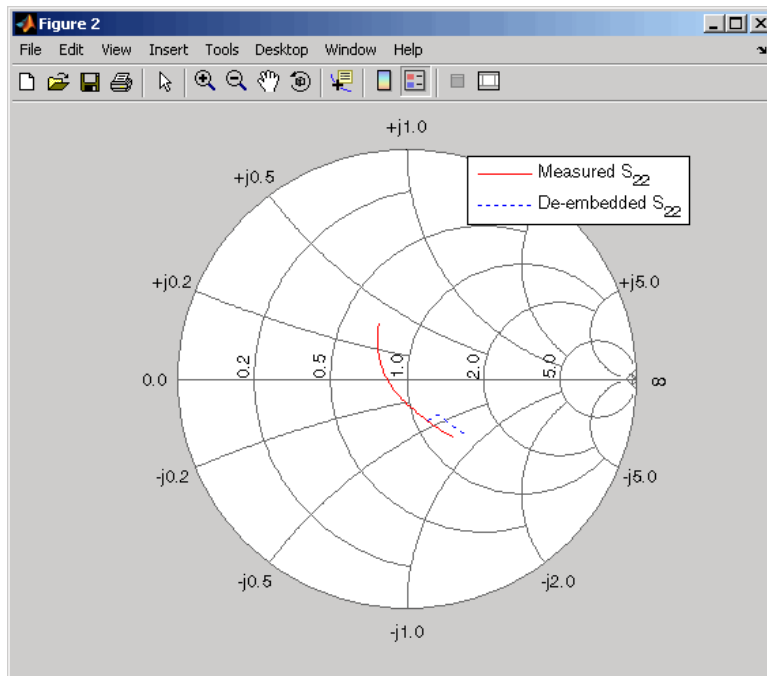

- 7 Plot the measured and de-embedded S_{21} parameters.** Type the following set of commands at the MATLAB prompt to plot the measured and the de-embedded S_{21} parameters, in decibels, on an X-Y plane:

```
figure
hold off;
h = plot(measured_data,'S21', 'db');
set(h, 'Color', [1 0 0]);
hold on
i = plot(de_embedded_data,'S21','db');
set(i, 'Color', [0 0 1], 'LineStyle', ':');
l = legend;
legend('Measured S_{21}', 'De-embedded S_{21}');
legend show;
hold off;
```

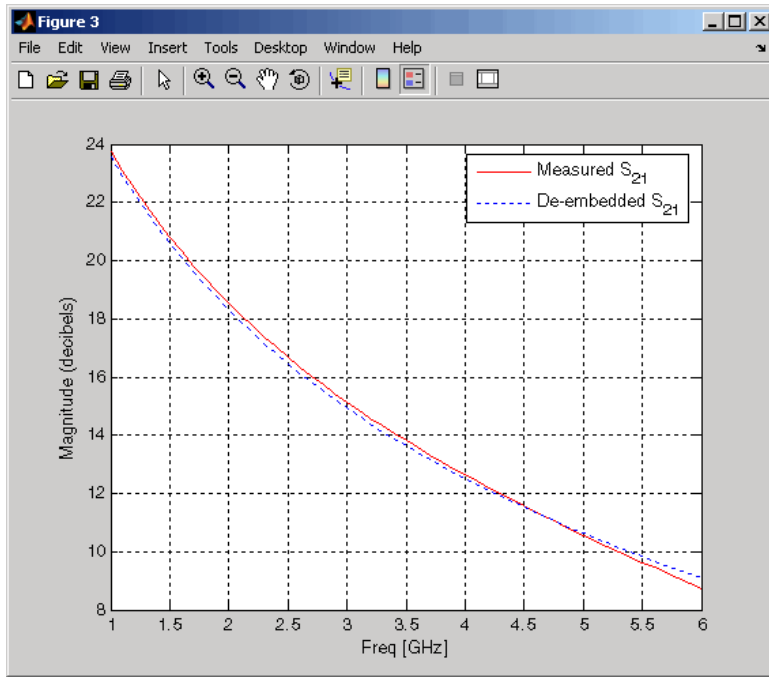

Export Verilog-A Models

- “Model RF Objects Using Verilog-A” on page 4-2
- “Export a Verilog-A Model” on page 4-4

Model RF Objects Using Verilog-A

In this section...
“Overview” on page 4-2
“Behavioral Modeling Using Verilog-A” on page 4-2
“Supported Verilog-A Models” on page 4-3

Overview

Verilog-A is a language for modeling the high-level behavior of analog components and networks. Verilog-A describes components mathematically, for fast and accurate simulation.

RF Toolbox software lets you export a Verilog-A description of your circuit. You can create a Verilog-A model of any passive RF component or network and use it as a behavioral model for transient analysis in a third-party circuit simulator. This capability is useful in signal integrity engineering. For example, you can import the measured four-port S-parameters of a backplane into the toolbox, export a Verilog-A model of the backplane to a circuit simulator, and use the model to determine the performance of your driver and receiver circuitry when they are communicating across the backplane.

Behavioral Modeling Using Verilog-A

The Verilog-A language is a high-level language that uses modules to describe the structure and behavior of analog systems and their components. A *module* is a programming building block that forms an executable specification of the system.

Verilog-A uses modules to capture high-level analog behavior of components and systems. Modules describe circuit behavior in terms of

- Input and output nets characterized by predefined Verilog-A disciplines that describe the attributes of the nets.
- Equations and module parameters that define the relationship between the input and output nets mathematically.

When you create a Verilog-A model of your circuit, the toolbox writes a Verilog-A module that specifies circuit's input and output nets and the mathematical equations that describe how the circuit operates on the input to produce the output.

For more information on the Verilog-A language, see the Verilog-A Reference Manual.

Supported Verilog-A Models

RF Toolbox software lets you export a Verilog-A model of an `rfmodel` object. The toolbox provides one `rfmodel` object, `rfmodel.rational`, that you can use to represent any RF component or network for export to Verilog-A.

The `rfmodel.rational` object represents components as rational functions in pole-residue form, as described in the `rfmodel.rational` reference page. This representation can include complex poles and residues, which occur in complex-conjugate pairs.

The toolbox implements each `rfmodel.rational` object as a series of Laplace Transform S-domain filters in Verilog-A using the numerator-denominator form of the Laplace transform filter:

$$H(s) = \frac{\sum_{k=0}^M n_k s^k}{\sum_{k=0}^N d_k s^k}$$

where

- M is the order of the numerator polynomial.
- N is the order of the denominator polynomial.
- n_k is the coefficient of the k th power of s in the numerator.
- d_k is the coefficient of the k th power of s in the denominator.

The number of poles in the rational function is related to the number of Laplace transform filters in the Verilog-A module. However, there is not a one-to-one correspondence between the two. The difference arises because the toolbox combines each pair of complex-conjugate poles and the corresponding residues in the rational function to form a Laplace transform numerator and denominator with real coefficients. the toolbox converts the real poles of the rational function directly to a Laplace transform filter in numerator-denominator form.

Export a Verilog-A Model

In this section...

“Represent a Circuit Object with a Model Object” on page 4-4

“Write a Verilog-A Module” on page 4-5

Represent a Circuit Object with a Model Object

Before you can write a Verilog-A model of an RF circuit object, you need to create an `rfmodel.rational` object to represent the component.

There are two ways to create an RF model object:

- You can fit a rational function model to the component data using the `rationalfit` function.
- You can use the `rfmodel.rational` constructor to specify the pole-residue representation of the component directly.

This section discusses using a rational function model. For more information on using the constructor, see the `rfmodel.rational` reference page.

When you use the `rationalfit` function to create an `rfmodel.rational` object that represents an RF component, the arguments you specify affect how quickly the resulting Verilog-A model runs in a circuit simulator.

You can use the `rationalfit` function with only the two required arguments. The syntax is:

```
model_obj = rationalfit(freq,data)
```

where

- `model_obj` is a handle to the rational function model object.
- `freq` is a vector of frequency values that correspond to the data values.
- `data` is a vector that contains the data to fit.

For faster simulation, create a model object with the smallest number of poles required to accurately represent the component. To control the number of poles, use the syntax:

```
model_obj = rationalfit(freq,data,tol,weight,delayfactor)
```

where

- *tol* — the relative error-fitting tolerance, in decibels. Specify the largest acceptable tolerance for your application. Using tighter tolerance values may force the `rationalfit` function to add more poles to the model to achieve a better fit.
- *weight* — a vector that specifies the weighting of the fit at each frequency.
- *delayfactor* — a value that controls the amount of delay used to fit the data. Delay introduces a phase shift in the frequency domain that may require a large number of poles to fit using a rational function model. When you specify the delay factor, the `rationalfit` function represents the delay as an exponential phase shift. This phase shift allows the function to fit the data using fewer poles.

These arguments are described in detail in the `rationalfit` function reference page.

Note: You can also specify the number of poles directly using the `npoles` argument. The model accuracy is not guaranteed with approach, so you should not specify `npoles` when accuracy is critical. For more information on the `npoles` argument, see the `rationalfit` reference page.

If you plan to integrate the Verilog-A module into a large design for simulation using detailed models, such as transistor-level circuit models, the simulation time consumed by a Verilog-A module may have a trivial impact on the overall simulation time. In this case, there is no reason to take the time to optimize the rational function model of the component.

For more information on the `rationalfit` function arguments, see the `rationalfit` reference page.

Write a Verilog-A Module

You use the `writева` method to create a Verilog-A module that describes the RF model object. This method writes the module to a specified file. Use the syntax:

```
status = writева(model_obj, 'obj1', {'inp', 'inn'}, {'outp', 'outn'})
```

to write a Verilog-A module for the model object `model_obj` to the file `obj1.va`. The module has differential input nets, *inp* and *inn*, and differential output nets, *outp* and

outn. The method returns `status`, a logical value of `true` if the operation is successful and `false` otherwise.

The `writeva` reference page describes the method arguments in detail.

An example of exporting a Verilog-A module appears in the RF Toolbox example, Modeling a High-Speed Backplane (Part 5: Rational Function Model to a Verilog-A Module).

The RF Design and Analysis App

- “The RF Design and Analysis App” on page 5-2
- “Create and Import Circuits ” on page 5-6
- “Modify Component Data ” on page 5-20
- “Analyze Circuits” on page 5-21
- “Export RF Objects ” on page 5-24
- “Manage Circuits and Sessions” on page 5-29
- “Model an RF Network ” on page 5-33

The RF Design and Analysis App

In this section...

“What Is the RF Design and Analysis App?” on page 5-2

“Open the RF Design and Analysis App” on page 5-2

“The RF Design and Analysis Window ” on page 5-3
--

“The RF Design and Analysis App Workflow” on page 5-4

What Is the RF Design and Analysis App?

The RF Design and Analysis is an app that provides a visual interface for creating and analyzing RF components and networks. You can use the RF Design and Analysis app as a convenient alternative to the command-line RF circuit design and analysis objects and methods that come with RF Toolbox software.

The RF Design and Analysis app provides the ability to

- Create and import circuits.
- Set circuit parameters.
- Analyze circuits.
- Display circuit S-parameters in tabular form and on X-Y plots, polar plots, and Smith Charts.
- Export circuit data to the MATLAB workspace and to data files.

Open the RF Design and Analysis App

To open the app window, type the following at the MATLAB prompt:

```
rftool
```

For a description of the RF Design and Analysis user interface , see “The RF Design and Analysis Window ” on page 5-3. To learn how to create and import circuits, see “Create and Import Circuits ” on page 5-6.

Note: The work you do with this app is organized into sessions. Each session is a collection of independent RF circuits, which can be RF components or RF networks. You

can save sessions and then load them for later use. For more information, see “Working with the RF Design and Analysis App Sessions” on page 5-30.

The RF Design and Analysis Window

The app window consists of the following three panes:

- **RF Component List**

Shows the components and networks in the session. The top-level node is the session.

- **Component Parameters**

Displays options and settings pertaining to the node you selected in the **RF Component List** pane.

- **Analysis**

Displays options and settings pertaining to the circuit analysis and results display. After you analyze the circuit, this pane displays the analysis results and provides an interface for you to view the S-parameter data and modify the displayed plots.

The following figure shows the app window.

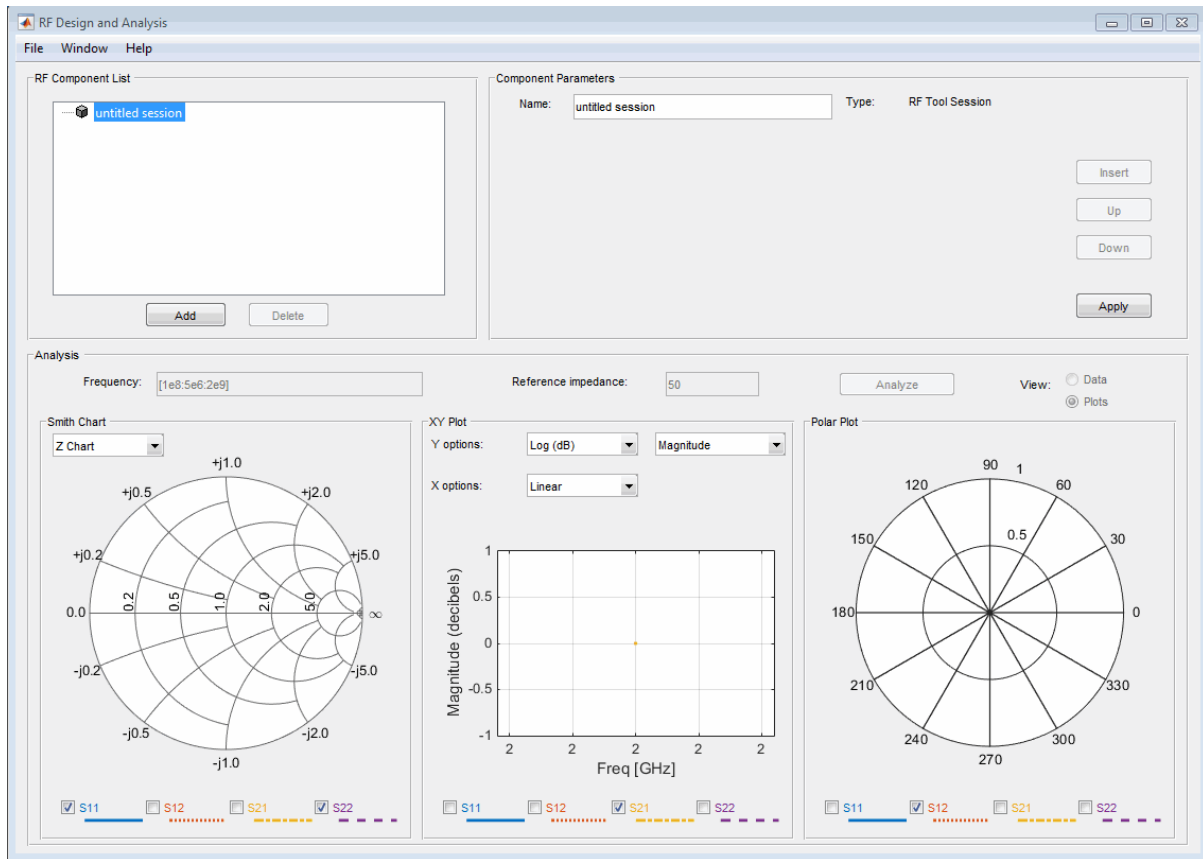

The RF Design and Analysis App Workflow

When you analyze a circuit using the app user interface your workflow might include the following tasks:

- 1 Build the circuit by
 - Creating RF components and networks.
 - Importing components and networks from the MATLAB workspace or from a data file.

See “Create and Import Circuits ” on page 5-6.

- 2** Specify component data.
See “Modify Component Data ” on page 5-20.
- 3** Analyze the circuit.
See “Analyze Circuits” on page 5-21.
- 4** Export the circuit to the MATLAB workspace or to a file.
See “Export RF Objects ” on page 5-24.

Create and Import Circuits

In this section...

“Circuits in the RF Design and Analysis App” on page 5-6

“Create RF Components” on page 5-6

“Create RF Networks ” on page 5-10

“Import RF Objects into the RF Design and Analysis App” on page 5-16

Circuits in the RF Design and Analysis App

In this app, you can create circuits that include RF components and RF networks. Networks can contain both components and other networks.

Note: In the circuit object command line interface, you create networks by building components and then connecting them together to form a network. In contrast, you build networks in the app by creating a network and then populating it with components.

Create RF Components

This section contains the following topics:

- “Available RF Components” on page 5-6
- “Add an RF Component to a Session” on page 5-7

Available RF Components

The following table lists the RF components you can create using the app and the corresponding RF Toolbox object.

RF Component	Corresponding RF Object
Data File	rfckt.datafile
Delay Line	rfckt.delay
Coaxial Transmission Line	rfckt.coaxial

RF Component	Corresponding RF Object
Coplanar Waveguide Transmission Line	rfckt.cpw
Microstrip Transmission Line	rfckt.microstrip
Parallel-Plate Transmission Line	rfckt.parallelplate
Transmission Line	rfckt.txline
Two-Wire Transmission Line	rfckt.twowire
Series RLC	rfckt.seriesrlc
Shunt RLC	rfckt.shuntrlc
LC Bandpass Pi	rfckt.lcbandpasspi
LC Bandpass Tee	rfckt.lcbandpasstee
LC Bandstop Pi	rfckt.lcbandstoppi
LC Bandstop Tee	rfckt.lcbandstoptee
LC Highpass Pi	rfckt.lchighpasspi
LC Highpass Tee	rfckt.lchighpasstee
LC Lowpass Pi	rfckt.lclowpasspi
LC Lowpass Tee	rfckt.lclowpasstee

Add an RF Component to a Session

- 1 In the **RF Component List** pane, click **Add** to open the Create Network or Component dialog box.

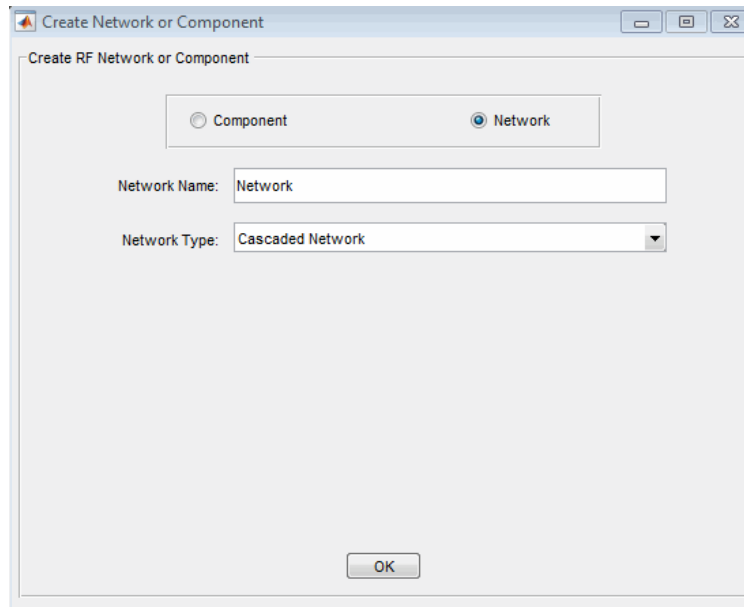

- 2 In the Create Network or Component dialog box, select **Component**.
- 3 In the **Component Name** field, enter a name for the component. This name is used to identify the component in the **RF Component List** pane. For example, Microstrip Component.
- 4 From the **Component Type** menu, select the type of RF component you want to create. For example, Microstrip Transmission Line.

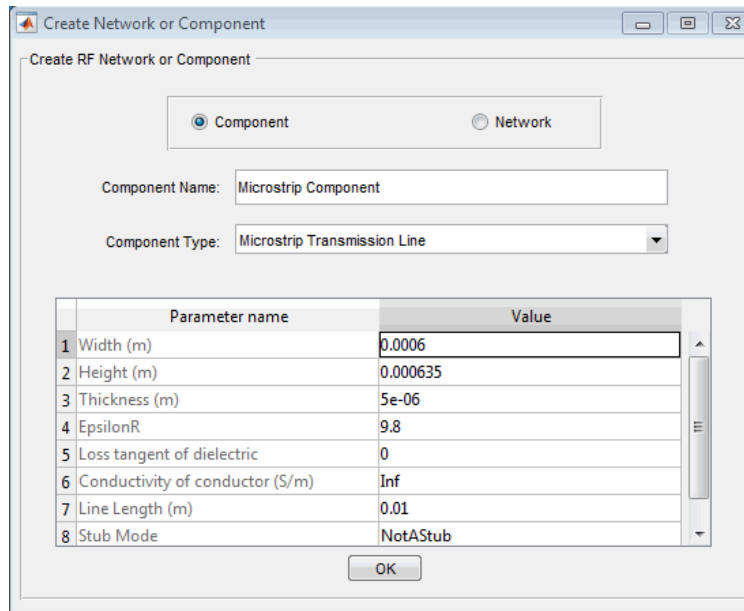

- 5 Adjust the parameter values as necessary.

Note: You can accept the default values for some or all of the parameters and then change them later. For information on modifying the parameter values of an existing component, see “Modify Component Data ” on page 5-20.

- 6 Click **OK**.

The app adds the component to your session.

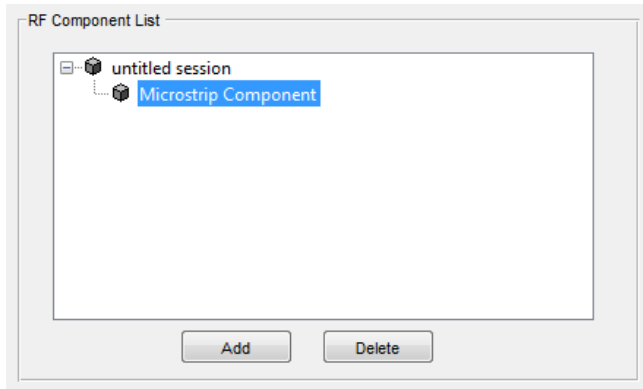

Create RF Networks

You create an RF network using the app by adding a network to the session and then adding components to the network.

This section contains the following topics:

- “Available RF Networks” on page 5-10
- “Add an RF Network to a Session” on page 5-11
- “Populate an RF Network” on page 5-13
- “Reorder Circuits Within a Network” on page 5-15

Available RF Networks

The following table lists the RF networks you can create using the app.

RF Network	Corresponding RF Toolbox Object
Cascaded Network	<code>rfckt.cascade</code>
Series Connected Network	<code>rfckt.series</code>
Parallel Connected Network	<code>rfckt.parallel</code>
Hybrid Connected Network	<code>rfckt.hybrid</code>
Inverse Hybrid Connected Network	<code>rfckt.hybridg</code>

Add an RF Network to a Session

- 1 In the **RF Component List** pane, click **Add** to open the Create Network or Component dialog box.

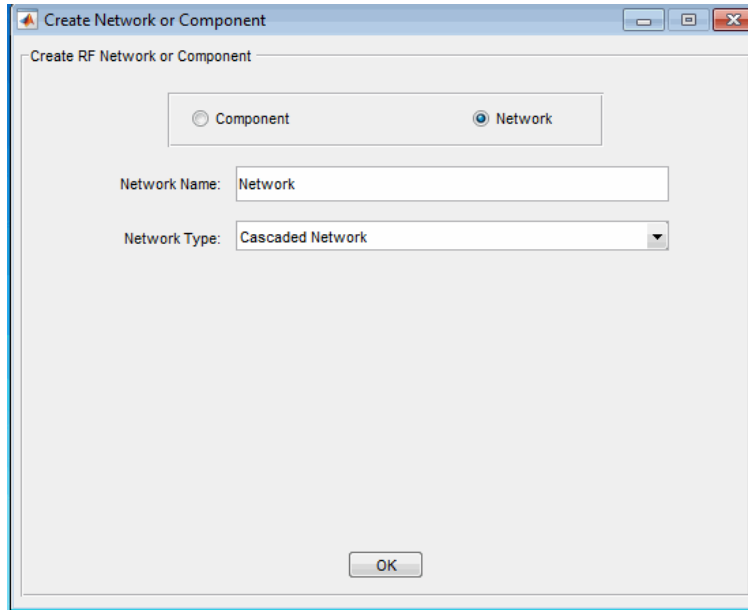

- 2 In the Create Network or Component dialog box, select the **Network** option button.
- 3 In the **Network Name** field, enter a name for the component. This name is used to identify the network in the **RF Component List** pane. For example, Series1.
- 4 From the **Network Type** menu, select the type of RF network you want to create. For example, Series Connected Network.

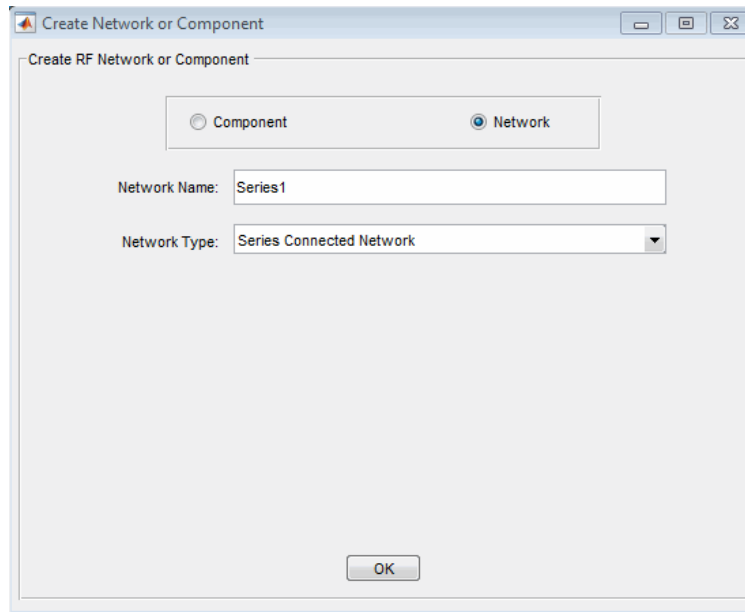

5 Click **OK**.

The RF Component List pane shows the new network.

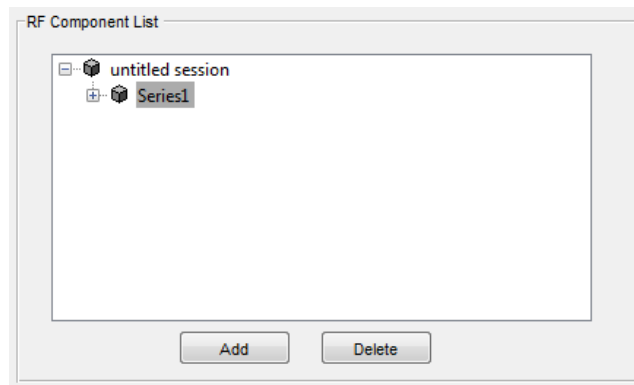

Populate an RF Network

After you create a network using the app, you must populate it with RF components and networks. You insert a component or network into a network in much the same way you add one to a session.

To populate an RF network:

- 1 In the **RF Component List** pane, select the network component you want to modify. Then, in the **Component Parameters** pane, click **Insert**.

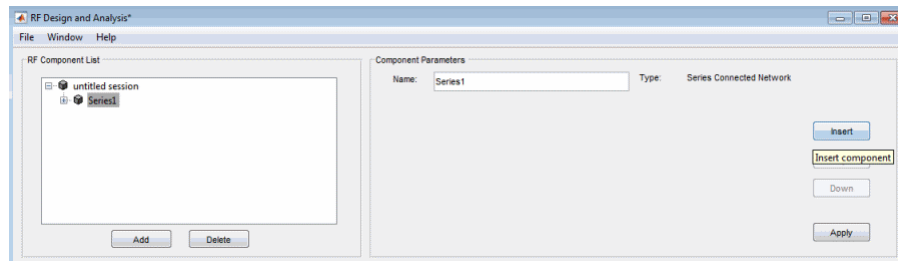

The Insert Component or Network dialog box appears.

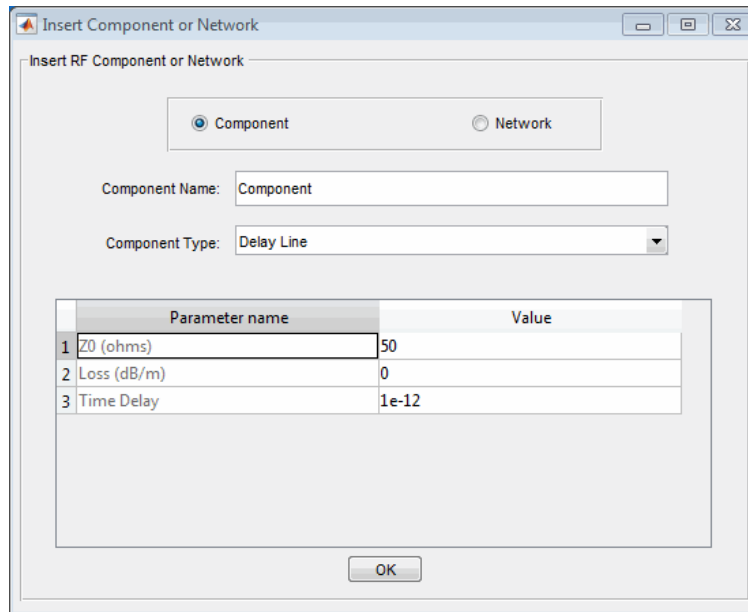

- 2 Click **Component** or **Network** in the Insert Component or Network dialog box to add either a component or a network.

Enter the component or network name, and select the appropriate type. If you are inserting a component, modify the parameter values as necessary. See “Add an RF Component to a Session” on page 5-7 or “Add an RF Network to a Session” on page 5-11 for details.

As you insert components and networks into a network, they are reflected in the **RF Component List** and **Component Parameters** panes. The figure below shows an example of a cascaded network that contains two components and a network. The subnetwork, in turn, contains two components.

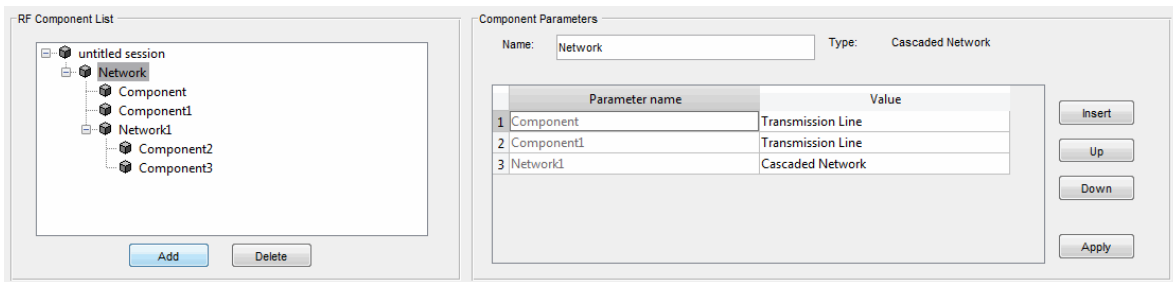

Reorder Circuits Within a Network

To change the order of the components and networks within a network:

- 1 In the **RF Component List** pane, select the network whose circuits you want to reorder.
- 2 In the **Component Parameters** pane, select the circuit whose position you want to change.
- 3 Click **Up** or **Down** until the circuit is where you want it.

To reverse the positions of **Component1** and **Network1** in the network shown in the following figure:

- 1 Select **Network** in the **RF Component List** pane.
- 2 Select **Component1** in the **Component Parameters** pane.
- 3 Click **Down** in the **Component Parameters** pane.

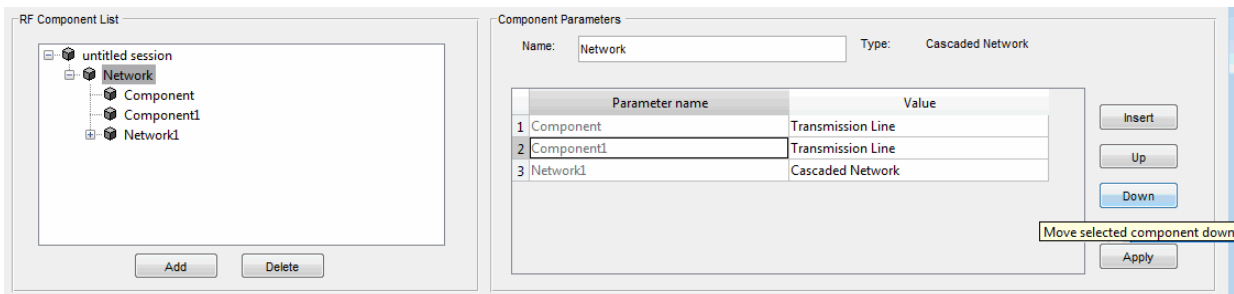

Import RF Objects into the RF Design and Analysis App

The RF Design and Analysis app lets you import RF objects from your workspace and from files to the top level of your session. You can import the following types of objects:

- Complex component and network objects that you created in your workspace using RF Toolbox objects.
- Components and networks you exported into your workspace from another session.

For information on exporting components and networks from another session, see “Export RF Objects ” on page 5-24.

After you have imported an object, you can change its name and work with it as you would any other component or network.

This section contains the following topics:

- “Import from the Workspace” on page 5-16
- “Import from a File into a Session” on page 5-17
- “Import from a File into a Network” on page 5-18

Import from the Workspace

To import RF circuit objects from the MATLAB workspace into your session:

- 1 Select **Import From Workspace** from the **File** menu. The Import from Workspace dialog box appears. This dialog box lists the handles of all RF circuit (`rfckt`) objects in the workspace.

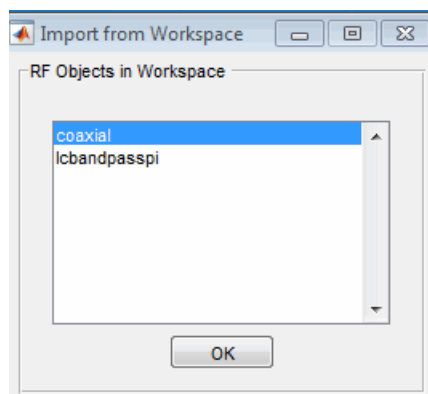

- From the list of RF circuit objects, select the object you want to import, and click **OK**.

The object is added to your session with the same name as the object handle. If there is already a circuit by that name, the app appends a numeral, starting with 1, to the new circuit name.

Import from a File into a Session

You can import RF components from the following types of files into the top level of your session:

- S2P
- Y2P
- Z2P
- H2P

To import a component from one of these files:

- Select **Import From File** from the **File** menu. A file browser appears.
- Select the file type you want to import.
- Select the name of the file to import from the list of files in the browser.

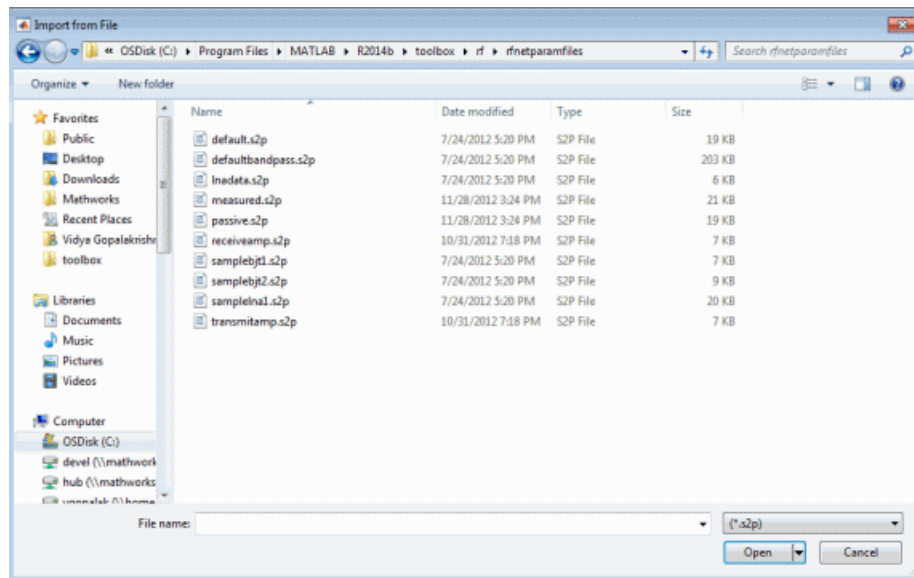

- 4 Click **Open** to add the object to your session as a component.

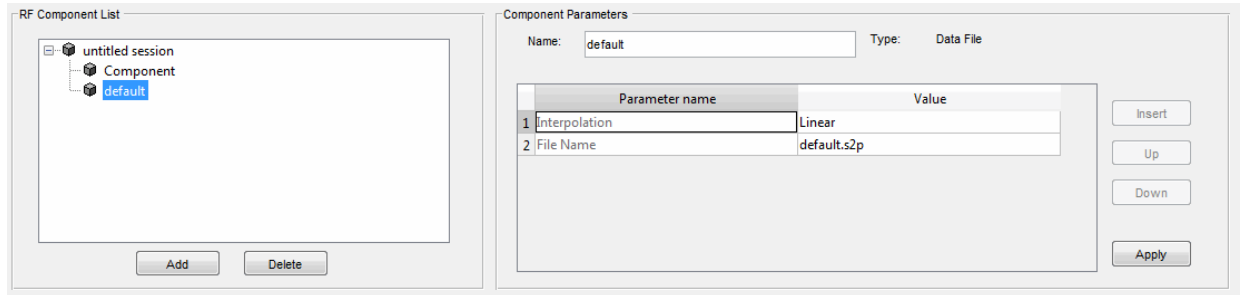

The name of the component is the file name without the extension. If there is already a component by that name, the app appends a numeral, starting with 1, to the new component name. The file name, including the extension, appears as the value of the component's **File Name** parameter. If the file is not on the MATLAB path, the value of the **File Name** parameter also contains the file path.

Import from a File into a Network

You can import RF components from the following types of files into a network:

- S2P
- Y2P
- Z2P
- H2P

To import an RF component from a file into a network:

- 1 Insert a Data File component into the network.

For more information on how add a component to a network, see “Populate an RF Network” on page 5-13.

- 2 Specify the name of the file from which to import the component in one of two ways:
 - Select the file name in the file name and type in the Import from File dialog box, and click **Open**.
 - Click **Cancel** to get out of the Import from File dialog box, and enter the file name in the **Value** field across from the **File Name** parameter in the Insert Component or Network dialog box.

“Model an RF Network ” on page 5-33 shows this process.

Modify Component Data

You can change the values of component parameters that you create and import. The component parameters in the app correspond to the component properties that you specify in the command line.

To modify these values:

- 1 Select the component in the **RF Component List** pane.
- 2 In the **Component Parameters** pane, select the value you want to change, and enter the new value.

Valid values for component parameters are listed on the corresponding RF Toolbox reference page. Use the links in “Available RF Components” on page 5-6 and “Available RF Networks” on page 5-10 to access these pages.

- 3 Click **Apply**.

Analyze Circuits

After you add your circuits, you can analyze them using the app:

- 1 Select the component or network you want to analyze in the **RF Component List** pane of the RF Design and Analysis app. For example, select the LC Bandpass Pi component, as shown in the following figure.

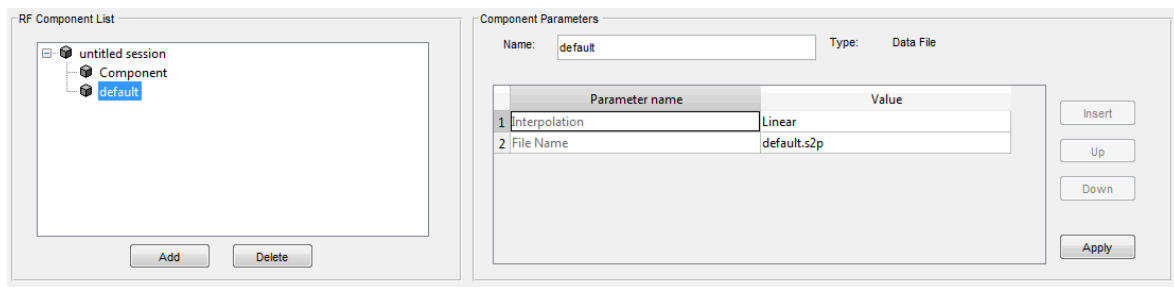

- 2 In the **Analysis** pane:

- Enter `[1e8:5e6:2e9]`, the analysis frequency range and step size in hertz, in the **Frequency** field.

This value specifies an analysis from 0.1 GHz to 2 GHz in 5 MHz steps.

- Enter `50`, the reference impedance in ohms, in the **Reference impedance** field.

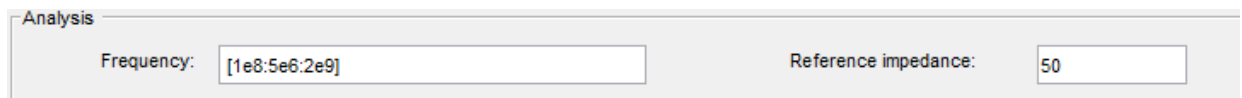

Note: Alternately, you can specify the **Frequency** and **Reference impedance** values as MATLAB workspace variables or as valid MATLAB expressions.

- 3 Click **Analyze**.

The **Analysis** pane displays a Smith Chart, an XY plot, and a polar plot of the analyzed circuit.

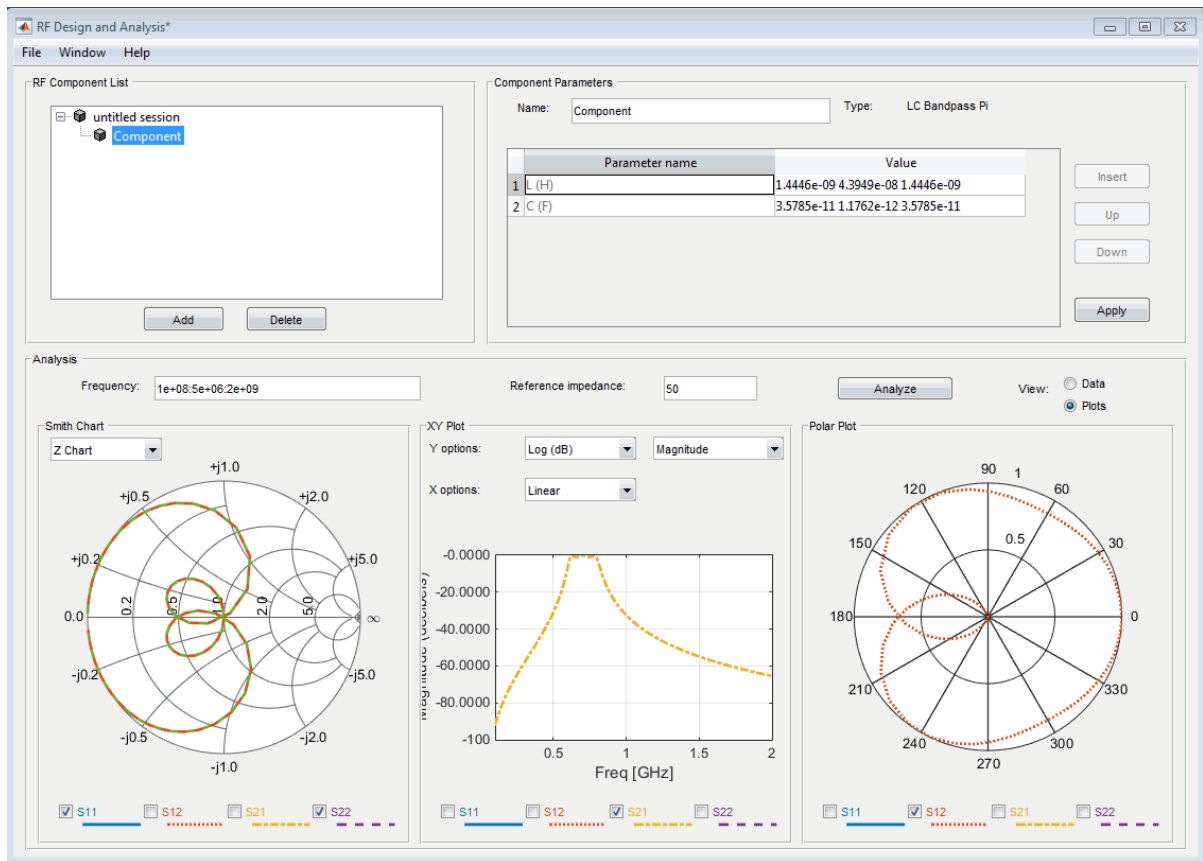

- 4 Select or deselect the S-parameter check boxes at the bottom of each plot to customize the parameters that the plot displays. Use the drop-down list at the top of each plot to customize the plot options.

The plots automatically update as you change the check box and drop-down list options on the user interface.

- 5 Click **Data** in the upper-right corner of the **Analysis** pane to view the data in tabular form. The following figure shows the analysis data for the LC Bandpass Pi component at the frequencies and reference impedance shown in step 2.

RF Design and Analysis*

File Window Help

RF Component List

untitled session
Component

Add Delete

Component Parameters

Name: Component Type: LC Bandpass PI

Parameter name	Value
1 L (H)	1.4446e-09 4.3949e-08 1.4446e-09
2 C (F)	3.5785e-11 1.1762e-12 3.5785e-11

Insert
Up
Down
Apply

Analysis

Frequency: 1e+08.5e+06.2e+09 Reference impedance: 50 Analyze View: Data Plots

Freq	20log10[S11]	<S11	20log10[S21]	<S21	20log10[S12]	<S12	20log10[S22]	<S22
1 1e+08	-0.000	+177.875	-91.722	-92.125	-91.722	-92.125	-0.000	+177.875
2 1.05e+08	-0.000	+177.764	-90.394	-92.236	-90.394	-92.236	-0.000	+177.764
3 1.1e+08	-0.000	+177.652	-89.122	-92.348	-89.122	-92.348	-0.000	+177.652
4 1.15e+08	-0.000	+177.539	-87.901	-92.461	-87.901	-92.461	-0.000	+177.539
5 1.2e+08	-0.000	+177.426	-86.727	-92.574	-86.727	-92.574	-0.000	+177.426
6 1.25e+08	-0.000	+177.312	-85.595	-92.688	-85.595	-92.688	-0.000	+177.312
7 1.3e+08	-0.000	+177.196	-84.501	-92.804	-84.501	-92.804	-0.000	+177.196
8 1.35e+08	-0.000	+177.080	-83.443	-92.920	-83.443	-92.920	-0.000	+177.080
9 1.4e+08	-0.000	+176.963	-82.418	-93.037	-82.418	-93.037	-0.000	+176.963
10 1.45e+08	-0.000	+176.844	-81.423	-93.156	-81.423	-93.156	-0.000	+176.844
11 1.5e+08	-0.000	+176.725	-80.456	-93.275	-80.456	-93.275	-0.000	+176.725
12 1.55e+08	-0.000	+176.604	-79.515	-93.396	-79.515	-93.396	-0.000	+176.604
13 1.6e+08	-0.000	+176.483	-78.598	-93.517	-78.598	-93.517	-0.000	+176.483
14 1.65e+08	-0.000	+176.359	-77.703	-93.641	-77.703	-93.641	-0.000	+176.359
15 1.7e+08	-0.000	+176.235	-76.829	-93.765	-76.829	-93.765	-0.000	+176.235
16 1.75e+08	-0.000	+176.109	-75.974	-93.891	-75.974	-93.891	-0.000	+176.109
17 1.8e+08	-0.000	+175.982	-75.137	-94.018	-75.137	-94.018	-0.000	+175.982

Note: The magnitude, in decibels, of S_{11} is listed in the 20log10[S11] column and the phase, in degrees, of S_{11} is listed in the <S11 column.

Export RF Objects

In this section...
“Export Components and Networks” on page 5-24
“Export to the Workspace” on page 5-24
“Export to a File” on page 5-26

Export Components and Networks

You can export RF components and networks that you create and refine it in the RF Design and Analysis app to your MATLAB workspace or to files. You export circuits for the following reasons:

- To perform additional analysis using RF Toolbox functions that are not available in the app.
- To incorporate them into larger RF systems.
- To import them into another session.

Export to the Workspace

The RF Design and Analysis app enables you to export components and networks to the MATLAB workspace. In your workspace, you can use the resulting circuit (`rfckt`) object as you would any other RF circuit object.

To export a component or network to the workspace:

- 1 Select the component or network to export in the **RF Component List** pane of the app.

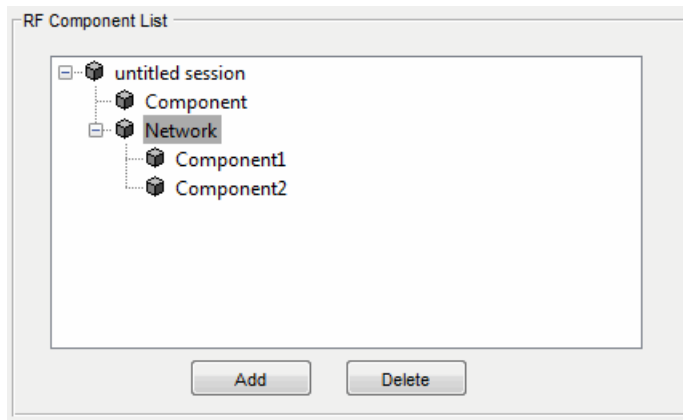

- 2 Select **Export to Workspace** from the **File** menu.
- 3 Enter a name for the exported object's handle in the **Variable name** field and click **OK**. The default name is the name of the component or network prefaced with the string 'rft_'.

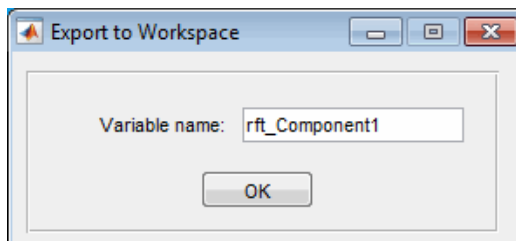

The component or network becomes accessible in the workspace via the specified object handle.

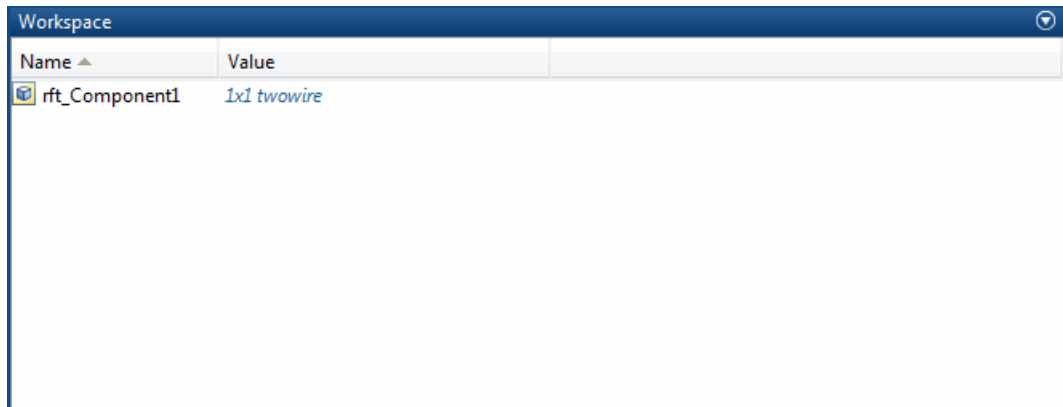

Export to a File

The RF Design and Analysis app lets you export components and networks to files in S2P format.

Note: You must analyze a component or network in the RF Design and Analysis app before you can export it to a file. See “Analyze Circuits” on page 5-21 for more information.

To export a component or network to a file:

- 1 Select the component or network to export in the **RF Component List** pane of the app.

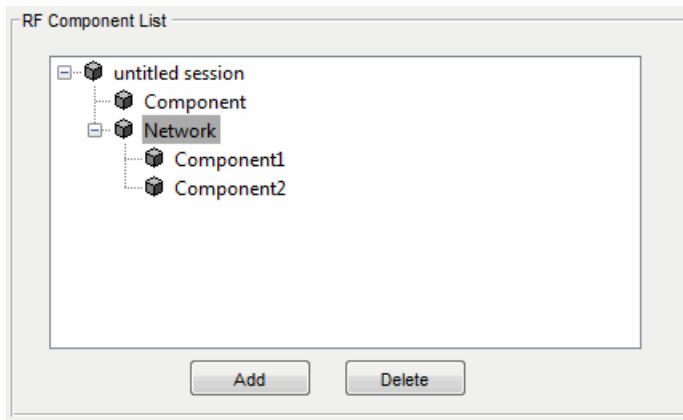

- 2 Select **Export To File** from the **File** menu to open the file browser.

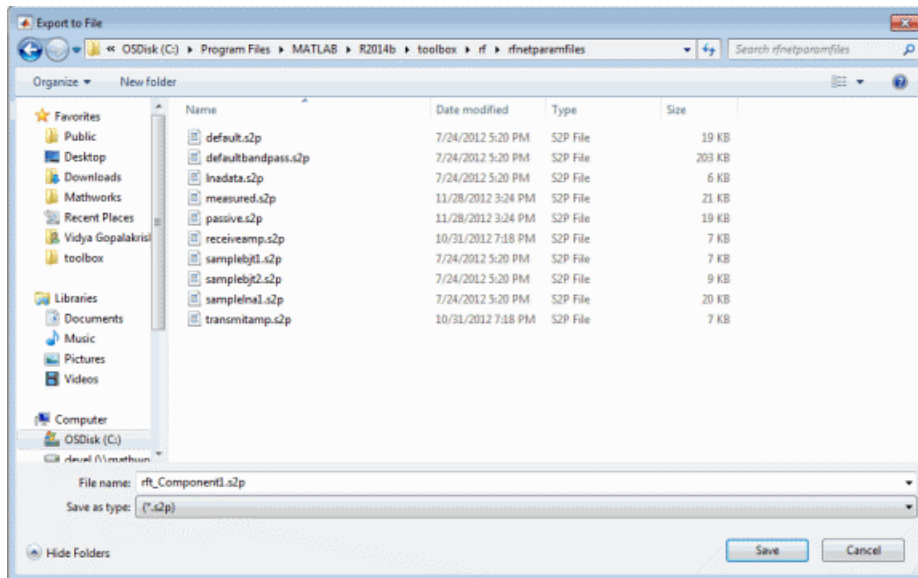

- 3 Browse to the appropriate directory. Enter the name you want to give the file and click **Save**.

The default file name is the current name of the component or network prefaced with the string 'rft_'. The app also converts any characters that are not alphanumeric to underscores ().

Manage Circuits and Sessions

In this section...

“Working with Circuits” on page 5-29

“Working with the RF Design and Analysis App Sessions” on page 5-30

Working with Circuits

In addition to building and specifying circuits, the RF Design and Analysis app window allows you to perform the following tasks:

- “Delete a Circuit” on page 5-29
- “Rename a Circuit” on page 5-30

Delete a Circuit

To delete a circuit from your session:

- 1 Select the circuit in the **RF Component List** pane.
- 2 Click **Delete**.

Note: If the circuit you delete is a network, the app deletes the network and everything in the network.

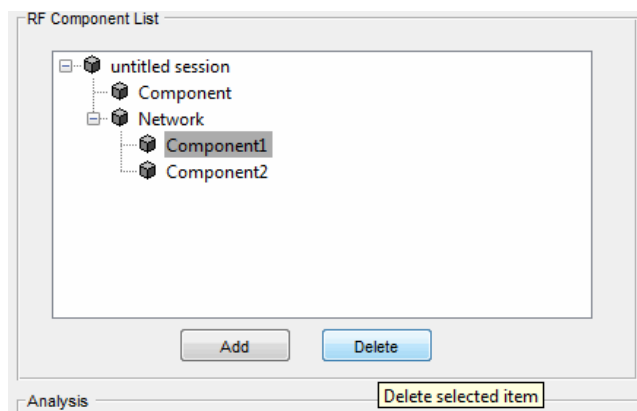

Rename a Circuit

To rename a component or a network:

- 1 Select the component or network in the **RF Component List** pane.
- 2 Type the new name in the **Name** field of the **Component Parameters** pane.
- 3 Click **Apply**.

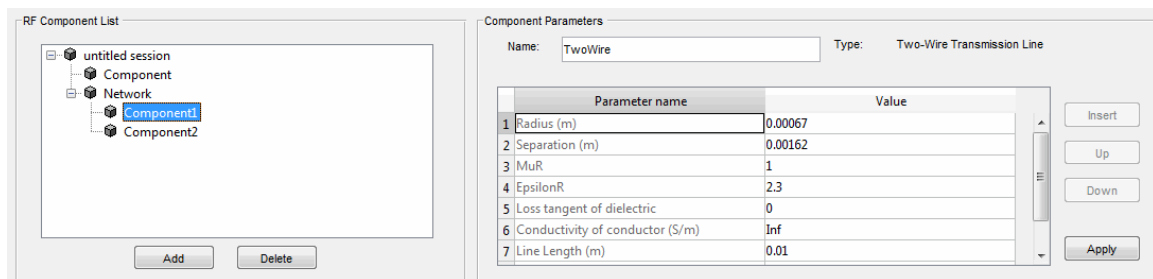

Working with the RF Design and Analysis App Sessions

The work you do with the RF Design and Analysis app is organized into sessions. Each session is a collection of independent RF circuits, which can be RF components or RF networks.

This section contains the following topics:

- “Name or Rename a Session” on page 5-30
- “Save a Session” on page 5-31
- “Open a Session” on page 5-31
- “Start a New Session” on page 5-32

Name or Rename a Session

To name or rename a session:

- 1 Select the session, or top-level node, in the **RF Component List** pane. (The session is selected by default when you open the app user interface.)
- 2 Type the desired name in the **Name** field of the **Component Parameters** pane.

3 Click **Apply**.

Save a Session

To save your session, select **Save Session** or **Save Session As** from the **File** menu. The first time you save a session a browser opens, prompting you for a file name.

Note: The default file name is the session name with any characters that are not alphanumeric converted to underscores (_). The name of the session itself is unchanged.

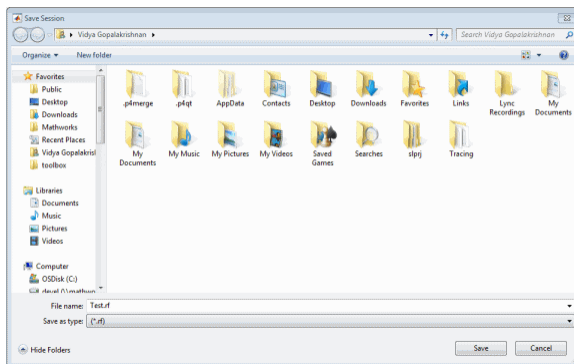

For example, to save your session as **Test.rf** in your current working directory, you would type **Test** in the **File name** field as shown above. The RF Design and Analysis app adds the **.rf** extension automatically to all the app sessions you save.

If the name of your session is **gk's session**, the default file name is **gk_s_session.rf**.

Open a Session

You can load an existing session into the RF Design and Analysis app by selecting **Open Session** from the **File** menu. A browser enables you to select from your previously saved sessions.

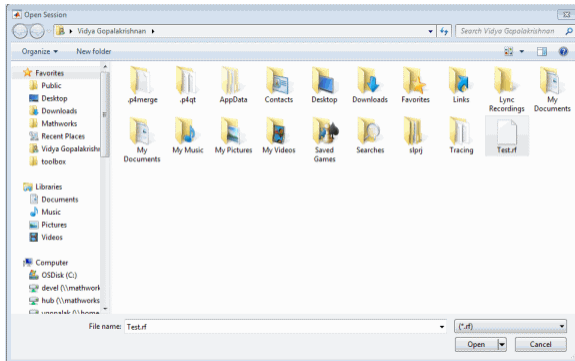

Before opening the requested session, the app prompts you to save your current session.

Start a New Session

To start a new session, select **New Session** from the **File** menu. A new session opens in the app. All its values are set to their defaults.

Before starting a new session, the app prompts you to save your current session.

Model an RF Network

In this section...

“Overview” on page 5-33

“Start the RF Design and Analysis App” on page 5-33

“Create the Amplifier Network” on page 5-33

“Populate the Amplifier Network” on page 5-36

“Analyze the Amplifier Network” on page 5-39

“Export the Network to the Workspace” on page 5-41

Overview

In this example, you model the gain and noise figure of a cascaded network and then analyze the network using the RF Design and Analysis app.

The network used in this example consists of an amplifier and two transmission lines. Here, you learn how to create and analyze the network using the RF Design and Analysis app.

Start the RF Design and Analysis App

Type the following command at the MATLAB prompt to open the app window:

```
rftool
```

For more information about this user interface, see “The RF Design and Analysis Window” on page 5-3.

Create the Amplifier Network

In this part of the example, you create a network to connect the amplifier components in cascade.

- 1 In the **RF Component List** pane, click **Add**.

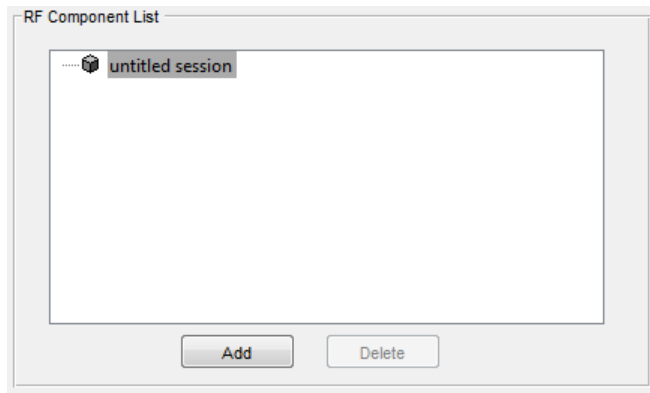

The Create Network or Component dialog box opens.

- 2 In the Create Network or Component dialog box:
 - Select the **Network** option button.
 - In the **Network Name** field, enter Amplifier Network.

This name is used to identify the network in the **RF Component List** pane.

- In the **Network Type** list, select **Cascaded Network**.

A **Cascaded Network** means that when you add components to the network, the app connects them in cascade.

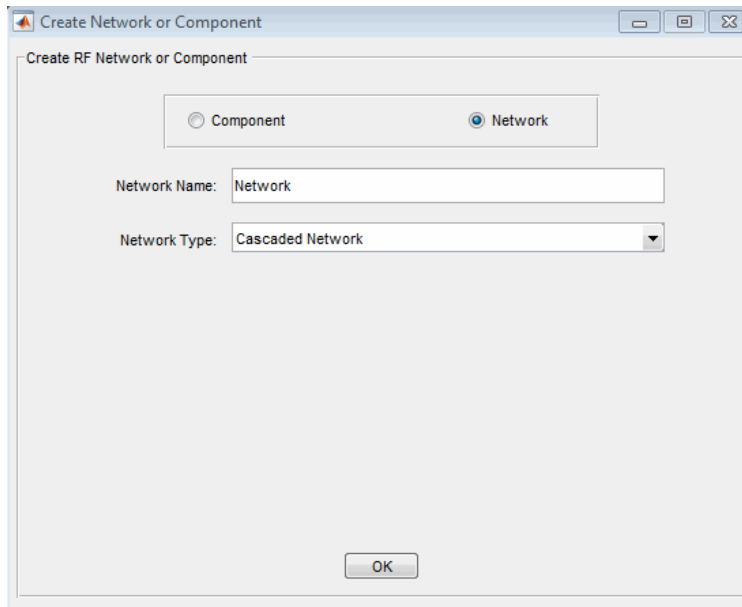

- 3 Click **OK** to add the cascaded network to the session.

The network now appears in the **RF Component List** pane.

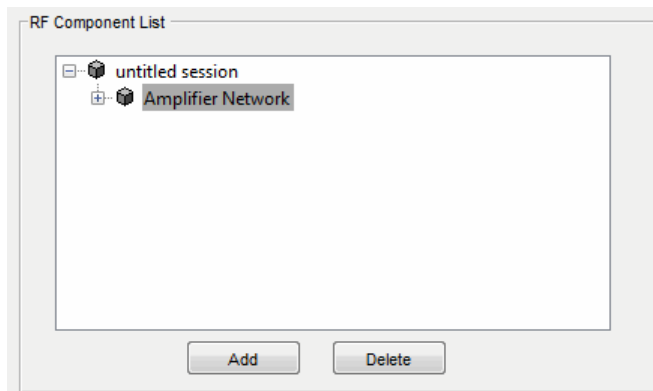

Populate the Amplifier Network

This part of the example shows how to add the following components to the network:

- “Transmission Line 1” on page 5-36
- “Amplifier” on page 5-37
- “Transmission Line 2” on page 5-38

Transmission Line 1

- 1 In the **Component Parameters** pane, click **Insert** to open the Insert Component or Network dialog box.
- 2 In the Insert Component or Network dialog box:

- Select the **Component** option button.
- In the **Component Name** field, enter Short Transmission Line.

This name is used to identify the component in the **RF Component List** pane.

- In the **Component Type** drop-down list, select **Transmission Line**.
- In the **Value** field across from the **Line Length (m)** parameter, enter 0.001.

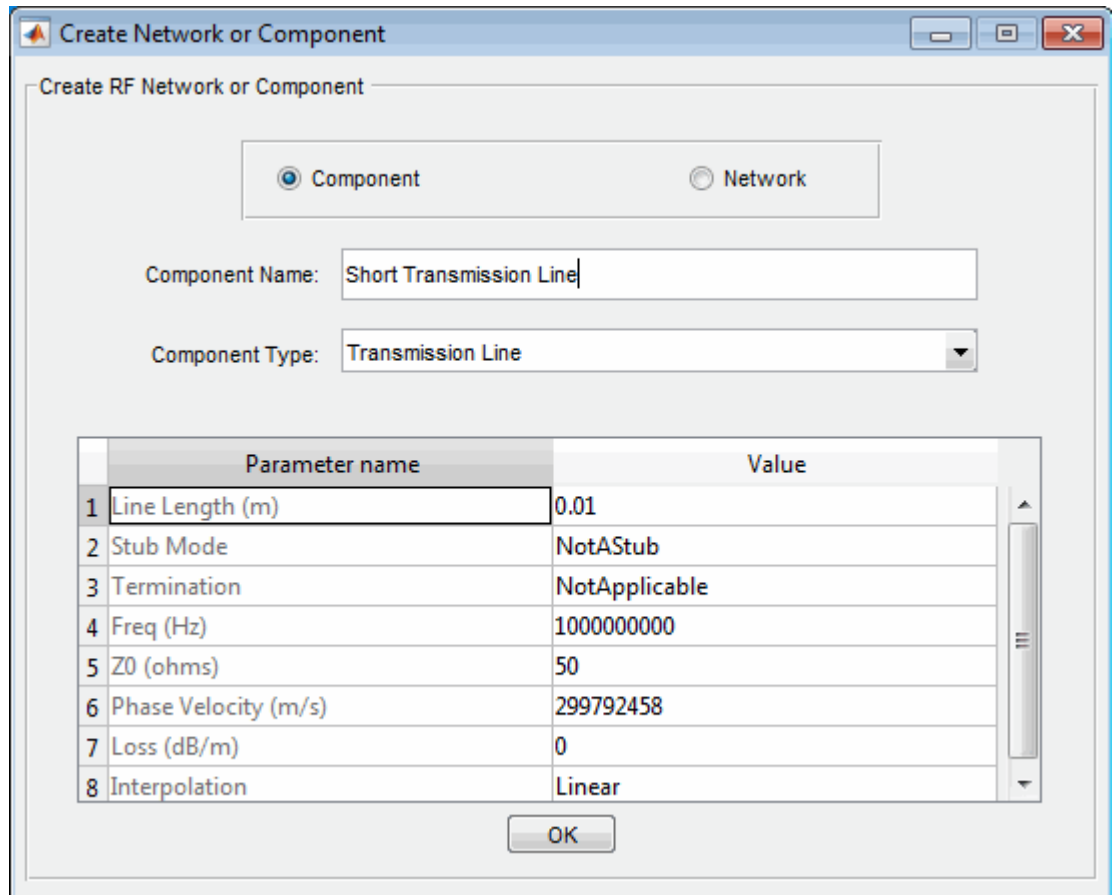

- 3 Click **OK** to add the transmission line to the network.

Amplifier

- 1 In the **Component Parameters** pane, click **Insert** to open the Insert Component or Network dialog box.
- 2 In the Insert Component or Network dialog box:
 - Select the **Component** option button.
 - In the **Component Name** field, enter Amplifier.

This name is used to identify the component in the **RF Component List** pane.

- In the **Component Type** list, select **Data File**.
- In the Import from File dialog box that appears, click **Cancel** . You will specify the name of the file from which to import data in a later step.
- In the **Value** field across from the **Interpolation** parameter, enter **cubic**.

This value tells the app to use cubic interpolation to determine the behavior of the amplifier at frequency values that are not specified explicitly in the data file.

- In the **Value** field across from the **File Name** parameter, enter **default.amp**.

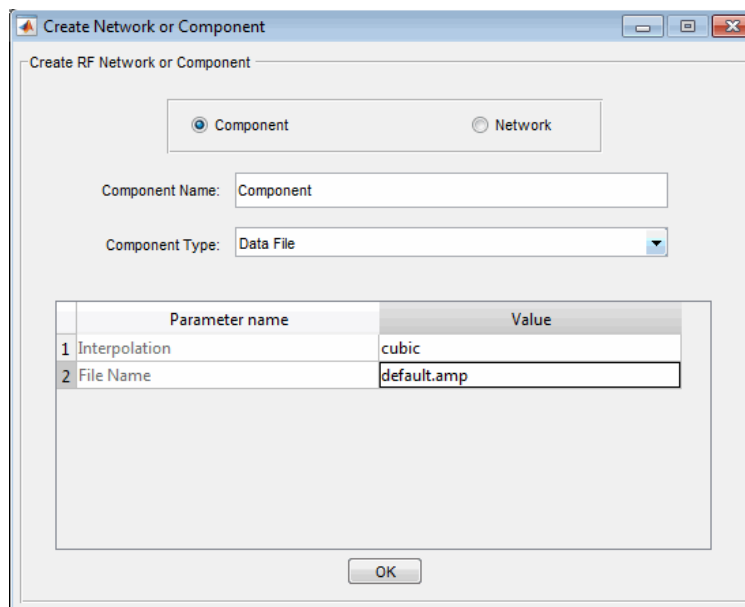

- 3 Click **OK** to add the amplifier to the network.

Transmission Line 2

- 1 In the **Component Parameters** pane, click **Insert** to open the Insert Component or Network dialog box.
- 2 In the Insert Component or Network dialog box, perform the following actions:
 - Select the **Component** option button.

- In the **Component Name** field, enter Long Transmission Line.
This name is used to identify the component in the **RF Component List** pane.
- In the **Component Type** list, select Transmission Line.
- In the **Value** field across from the **Line Length (m)** parameter, enter 0.025.
- In the **Value** field across from the **Phase Velocity (m/s)** parameter, enter 2.0e8.

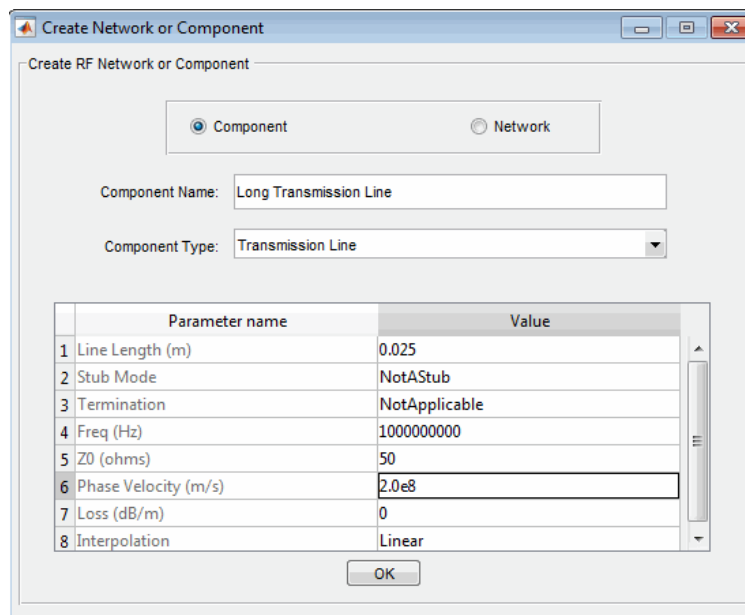

- 3 Click **OK** to add the transmission line to the network.

Analyze the Amplifier Network

In this part of the example, you specify the range of frequencies over which to analyze the amplifier network and then run the analysis.

- 1 In the **Analysis** pane, change the **Frequency** entry to [1.0e9:1e7:2.9e9].

This value specifies an analysis from 1 GHz to 2.9 GHz by 10 MHz.

In the **Analysis** pane, click **Analyze** to simulate the network at the specified frequencies.

The RF Design and Analysis app displays a Smith Chart, an XY plot, and a polar plot of the analyzed circuit.

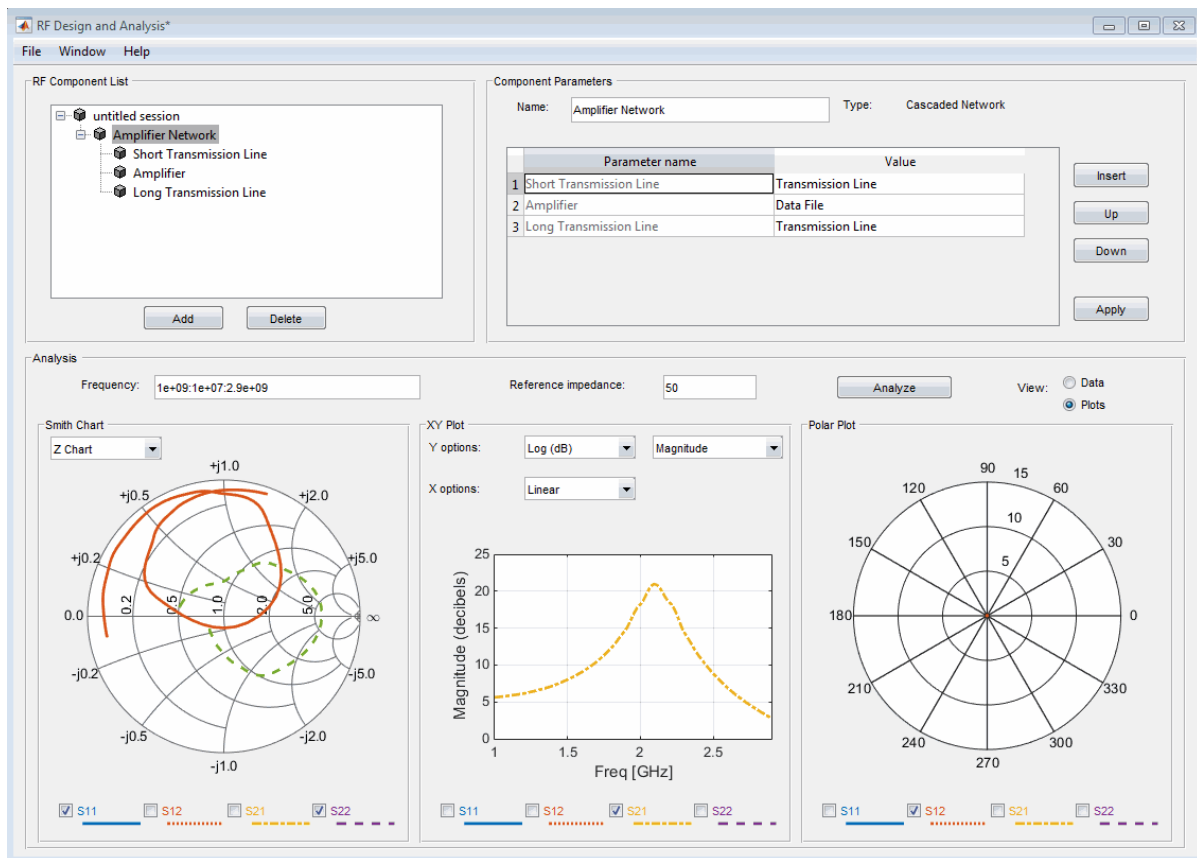

You can modify the plots by

- Selecting and deselecting the S-parameter check boxes at the bottom of each plot to customize the parameters that the plot displays.
- Using the drop-down list at the top of each plot to customize the plot options.

Export the Network to the Workspace

The RF Design and Analysis app lets you export components and networks to the workspace as circuit objects so you can use the RF Toolbox functions to perform additional analysis. This part of the example shows how to export the amplifier network to the workspace.

- 1 In the app window, select **File > Export to Workspace**.
- 2 In the **Variable name** field, enter `CascadedCkt`.

This name is the exported object's handle.

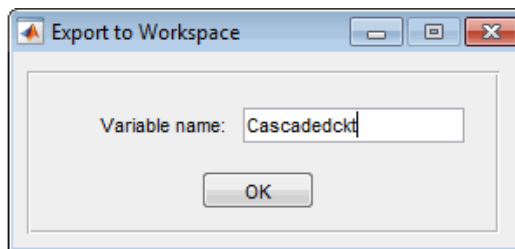

- 3 Click **OK**.

The RF Design and Analysis app exports the amplifier network to an `rfckt.cascade` object, with the specified object handle, in the MATLAB workspace.

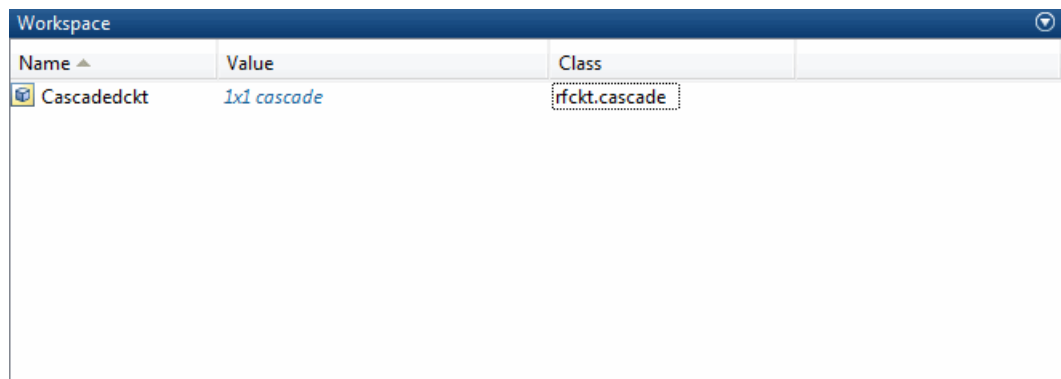
A screenshot of the MATLAB Workspace window. The window title is "Workspace". It contains a table with three columns: "Name", "Value", and "Class".

Name	Value	Class
Cascadedck	1x1 cascade	rfckt.cascade

Objects — Alphabetical List

OpenIF class

Find open intermediate frequencies (IFs) in multiband transmitter or receiver architecture

Description

Use the `OpenIF` class to analyze the spurs and spur-free zones in a multiband transmitter or receiver. This information helps you determine intermediate frequencies (IFs) that do not produce interference in operating bands.

Construction

`hif = OpenIF` creates an intermediate-frequency (IF) planning object with properties set to their default values.

`hif = OpenIF(Name, Value)` creates an intermediate-frequency (IF) planning object with properties with additional options specified by one or more `Name, Value` pair arguments.

`hif = OpenIF(bandwidth)` creates an intermediate-frequency (IF) planning object with a specified IF bandwidth.

`hif = OpenIF(bandwidth, Name, Value)` creates an IF-planning object with a specified IF bandwidth and additional options specified by one or more `Name, Value` pair arguments.

Input Arguments

bandwidth

Specify the bandwidth of the IF signal. The bandwidth is a real positive scalar. The value you provide sets the `IFBW` property of your object. You can also set this property using an optional name-value pair argument.

Name-Value Pair Arguments

Specify optional comma-separated pairs of `Name`, `Value` arguments, where `Name` is the argument name and `Value` is the corresponding value. `Name` must appear inside single quotes (' '). You can specify several name and value pair arguments in any order as `Name1, Value1, . . . , NameN, ValueN`.

'IFLocation' — IF location

'MixerOutput' (default) | 'MixerInput'

Specify an up-conversion or down-conversion setup during object construction. The value you provide sets the `IFLocation` property of your object.

'IFBW' — IF bandwidth

nonnegative number

Specify the IF bandwidth during object construction. The value you provide sets the `IFBW` property of your object. You can also set this property using the optional `bandwidth` input argument.

'SpurFloor' — Spur floor

nonnegative number

Specify the spur floor during object construction. The value you provide sets the `SpurFloor` property of your object.

Properties

IFLocation

Specify an up-conversion or down-conversion setup.

- Setting `IFLocation` to 'MixerInput' specifies an up-converting (transmitting) configuration, where one IF is mixed up to multiple RFs. The following figure shows this convention.

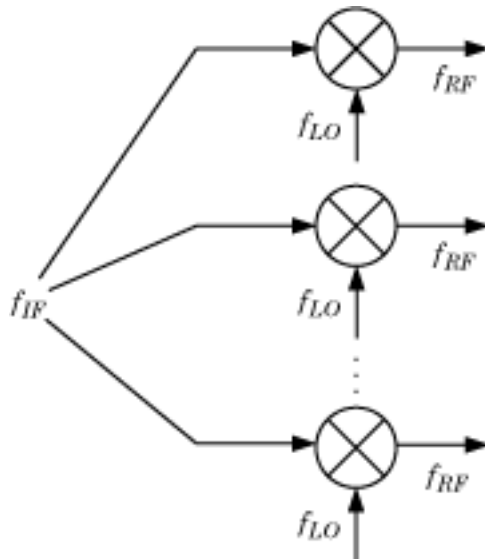

- Setting `IFLocation` to 'MixerOutput' specifies a down-converting (receiving) configuration, where multiple RFs are mixed down to one IF. The following figure shows this convention.

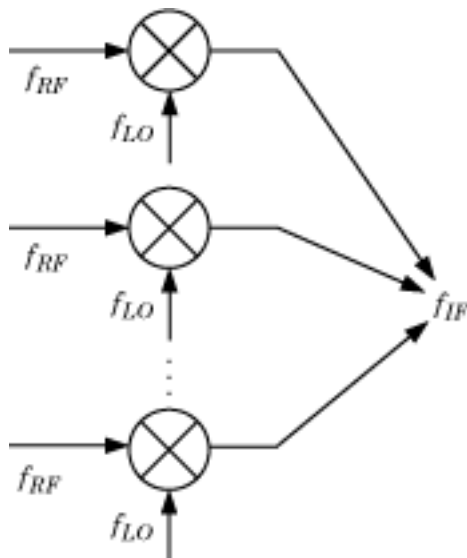

The setting of `IFLocation` determines the available values for the `injection` argument of the `addMixer` method.

Default: 'MixerOutput'

IFBW

Bandwidth of the IF signal in Hz. When you construct the object, the `bandwidth` argument specifies the value of this property.

Mixers

Vector of objects that holds mixer information. When you add mixers using the `addMixer` method, you also add an `OpenIFMixer` object to the `Mixers` vector of your original `OpenIF` object.

The following table lists the properties of each `OpenIFMixer` object.

Property	Description
IMT	Intermodulation table of the mixer.
RFCF	RF center frequency, in Hz.
RFBW	RF bandwidth, in Hz.
MixingType	Mixing (injection) type.
SpurVector	Vector of spur information.

The `IMT`, `RFCF`, `RFBW`, and `MixingType` properties are required inputs to the `addMixer` method.

NumMixers

Number of mixers. When you use the `addMixer` method, the number of mixers increases by one. The likelihood of finding an open IF decreases as you add mixers.

SpurFloor

Maximum difference in magnitude between a signal at 0 dBc and an intermodulation product that the `OpenIF` object considers a spur. The default value of this parameter is 99, corresponding to a spur floor of -99 dBc.

Methods

Copy Semantics

To learn how handle classes use copy operations, see “Using Handles” in the MATLAB documentation.

Examples

Spur-free zones of a multiband receiver

Set up an `OpenIF` object as a multiband receiver, add three mixers to it, and obtain information about its spur-free zones.

Define an `OpenIF` object. The first input is the bandwidth of the IF signal (50 MHz). The `'IFLocation'`, `'MixerOutput'` name-value pair specifies a downconverting configuration.

```
hif = OpenIF(50e6, 'IFLocation', 'MixerOutput');
```

Define the first mixer with an intermodulation table and add it to the `OpenIF` object. Mixer 1 has an LO at 2.4 GHz, has a bandwidth of 100 MHz, and uses low-side injection.

```
IMT1 = [99 00 21 17 26; ...  
        11 00 29 29 63; ...  
        60 48 70 65 41; ...  
        90 89 74 68 87; ...  
        99 99 95 99 99];  
addMixer(hif, IMT1, 2.4e9, 100e6, 'low');
```

Mixer 2 has an LO at 3.7 GHz, has a bandwidth of 150 MHz, and uses low-side injection.

```
IMT2 = [99 00 09 12 15; ...  
        20 00 26 31 48; ...  
        55 70 51 70 53; ...  
        85 90 60 70 94; ...  
        96 95 94 93 92];  
addMixer(hif, IMT2, 3.7e9, 150e6, 'low');
```

Mixer 3 has an LO at 5 GHz, has a bandwidth of 200 MHz, and uses low-side injection.

```

IMT3 = [99 00 15 23 36; ...
        10 00 34 27 59; ...
        67 61 56 59 68; ...
        97 82 81 60 77; ...
        99 99 99 99 96];
addMixer(hif,IMT3,5e9,200e6,'low');

```

The multiband receiver is fully defined and ready for spur-free-zone analysis. Use the `report` method to analyze and display spur and spur-free zone information at the command line. The method also returns information about the mixers in the receiver.

```
hif.report
```

```

Intermediate Frequency (IF) Planner
IF Location: MixerOutput

-- MIXER 1 --
RF Center Frequency: 2.4 GHz
RF Bandwidth: 100 MHz
IF Bandwidth: 50 MHz
MixerType: low
Intermodulation Table:
    99    0   21   17   26
    11    0   29   29   63
    60   48   70   65   41
    90   89   74   68   87
    99   99   95   99   99

-- MIXER 2 --
RF Center Frequency: 3.7 GHz
RF Bandwidth: 150 MHz
IF Bandwidth: 50 MHz
MixerType: low
Intermodulation Table:
    99    0    9   12   15
    20    0   26   31   48
    55   70   51   70   53
    85   90   60   70   94
    96   95   94   93   92

-- MIXER 3 --
RF Center Frequency: 5 GHz
RF Bandwidth: 200 MHz
IF Bandwidth: 50 MHz

```

```
MixerType: low
Intermodulation Table:  99  0  15  23  36
                       10  0  34  27  59
                       67  61  56  59  68
                       97  82  81  60  77
                       99  99  99  99  96
```

```
Spur-Free Zones:
350.00 - 430.00 MHz
530.00 - 556.25 MHz
643.75 - 655.00 MHz
 1.38 - 1.41 GHz
 2.10 - 2.17 GHz
 2.28 - 2.29 GHz
```

Use the `show` method to analyze the receiver and produce an interactive spur graph. Generating a spur graph is a convenient way to summarize the results of the analysis graphically.

```
figure;
hif.show
```

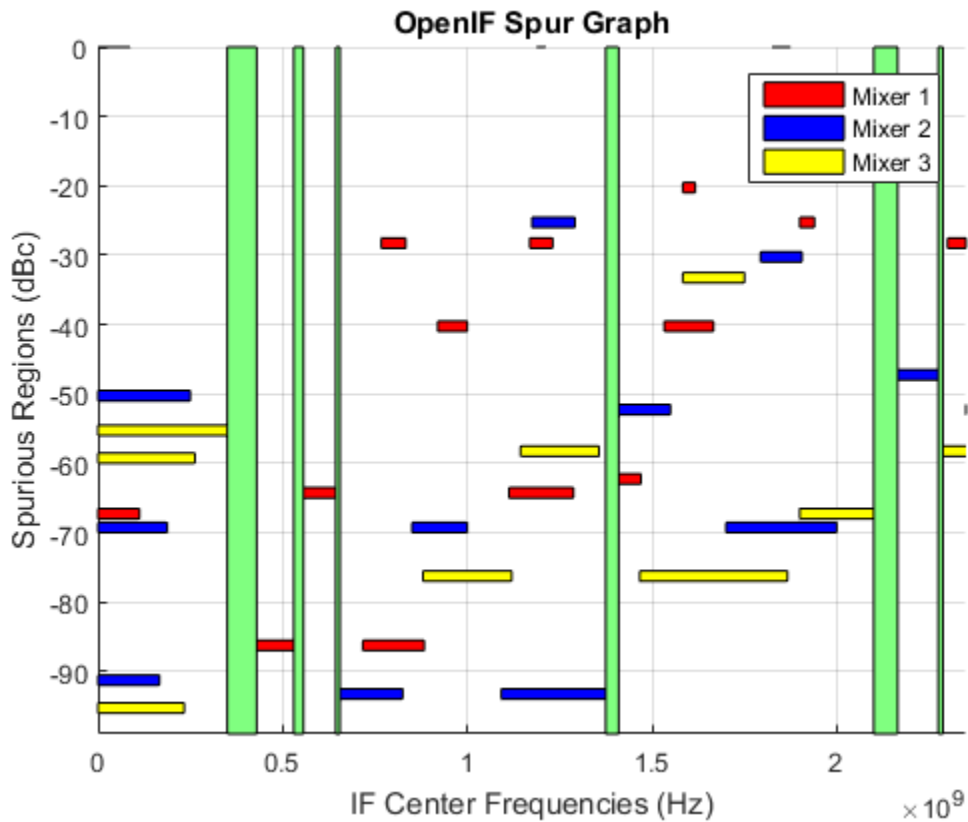

References

Faria, Daniel, Lawrence Dunleavy, and Terje Svensen. "The Use of Intermodulation Tables for Mixer Simulations." *Microwave Journal*. Vol. 45, No. 4, December 2002, p. 60.

capacitor class

Capacitor object

Syntax

```
cobj = capacitor(cvalue)
cobj = capacitor(cvalue,cname)
```

Description

Use the `capacitor` class to create a capacitor object that you can add to an existing circuit.

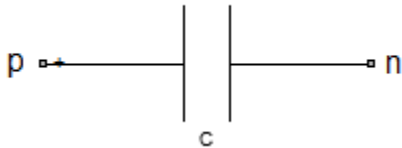

`cobj = capacitor(cvalue)` creates a capacitor object, `cobj`, with a capacitance of `cvalue` and default name, `C`. `cvalue` must be a non-negative scalar.

`cobj = capacitor(cvalue,cname)` creates a capacitor object, `cobj`, with a capacitance of `cvalue` and name `cname`. `cname` must be a string.

Properties

Capacitance — object value

scalar

Capacitance, in farads, of the capacitor object.

Name — Name of capacitor object

`C` (default) | string

Name of capacitor object, specified as a string. Two elements in the same circuit cannot have the same name.

Terminals — Names of terminals of capacitor object

cell vector

Names of the terminals of capacitor object, specified as a cell vector. These names are always p and n.

ParentPath — Full path of the circuit to which the capacitor object belongs

string

Full path of the circuit to which the capacitor object belongs, specified as string. This path appears only after the capacitor is added to the circuit.

ParentNodes — Circuit nodes in the parent nodes connect to capacitor terminals

vector of integers.

Circuit nodes in the parent nodes connect to capacitor terminals, specified as a vector of integers. This property is appears only after the capacitor is added to a circuit.

Examples

Create Capacitor and Display Properties

Create a capacitor of capacitance 2 microfarad and display its properties.

```
hC1 = capacitor(2e-6);
disp(hC1)

capacitor: Capacitor element

    Capacitance: 2.0000e-06
           Name: 'C'
    Terminals: {'p' 'n'}
```

Create and Extract S-parameters of a Capacitor

Create a capacitor and extract S-parameters of the capacitor.

```
hC = capacitor(2e-6, 'C2uf');
```

```
hckt = circuit('example2');
add(hckt,[1 2],hC)
setports(hckt, [1 0],[2 0])
freq = linspace(1e3,2e3,100);
S = sparameters(hckt,freq);
disp(S)
```

```
sparameters: S-parameters object
```

```
    NumPorts: 2
  Frequencies: [100x1 double]
  Parameters: [2x2x100 double]
  Impedance: 50
```

```
rfparam(obj,i,j) returns S-parameter Sij
```

Add Capacitor to Circuit and Display Properties

Add capacitor to a circuit, display the parent path and parent nodes.

```
hC3 = capacitor(3e-6,'C3uf');
hckt3 = circuit('example3');
add(hckt3,[1 2],hC3)
setports(hckt3, [1 0],[2 0])
disp(hC3)
```

```
capacitor: Capacitor element
```

```
  Capacitance: 3.0000e-06
      Name: 'C3uf'
  Terminals: {'p' 'n'}
  ParentNodes: [1 2]
  ParentPath: 'example3'
```

See Also

resistor | inductor | circuit

circuit class

Circuit object

Syntax

```
cktobj = circuit  
cktobj = circuit(cktname)
```

Description

Use `circuit` class to build a circuit object which can contain elements like resistor, capacitor, and inductor.

`cktobj = circuit` creates a circuit object `cktobj` with default name `unnamed`.

`cktobj = circuit(cktname)` creates a circuit object `cktobj` with name of `cktname`.

Properties

Name — Object Name

`unnamed (default) | string`

Name of circuit, specified as a string. Default name is `unnamed`. Two circuit elements attached together or belonging to the same circuit cannot have the same name

ElementNames — Name of elements in the circuit

`vector of strings`

Name of elements in the circuit, specified as a vector of strings. The possible elements here are resistor, capacitor, inductor, and circuit.

Terminals — Names of terminals in the circuit

`vector of strings`

Names of terminals in the circuit, specified as a vector of strings. Use `setterminals` or `setports` function to define the terminals. The terminals of the circuit are only displayed once it is defined.

Ports — Names of ports in a circuit

vector of strings

Names of ports in a circuit specified as a vector of strings. Use `setports` function to define the ports. The ports of the circuit are only displayed once it is defined.

Nodes — List of nodes defined in circuit

vector of integers

List of nodes defined in the circuit, specified as a vector of integers. These nodes are created when a new element is attached to the circuit.

ParentPath — Full path of parent circuit

string

Full path of parent circuit, specified as a string. This path appears only once the child circuit is added to the parent circuit.

ParentNodes — Nodes of parent circuit

vector of integers.

Nodes of parent circuit, specified as a vector of integers. This vector of integers is the same length as the `Terminals` property. This property appears only after the child circuit is added to the parent circuit.

Examples

Create Circuit with Elements and Terminals

Create a circuit called `new_circuit`. Add a resistor and capacitor to the circuit. Set the terminals and display the results.

```
hckt = circuit('new_circuit1');  
hC1= add(hckt,[1 2],capacitor(3e-9));  
hR1 = add(hckt,[2 3],resistor(100));  
setterminals (hckt,[1 3]);  
disp(hckt)
```

```
circuit: Circuit element  
  
ElementNames: {'C' 'R'}  
Nodes: [1 2 3]  
Name: 'new_circuit1'  
Terminals: {'t1' 't2'}
```

Create Circuit with Two Parallel Elements

Create a circuit called `new_circuit`. Add a capacitor and inductor parallel to the circuit.

```
hckt = circuit('new_circuit');  
hC = add(hckt,[1 2],capacitor(1e-12));  
hL = add(hckt,[1 2],inductor(1e-9));  
disp(hckt)
```

```
circuit: Circuit element  
  
ElementNames: {'C' 'L'}  
Nodes: [1 2]  
Name: 'new_circuit'
```

See Also

`resistor` | `capacitor` | `inductor`

inductor class

Inductor object

Syntax

```
lobj = inductor(lvalue)  
lobj = inductor(lvalue, lname)
```

Description

Use `inductor` class to create an inductor object that you can add to an existing circuit.

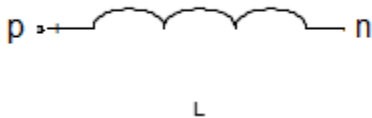

`lobj = inductor(lvalue)` creates a inductor object, `lobj`, with a inductance of `lvalue` and default name, `L`. `lvalue` must be a numeric positive scalar.

`lobj = inductor(lvalue, lname)` creates a inductor object, `lobj`, with a inductance of `lvalue` and name `lname`. `lname` must be a string.

Properties

Inductance — Object value

scalar

Inductance, in henrys, of the inductor object.

Name — Object name

`L` (default) | string

Name of inductor object, specified as a string. Two elements in the same circuit cannot have the same name.

Terminals — Names of terminals of inductor object

cell vector

Names of the terminals of inductor object, specified as a cell vector. These names are always `p` and `n`.

ParentPath — Full path of the circuit to which the inductor object belongs

string

Full path of the circuit to which the inductor object belongs, specified as string. This path appears only after the inductor is added to the circuit.

ParentNodes — Circuit nodes in the parent nodes connect to inductor terminals

vector of integers.

Circuit nodes in the parent nodes connect to inductor terminals, specified as a vector of integers. This property appears only after the inductor is added to a circuit.

Examples

Create and Display Inductor

Create an inductor of $3\text{e-}9$ henry and display the properties.

```
hL1 = inductor(3e-9);
disp(hL1)

inductor: Inductor element

Inductance: 3.0000e-09
Name: 'L'
Terminals: {'p' 'n'}
```

Create and Extract S-parameters of Inductor

Create an inductor object and extract the s-parameters of this inductor.

```
hL = inductor(3e-9, 'L3nh');
```

```
hckt = circuit('example2');
add(hckt,[1 2],hL)
setports(hckt,[1 0],[2 0])
freq = linspace(1e3,2e3,100);
S = sparameters(hckt,freq);
disp(S)
```

```
sparameters: S-parameters object
```

```
    NumPorts: 2
  Frequencies: [100x1 double]
  Parameters: [2x2x100 double]
  Impedance: 50
```

```
rfparam(obj,i,j) returns S-parameter Sij
```

Add Inductor to Circuit and Display Properties

Add an inductor to a circuit, display the parent path and parent nodes.

```
hL = inductor(3e-9,'L3n9');
hckt = circuit('example3');
add(hckt,[1 2],hL)
setports(hckt,[1 0],[2 0])
disp(hL)
```

```
inductor: Inductor element
```

```
    Inductance: 3.0000e-09
      Name: 'L3n9'
  Terminals: {'p' 'n'}
  ParentNodes: [1 2]
  ParentPath: 'example3'
```

See Also

capacitor | resistor | circuit

nport class

Create linear n-port circuit element

Syntax

```
nport_obj = nport(filename)
nport_obj = nport(sparam_obj)
```

Description

The `nport` class creates an n-port object that can be added into an RF Toolbox circuit. The n-port S-parameters define the n-port object.

`nport_obj = nport(filename)` creates an n-port object from the specified `filename`.

`nport_obj = nport(sparam_obj)` creates an n-port object from an S-parameters data object.

Input Arguments

filename — Touchstone data file

string

Touchstone data file, specified as a string, that contains network parameter data. `filename` can be the name of a file on the MATLAB path or the full path to a file. If the file contains data in any other type such as Y-parameters, Z-parameters, then the data is converted to S-parameters.

Example: `*.s2p`

sparam_obj — S-parameters

network parameter object

S-parameters, specified as an RF Toolbox network parameter object. To create this type of object, use the `sparameters` function.

Properties

NumPorts — Number of ports

scalar

Number of ports, specified as a scalar.

Example: 2

NetworkData — S-parameter data

scalar

S-parameter data, specified as a scalar. The linear S-parameter data defines the n-port object.

Example: [1x1 sparameters]

Name — Name of n-port object

scalar handle

Name of n-port object, specified as a scalar handle.

Example: obj

Ports — Port names

cell vector |

Port names, stored as a cell vector. This property is a read only.

Example: {'p1' 'p2'}

Terminals — Terminal names

cell vector

Terminal names, stored as a cell vector. There are two terminals per port. The positive terminal names are listed first ('p1+', 'p2+'...) followed by the negative terminal ('p1-', 'p2-'...). This property is read only.

ParentNodes — Parent circuit nodes connected to n-port object terminals

vector of integers.

Parent circuit nodes connected to n-port object terminals, stored as a vector of integers. **ParentNodes** is same length as **Terminals**. This property is read only and appears only after you add the n-port data.

ParentPath — Full path of circuit to which n-port object belongs

string

Full path of the circuit to which the n-port object belongs, stored as string. This property is read only and appear only after you add the n-port object is added to the circuit.

Examples

Create N-port Object

Create and display N-port data object.

```
npass = nport('passive.s2p')
```

```
npass =
```

```
  nport: N-port element
```

```
    NetworkData: [1x1 sparameters]
```

```
      Name: 'sparams'
```

```
    NumPorts: 2
```

```
    Terminals: {'p1+' 'p2+' 'p1-' 'p2-'}
```

Add N-Port Object to Circuit

Add a N-port object to a circuit. Display the object.

```
nobj = nport('passive.s2p');
```

```
ckt = circuit('example');
```

```
add(ckt,[1 2],nobj)
```

```
disp(nobj)
```

```
  nport: N-port element
```

```
    NetworkData: [1x1 sparameters]
```

```
      Name: 'sparams'
```

```
    NumPorts: 2
```

```
    Terminals: {'p1+' 'p2+' 'p1-' 'p2-'}
```

```
    ParentNodes: [1 2 0 0]
```

```
    ParentPath: 'example'
```

See Also

capacitor | inductor | circuit | resistor

lcladder class

LC ladder object

Syntax

```
lcobj = lcladder(top,l,c)  
lcobj = lcladder(top,l,c,lcname)
```

Description

`lcladder` class creates an LC ladder object that you can add to an existing circuit. Create filters and calculate s-parameters of filters using `lcladder` class. You can also add the `lcladder` object to an existing circuit.

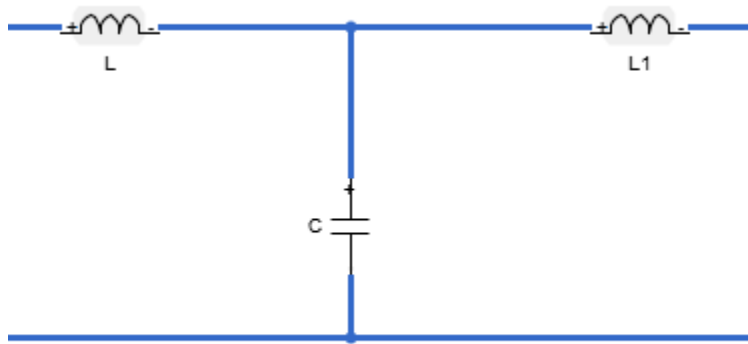

`lcobj = lcladder(top,l,c)` creates an LC ladder object, `lcobj`, with a topology, `top`, inductor values, `l`, and capacitor values, `c`.

`lcobj = lcladder(top,l,c,lcname)` creates an LC ladder object, `lcobj`, with a name, `lcname`. `lcname` must be a string.

Properties

Topology — Topology type of the LC ladder

string

Topology type of the LC ladder, specified as a string:

- 'lowpasspi': Low-pass pi filter
- 'lowpasstee': Low-pass tee filter
- 'highpasspi': High-pass pi filter
- 'highpasstee': High-pass tee filter
- 'bandpasspi': Band-pass pi filter
- 'bandpasstee': Band-pass tee filter
- 'bandstoppi': Band-stop pi filter
- 'bandstoptee': Band-stop tee filter

Set the topology type in the `top` argument of the syntax.

Example: 'lowpasspi'

Inductances — Inductor values in LC ladder

numeric scalar or vector

Inductor values in LC ladder, specified as a numeric scalar or vector. Set the inductor value in the `l` argument of the syntax.

Example: 3.18e-8

Capacitances — Capacitor values in LC ladder

numeric scalar or vector

Capacitor values in LC ladder, specified as a numeric scalar or vector. Set the capacitor value in the `c` argument of the syntax.

Example: [6.37e-12 6.37e-12]

Name — Name of LC ladder object

'lcfilt' (default) | string

Name of LC ladder object, specified as a string. Set the name of the LC ladder in `lcname` argument of the syntax.

NumPorts — Number of ports in LC ladder object

scalar of value 2

Number of ports in LC ladder object. specified as a scalar. This value is always 2.

Terminals — Terminal names of LC ladder object

{'p1+' 'p2+' 'p1-' 'p2-'} | cell vector

Terminal names of LC ladder object, specified as the cell vector, {'p1+' 'p2+' 'p1-' 'p2-'}. An LC ladder object always has four terminals: two terminals associated with the first port ('p1+' and 'p1-') and two terminals associated with the second port ('p2+' and 'p2-').

ParentNodes — Parent circuit nodes connected to LC ladder object terminals

vector of integers

Parent circuit nodes connected to LC ladder object terminals, specified as a vector of integers. This property appears only after the LC ladder object is added to a circuit.

ParentPath — Full path of the circuit to which the LC ladder object belongs

string

Full path of the circuit to which the LC ladder object belongs, specified as string. This path appears only after the inductor is added to the circuit.

Input Arguments

top — Topology type of the LC ladder

string

Topology type of the LC ladder, specified as a string:

- 'lowpasspi': Low-pass pi filter
- 'lowpasstee': Low-pass tee filter
- 'highpasspi': High-pass pi filter
- 'highpasstee': High-pass tee filter
- 'bandpasspi': Band-pass pi filter
- 'bandpasstee': Band-pass tee filter
- 'bandstoppi': Band-stop pi filter
- 'bandstoptee': Band-stop tee filter

Set the topology type in the `top` argument of the syntax.

Example: `'lowpasspi'`

l — Inductor values in LC ladder

numeric scalar or vector

Inductor values in LC ladder, specified as a numeric scalar or vector. Set the inductor value in the `l` argument of the syntax.

Example: `3.18e-8`

c — Capacitor values in LC ladder

numeric scalar or vector

Capacitor values in LC ladder, specified as a numeric scalar or vector. Set the capacitor value in the `c` argument of the syntax.

Example: `[6.37e-12 6.37e-12]`

lcname — Name of LC ladder object

`'lcfilt'` (default) | string

Name of LC ladder object, specified as a string. Set the name of the LC ladder in `lcname` argument of the syntax.

Examples

Create Low-Pass Pi LC Ladder Object and Plot S-Parameters

Create a low-pass pi lc ladder object with inductor value, `3.18e-8` and capacitor value, `6.37e12`. Calculate and plot the s-parameters.

```
L = 3.18e-8;  
C = [6.37e-12 6.37e-12];  
lpp = lcladder('lowpasspi',L,C)
```

```
freq = 0:1e6:1e9;  
S = sparameters(lpp,freq);  
rfplot(S)
```

```
lpp =
```

lcladder: LC Ladder element

Topology: 'lowpasspi'
Inductances: 3.1800e-08
Capacitances: [6.3700e-12 6.3700e-12]
Name: 'lcfilt'
NumPorts: 2
Terminals: {'p1+' 'p2+' 'p1-' 'p2-'}

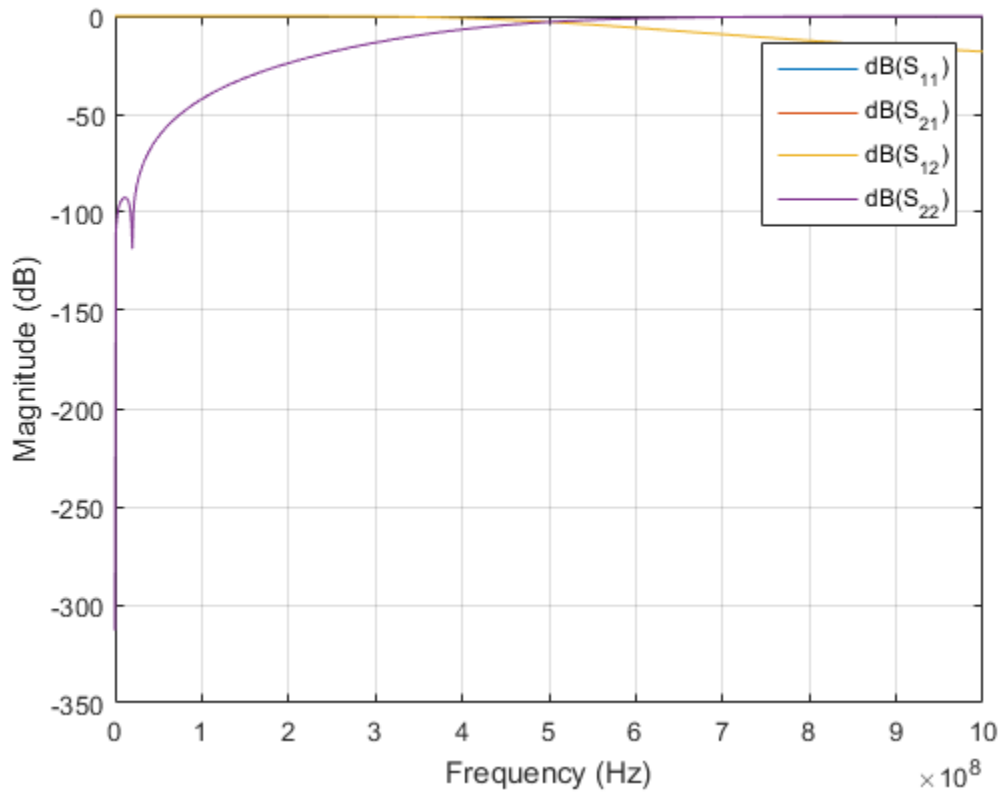

See Also

capacitor | resistor | circuit

Introduced in R2015b

resistor class

Resistor object

Syntax

```
robj = resistor(rvalue)
robj = resistor(rvalue, rname)
```

Description

Use the `resistor` class to create a resistor object that you can add to an existing circuit.



`robj = resistor(rvalue)` creates a resistor object, `robj`, with a resistance of `rvalue` and default name, `R`. `rvalue` must be a numeric non-negative scalar.

`robj = resistor(rvalue, rname)` creates a resistor object, `robj`, with a resistance of `rvalue` and name `rname`. `rname` must be a string.

Properties

Resistance — object value

scalar

Resistance, in ohms, of the resistor object.

Name — Object name

`R` (default) | string

Name of resistor object, specified as a string. Two elements in the same circuit cannot have the same name.

Terminals — Names of terminals of resistor object

cell vector

Names of the terminals of resistor object, specified as a cell vector. These names are always p and n.

ParentPath — Full path of the circuit to which the resistor object belongs

string

Full path of the circuit to which the resistor object belongs, specified as string. This path appears only after the resistor is added to the circuit.

ParentNodes — Circuit nodes in the parent nodes connect to resistor terminals

vector of integers.

Circuit nodes in the parent nodes connect to resistor terminals, specified as a vector of integers. This property appears only after the resistor is added to a circuit.

Examples

Create Resistor and Display Properties

Create a resistor of resistance 100 ohms and display its properties.

```
hR1 = resistor(100);  
disp(hR1)  
  
resistor: Resistor element  
  
Resistance: 100  
Name: 'R'  
Terminals: {'p' 'n'}
```

Create and Extract S-parameters of Resistor

Create an resistor object and extract the s-parameters of this resistor.

```
hR = resistor(50, 'R50');
```

```
hckt = circuit('example2');
add(hckt,[1 2],hR)
setports(hckt,[1 0],[2 0])
freq = linspace(1e3,2e3,100);
S = sparameters(hckt,freq);
disp(S)
```

```
sparameters: S-parameters object
```

```
    NumPorts: 2
  Frequencies: [100x1 double]
  Parameters: [2x2x100 double]
  Impedance: 50
```

```
rfparam(obj,i,j) returns S-parameter Sij
```

Add Resistor to Circuit and Display Properties

Add a resistor to a circuit, display the parent path and parent nodes.

```
hR = resistor(150,'R150');
hckt = circuit('resistorcircuit');
add(hckt,[1 2],hR)
setports(hckt,[1 0],[2 0])
disp(hR)
```

```
resistor: Resistor element
```

```
    Resistance: 150
         Name: 'R150'
   Terminals: {'p' 'n'}
  ParentNodes: [1 2]
  ParentPath: 'resistorcircuit'
```

See Also

capacitor | inductor | circuit

rfchain class

Create `rfchain` object

Syntax

```
obj = rfchain()  
obj = rfchain(g, nf, o3, 'Name', nm)  
obj = rfchain(g, nf, 'IIP3', i3, 'Name', nm)  
obj = rfchain(Name, Value)
```

Description

`obj = rfchain()` creates an RF chain object `obj` having zero stages. To add stages to the RF chain, use `addstage` method.

`obj = rfchain(g, nf, o3, 'Name', nm)` creates an RF chain object `obj` having `N` stages. The gain `g`, noise figure `nf` and the OIP3 `o3` are vectors of length `N`. The name `nm` is a cell array of length `N`.

`obj = rfchain(g, nf, 'IIP3', i3, 'Name', nm)` creates an RF chain object having `N` stages, specifying an IIP3 for each stage, instead of an OIP3.

`obj = rfchain(Name, Value)` specifies one or more properties using name-value pairs.

Properties

Numstages — Number of stages

scalar

Number of stages in an RF chain, returned as a scalar.

Data Types: double

Name — Name of each stage

cell array of strings

Name of each stage of an RF chain, returned as a cell array of strings. This will always be a name-value pair.

Data Types: char

Gain — Gain of each stage

vector

Gain, in dB, of each stage in an RF chain, returned as a vector.

Data Types: double

NoiseFigure — Noise figure of each stage

vector

Noise figure, in dB, of each stage in an RF chain, returned as a vector.

Data Types: double

OIP3 — Output-referred third-order intercept

vector

Output-referred third-order intercept, in dB, of each stage in an RF chain, returned as a vector.

Data Types: double

IIP3 — Input-referred third-order intercept

vector

Input-referred third-order intercept, in dB, of each stage in an RF chain, returned as a vector.

Data Types: double

Methods

addstage	Add stage to RF chain object
setstage	Update RF Chain stage
cumgain	Cascaded gain of the RF chain object

<code>cumnoisefig</code>	Cascaded noise figure of the RF chain object
<code>cumoip3</code>	Cascaded output-referred third-order intercept of the RF chain object
<code>cumiip3</code>	Cascaded input-referred third-order intercept of the RF chain object
<code>plot</code>	Plot RF chain cascaded analysis results
<code>worksheet</code>	RF chain cascaded analysis table

Examples

Create RF Chain Object, Add Stages, and View Results

Create an RF chain object.

```
rfch = rfchain;
```

Add stage 1 and stage 2 with gain, noise figure, oip3.

```
addstage(rfch, 21, 15, 30, 'Name', 'amp1');  
addstage(rfch, -5, 6, Inf, 'Name', 'filt1');
```

Add stage 3 and stage 4 with gain, noise figure, iip3.

```
addstage(rfch, 7, 5, 'IIP3', 10, 'Name', 'lna1');  
addstage(rfch, 12, 14, 'IIP3', 20, 'Name', 'amp2');
```

Calculate the gain, noise figure, oip3, and iip3 of each stage.

```
g = cumgain(rfch);  
nf = cumnoisefig(rfch);  
oip3val = cumoip3(rfch);  
iip3val = cumiip3(rfch);
```

View the results on a table and plot it.

```
worksheet(rfch)  
figure  
plot(rfch)
```

	amp1	filt1	lna1	amp2
Stage Gain	21	-5	7	12
Stage Noise Figure	15	6	5	14
Stage OIP3	30	Inf	17	32
Stage IP3	9	Inf	10	20
Cascaded Gain	21	16	23	35
Cascaded Noise Figure	15	15.0033	15.0107	15.0272
Cascaded OIP3	30	25	16.8648	27.1451
Cascaded IP3	9.0000	9.0000	-6.1352	-7.8549
	< [Progress Bar] >			

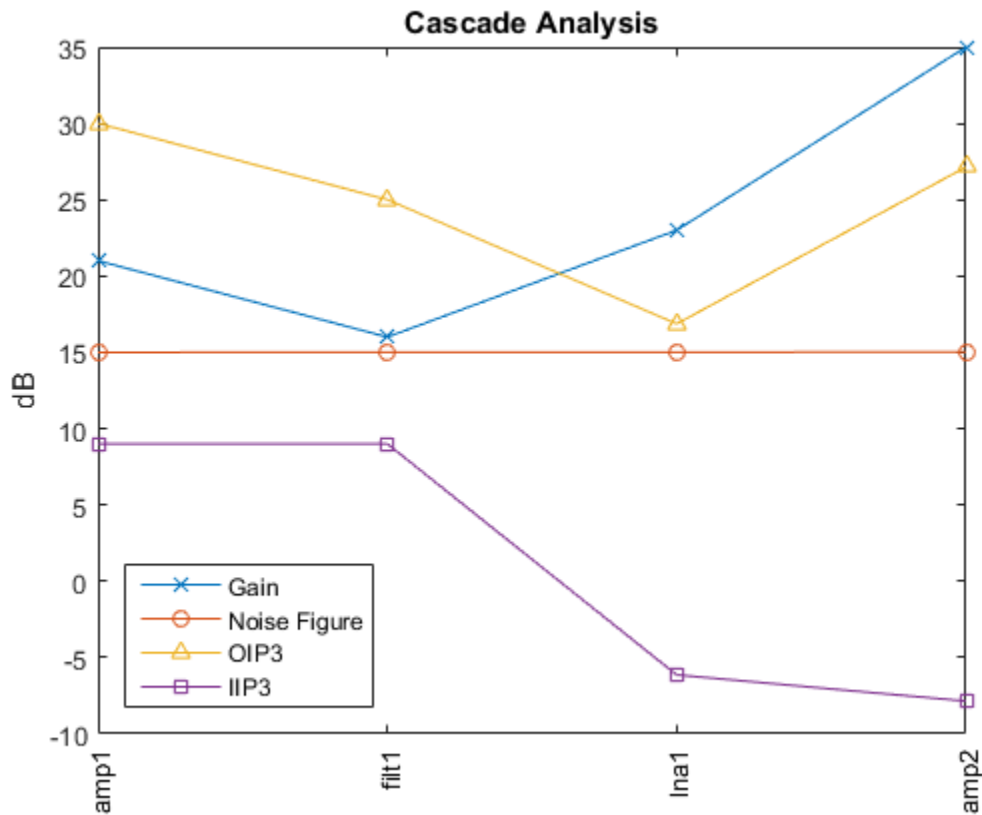

Create RF Chain Adding Stage-By-Stage Values

Assign three stage-by-stage values of gain, noise figure, OIP3 and stage names.

```
g = [11 -3 7];
nf = [25 3 5];
o3 = [30 Inf 10];
nm = {'amp1', 'filt1', 'lna1'};
```

Create an RF chain object `rfch`.

```
rfch = rfchain(g,nf,o3,'Name',nm);
```

View results in a worksheet.

worksheet (rfch)

	amp1	filt1	lna1
Stage Gain	11	-3	7
Stage Noise Figure	25	3	5
Stage OIP3	30	Inf	10
Stage IIP3	19	Inf	3
Cascaded Gain	11	8	15
Cascaded Noise Figure	25	25.0011	25.0058
Cascaded OIP3	30	27	9.9827
Cascaded IIP3	19	19	-5.0173

rfckt.amplifier class

Package: rfckt

RF amplifier

Syntax

```
h = rfckt.amplifier
h = rfckt.amplifier('Property1',value1,'Property2',value2,...)
```

Description

Use the `amplifier` class to represent RF amplifiers that are characterized by network parameters, noise data, and nonlinearity data.

`h = rfckt.amplifier` returns an amplifier circuit object whose properties all have their default values.

`h = rfckt.amplifier('Property1',value1,'Property2',value2,...)` returns a circuit object, `h`, based on the specified properties. Properties that you do not specify retain their default values.

Use the `read` method to read the amplifier data from a data file in one of the following formats:

- Touchstone
- Agilent P2D
- Agilent S2D
- AMP

See for information about the `.amp` format.

Note: If you set `NonLinearData` using `rfdata.ip3` or `rfdata.power`, then the property is converted from scalar OIP3 format to the format of `rfdata.ip3` or `rfdata.power`.

Properties

AnalyzedResult	Computed S-parameters, noise figure, OIP3, and group delay values
IntpType	Interpolation method
Name	Object name
NetworkData	Network parameter information
NoiseData	Noise information
NonlinearData	Nonlinearity information
nPort	Number of ports

Methods

Examples

Create RF Circuit Amplifier

Create an Amplifier using rfckt.amplifier object.

```
amp = rfckt.amplifier('IntpType','cubic')
```

```
amp =
```

```
rfckt.amplifier with properties:
```

```
    NoiseData: [1x1 rfdata.noise]
  NonlinearData: [1x1 rfdata.power]
         IntpType: 'Cubic'
    NetworkData: [1x1 rfdata.network]
         nPort: 2
  AnalyzedResult: [1x1 rfdata.data]
         Name: 'Amplifier'
```

References

EIA/IBIS Open Forum, *Touchstone File Format Specification*, Rev. 1.1, 2002 (http://www.vhdl.org/pub/ibis/connector/touchstone_spec11.pdf).

See Also

`rfckt.datafile` | `rfckt.mixer` | `rfckt.passive` | `rfdata.data` | `rfdata.ip3` | `rfdata.network` | `rfdata.nf` | `rfdata.noise` | `rfdata.power`

rfckt.cascade class

Package: rfckt

Cascaded network

Syntax

```
h = rfckt.cascade
```

```
h = rfckt.cascade('Property1',value1,'Property2',value2,...)
```

Description

Use the `cascade` class to represent cascaded networks of RF objects that are characterized by the components that make up the network. The following figure shows the configuration of a pair of cascaded networks.

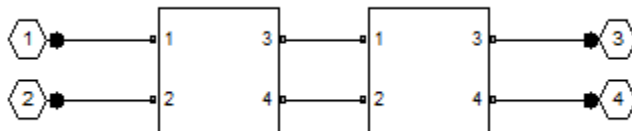

`h = rfckt.cascade` returns a cascaded network object whose properties all have their default values.

`h = rfckt.cascade('Property1',value1,'Property2',value2,...)` returns a cascaded network object, `h`, based on the specified properties. Properties you do not specify retain their default values.

Properties

AnalyzedResult

Computed S-parameters, noise figure, OIP3, and group delay values

Ckts	Circuit objects in network
Name	Object name
nPort	Number of ports

Methods

Examples

Create RF Circuit Cascade Network

Create a cascade network using `rfckt.cascade` with amplifier and transmission lines as elements.

```
amp = rfckt.amplifier('IntpType','cubic');  
tx1 = rfckt.txline;  
tx2 = rfckt.txline;  
casccircuit = rfckt.cascade('Ckts',{tx1,amp,tx2})
```

```
casccircuit =  
  
    rfckt.cascade with properties:  
  
        Ckts: {1x3 cell}  
        nPort: 2  
    AnalyzedResult: []  
        Name: 'Cascaded Network'
```

References

Ludwig, R. and P. Bretchko, *RF Circuit Design: Theory and Applications*, Prentice Hall, 2000.

See Also

`rfckt.hybrid` | `rfckt.hybridg` | `rfckt.parallel` | `rfckt.series`

rfckt.coaxial class

Package: rfckt

Coaxial transmission line

Syntax

```
h = rfckt.coaxial
```

```
h = rfckt.coaxial('Property1',value1,'Property2',value2,...)
```

Description

Use the `coaxial` class to represent coaxial transmission lines that are characterized by line dimensions, stub type, and termination.

A coaxial transmission line is shown in cross-section in the following figure. Its physical characteristics include the radius of the inner conductor of the coaxial transmission line a , and the radius of the outer conductor b .

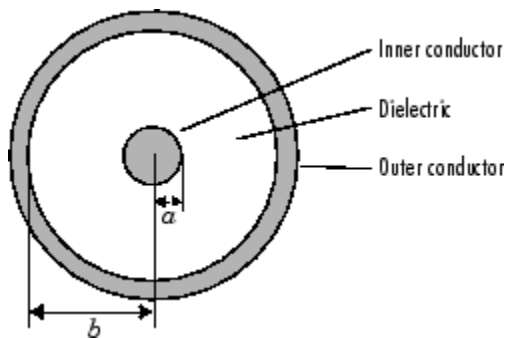

`h = rfckt.coaxial` returns a coaxial transmission line object whose properties are set to their default values.

`h = rfckt.coaxial('Property1',value1,'Property2',value2,...)` returns a coaxial transmission line object, `h`, with the specified properties. Properties that you do not specify retain their default values.

Properties

AnalyzedResult	Computed S-parameters, noise figure, OIP3, and group delay values
EpsilonR	Relative permittivity of dielectric
InnerRadius	Inner conductor radius
LineLength	Transmission line length
LossTangent	Tangent of loss angle
MuR	Relative permeability of dielectric
Name	Object name
OuterRadius	Outer conductor radius
SigmaCond	Conductor conductivity
StubMode	Type of stub
Termination	Stub transmission line termination
nPort	Number of ports

Methods

Examples

Create Coaxial Transmission Line

Create a coaxial transmission line with 0.0045 meters outer radius using `rfckt.coaxial`.

```
tx1=rfckt.coaxial('OuterRadius',0.0045)
```

```
tx1 =
```

```
    rfckt.coaxial with properties:
```

```
    OuterRadius: 0.0045  
    InnerRadius: 7.2500e-04  
             MuR: 1  
    EpsilonR: 2.3000
```



```
LossTangent: 0
  SigmaCond: Inf
  LineLength: 0.0100
  StubMode: 'NotAStub'
  Termination: 'NotApplicable'
    nPort: 2
AnalyzedResult: []
  Name: 'Coaxial Transmission Line'
```

References

Pozar, David M. *Microwave Engineering*, John Wiley & Sons, Inc., 2005.

See Also

rfckt.cpw | rfckt.microstrip | rfckt.parallelplate | rfckt.rlcgline |
rfckt.twowire | rfckt.txline

rfckt.cpw class

Package: rfckt

Coplanar waveguide transmission line

Syntax

```
h = rfckt.cpw
h = rfckt.cpw('Property1',value1,'Property2',value2,...)
```

Description

Use the `cpw` class to represent coplanar waveguide transmission lines that are characterized by line dimensions, stub type, and termination.

A coplanar waveguide transmission line is shown in cross-section in the following figure. Its physical characteristics include the conductor width (w), the conductor thickness (t), the slot width (s), the substrate height (d), and the permittivity constant (ϵ).

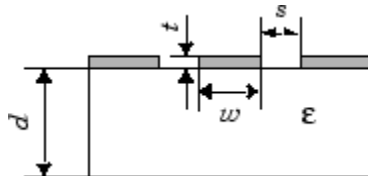

`h = rfckt.cpw` returns a coplanar waveguide transmission line object whose properties are set to their default values.

`h = rfckt.cpw('Property1',value1,'Property2',value2,...)` returns a coplanar waveguide transmission line object, `h`, with the specified properties. Properties that you do not specify retain their default values.

Properties

AnalyzedResult

Computed S-parameters, noise figure, OIP3, and group delay values

ConductorWidth	Conductor width
EpsilonR	Relative permittivity of dielectric
Height	Dielectric thickness
LineLength	Transmission line length
LossTangent	Tangent of loss angle
Name	Object name
SigmaCond	Conductor conductivity
SlotWidth	Width of slot
StubMode	Type of stub
Termination	Stub transmission line termination
Thickness	Conductor thickness
nPort	Number of ports

Methods

Examples

Create Coplanar Waveguide Transmission Line

Create a coplanar waveguide transmission line using rfckt.cpw.

```
tx=rfckt.cpw('Thickness',0.0075e-6)
```

```
tx =
```

```
rfckt.cpw with properties:
```

```
ConductorWidth: 6.0000e-04
SlotWidth: 2.0000e-04
Height: 6.3500e-04
Thickness: 7.5000e-09
EpsilonR: 9.8000
LossTangent: 0
SigmaCond: Inf
```

```
LineLength: 0.0100
StubMode: 'NotAStub'
Termination: 'NotApplicable'
nPort: 2
AnalyzedResult: []
Name: 'Coplanar Waveguide Transmission Line'
```

References

[1] Gupta, K. C., R. Garg, I. Bahl, and P. Bhartia, *Microstrip Lines and Slotlines*, 2nd Edition, Artech House, Inc., Norwood, MA, 1996.

See Also

[rfckt.coaxial](#) | [rfckt.microstrip](#) | [rfckt.parallelplate](#) | [rfckt.rlcgline](#)
| [rfckt.twowire](#) | [rfckt.txline](#)

rfckt.datafile class

Package: rfckt

Component or network from file data

Syntax

```
h = rfckt.datafile
h = rfckt.datafile('Property1',value1,'Property2',value2,...)
```

Description

Use the `datafile` class to represent RF components and networks that are characterized by measured or simulated data in a file.

`h = rfckt.datafile` returns a circuit object whose properties all have their default values.

`h = rfckt.datafile('Property1',value1,'Property2',value2,...)` returns a circuit object, `h`, based on the specified properties. Properties that you do not specify retain their default values.

Use the `read` method to read the data from a file in one of the following formats:

- Touchstone
- Agilent P2D
- Agilent S2D
- AMP

See for information about the `.amp` format.

Properties

AnalyzedResult

Computed S-parameters, noise figure, OIP3, and group delay values

File	File containing circuit data
IntpType	Interpolation method
Name	Object name
nPort	Number of ports

Methods

Examples

Represent RF Components and Networks In Data File.

Represent RF components and networks that are characterized by measured or simulated data in a file using `rfckt.datafile`.

```
data=rfckt.datafile('File','default.s2p')
```

```
data =
```

```
rfckt.datafile with properties:
```

```
IntpType: 'Linear'  
File: 'default.s2p'  
nPort: 2  
AnalyzedResult: [1x1 rfdata.data]  
Name: 'Data File'
```

References

EIA/IBIS Open Forum, *Touchstone File Format Specification*, Rev. 1.1, 2002 (http://www.vhdl.org/pub/ibis/connector/touchstone_spec11.pdf).

See Also

`rfckt.amplifier` | `rfckt.mixer` | `rfckt.passive` | http://www.vhdl.org/pub/ibis/connector/touchstone_spec11.pdf

rfckt.delay class

Package: rfckt

Delay line

Syntax

```
h = rfckt.delay
h = rfckt.delay('Property1',value1,'Property2',value2,...)
```

Description

Use the `delay` class to represent delay lines that are characterized by line loss and time delay.

`h = rfckt.delay` returns a delay line object whose properties are set to their default values.

`h = rfckt.delay('Property1',value1,'Property2',value2,...)` returns a delay line object, `h`, with the specified properties. Properties that you do not specify retain their default values.

Properties

AnalyzedResult	Computed S-parameters, noise figure, OIP3, and group delay values
Loss	Delay line loss
Name	Object name
TimeDelay	Delay introduced by line
Z0	Characteristic impedance
nPort	Number of ports

Methods

Examples

Represent Delay Lines

Represent delay lines that are characterized by line loss and time delay using `rfckt.delay`.

```
del=rfckt.delay('TimeDelay',1e-11)
```

```
del =
```

```
    rfckt.delay with properties:
```

```
        Z0: 50.0000 + 0.0000i
        Loss: 0
        TimeDelay: 1.0000e-11
        nPort: 2
        AnalyzedResult: []
        Name: 'Delay Line'
```

References

Ludwig, R. and P. Bretchko, *RF Circuit Design: Theory and Applications*, Prentice-Hall, 2000.

See Also

`rfckt.rlcgline` | `rfckt.txline`

rfckt.hybrid class

Package: rfckt

Hybrid connected network

Syntax

```
h = rfckt.hybrid
h = rfckt.hybrid('Property1',value1,'Property2',value2,...)
```

Description

Use the `hybrid` class to represent hybrid connected networks of linear RF objects that are characterized by the components that make up the network.

`h = rfckt.hybrid` returns a hybrid connected network object whose properties all have their default values.

`h = rfckt.hybrid('Property1',value1,'Property2',value2,...)` returns a hybrid connected network object, `h`, based on the specified properties. Properties that you do not specify retain their default values.

Properties

AnalyzedResult	Computed S-parameters, noise figure, OIP3, and group delay values
Ckts	Circuit objects in network
Name	Object name
nPort	Number of ports

Methods

Examples

Create Hybrid Connected Networks

Create hybrid connected networks of linear RF objects with two transmission line objects using `rfckt.hybrid`.

```
tx1 = rfckt.txline;  
tx2 = rfckt.txline;  
hyb = rfckt.hybrid('Ckts',{tx1,tx2})
```

```
hyb =
```

```
rfckt.hybrid with properties:
```

```
    Ckts: {[1x1 rfckt.txline] [1x1 rfckt.txline]}  
    nPort: 2  
    AnalyzedResult: []  
    Name: 'Hybrid Connected Network'
```

References

Ludwig, R. and P. Bretchko, *RF Circuit Design: Theory and Applications*, Prentice-Hall, 2000.

See Also

`rfckt.cascade` | `rfckt.hybrid` | `rfckt.parallel` | `rfckt.series`

rfckt.hybridg class

Package: rfckt

Inverse hybrid connected network

Syntax

```
h = rfckt.hybridg
h = rfckt.hybridg('Property1',value1,'Property2',value2,...)
```

Description

Use the `hybridg` class to represent inverse hybrid connected networks of linear RF objects that are characterized by the components that make up the network.

`h = rfckt.hybridg` returns an inverse hybrid connected network object whose properties all have their default values.

`h = rfckt.hybridg('Property1',value1,'Property2',value2,...)` returns an inverse hybrid connected network object, `h`, based on the specified properties. Properties that you do not specify retain their default values.

Properties

AnalyzedResult	Computed S-parameters, noise figure, OIP3, and group delay values
Ckts	Circuit objects in network
Name	Object name
nPort	Number of ports

Methods

Examples

Create Inverse Hybrid Connected Networks

Create inverse hybrid connected networks of linear RF objects with two transmission line objects using `rfckt.hybridg`.

```
tx1 = rfckt.txline;  
tx2 = rfckt.txline;  
invhyb = rfckt.hybridg('Ckts',{tx1,tx2})
```

```
invhyb =
```

```
rfckt.hybridg with properties:
```

```
    Ckts: {[1x1 rfckt.txline] [1x1 rfckt.txline]}  
    nPort: 2  
    AnalyzedResult: []  
    Name: 'Hybrid G Connected Network'
```

References

Davis, A.M., *Linear Circuit Analysis*, PWS Publishing Company, 1998.

See Also

`rfckt.cascade` | `rfckt.hybrid` | `rfckt.parallel` | `rfckt.series`

rfckt.lcbandpasspi class

Package: rfckt

Bandpass pi filter

Syntax

```
h = rfckt.lcbandpasspi
h = rfckt.lcbandpasspi('Property1',value1,'Property2',value2,...)
```

Description

Use the `lcbandpasspi` class to represent a bandpass pi filter as a network of inductors and capacitors.

The LC bandpass pi network object is a 2-port network as shown in the following circuit diagram.

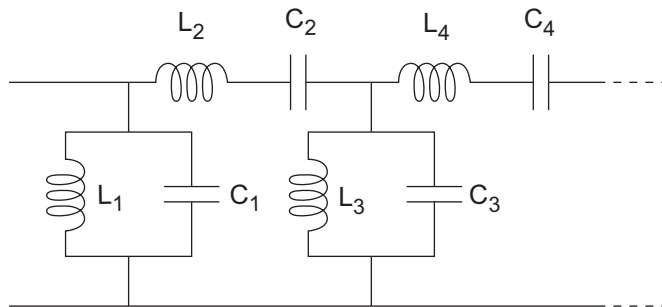

In the diagram, $[L_1, L_2, L_3, L_4, \dots]$ is the value of the 'L' object property, and $[C_1, C_2, C_3, C_4, \dots]$ is the value of the 'C' object property.

`h = rfckt.lcbandpasspi` returns an LC bandpass pi network object whose properties all have their default values.

`h = rfckt.lcbandpasspi('Property1',value1,'Property2',value2,...)` returns an LC bandpass pi network object, `h`, based on the specified properties. Properties that you do not specify retain their default values.

Properties

AnalyzedResult	Computed S-parameters, noise figure, OIP3, and group delay values
C	Capacitance data
L	Inductance data
Name	Object name
nPort	Number of ports

Methods

Examples

Create LC BandPass Pi Filter

Create an LC bandpass filter of capacitor values $1e-12$ and $4e12$ farads, inductor values $2e-9$ and $2.5e-9$ henries.

```
filter = rfckt.lcbandpasspi('C',[1e-12 4e-12], 'L',[2e-9 2.5e-9])
```

```
filter =
```

```
    rfckt.lcbandpasspi with properties:
```

```
        L: [2x1 double]
        C: [2x1 double]
    nPort: 2
AnalyzedResult: []
        Name: 'LC Bandpass Pi'
```

References

Ludwig, R. and P. Bretchko, *RF Circuit Design: Theory and Applications*, Prentice-Hall, 2000.

Zverev, A.I., *Handbook of Filter Synthesis*, John Wiley & Sons, 1967.

See Also

rfckt.lcbandpasstee | rfckt.lcbandstoppi | rfckt.lcbandstoptee
| rfckt.lchighpasspi | rfckt.lchighpasstee | rfckt.lclowpasspi |
rfckt.lclowpasstee

rfckt.lcbandpasstee class

Package: rfckt

Bandpass tee filter

Syntax

```
h = rfckt.lcbandpasstee
```

```
h = rfckt.lcbandpasstee('Property1',value1,'Property2',value2,...)
```

Description

Use the `lcbandpasstee` class to represent a bandpass tee filter as a network of inductors and capacitors.

The LC bandpass tee network object is a 2-port network as shown in the following circuit diagram.

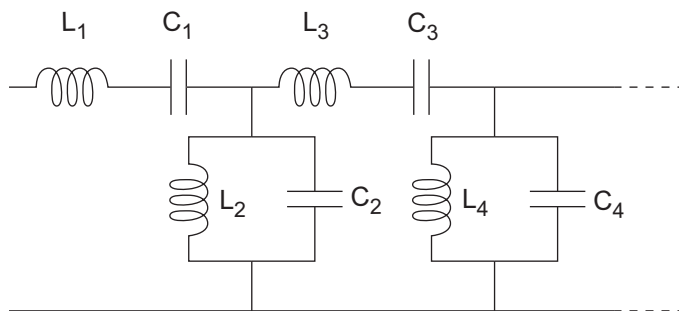

In the diagram, [$L_1, L_2, L_3, L_4, \dots$] is the value of the 'L' object property, and [$C_1, C_2, C_3, C_4, \dots$] is the value of the 'C' object property.

`h = rfckt.lcbandpasstee` returns an LC bandpass tee network object whose properties all have their default values.

`h = rfckt.lcbandpasstee('Property1',value1,'Property2',value2,...)` returns an LC bandpass tee network object, `h`, based on the specified properties. Properties that you do not specify retain their default values.

Properties

AnalyzedResult	Computed S-parameters, noise figure, OIP3, and group delay values
C	Capacitance data
L	Inductance data
Name	Object name
nPort	Number of ports

Methods

Examples

```
filter = rfckt.lcbandpasstee...
        ('C',[1e-12 4e-12], 'L',[2e-9 2.5e-9])
```

```
filter =
```

```
    Name: 'LC Bandpass Tee'
    nPort: 2
    AnalyzedResult: []
    L: [2x1 double]
    C: [2x1 double]
```

References

Ludwig, R. and P. Bretchko, *RF Circuit Design: Theory and Applications*, Prentice-Hall, 2000.

Zverev, A.I., *Handbook of Filter Synthesis*, John Wiley & Sons, 1967.

See Also

```
rfckt.lcbandpasspi | rfckt.lcbandstoppi | rfckt.lcbandstoptee |
rfckt.lchighpasspi | rfckt.lchighpasstee | rfckt.lclowpasspi |
rfckt.lclowpasstee
```

rfckt.lcbandstoppi class

Package: rfckt

Bandstop pi filter

Syntax

```
h = rfckt.lcbandstoppi
h = rfckt.lcbandstoppi('Property1',value1,'Property2',value2,...)
```

Description

Use the `lcbandstoppi` class to represent a bandstop pi filter as a network of inductors and capacitors. The LC bandstop pi network object is a 2-port network as shown in the following circuit diagram.

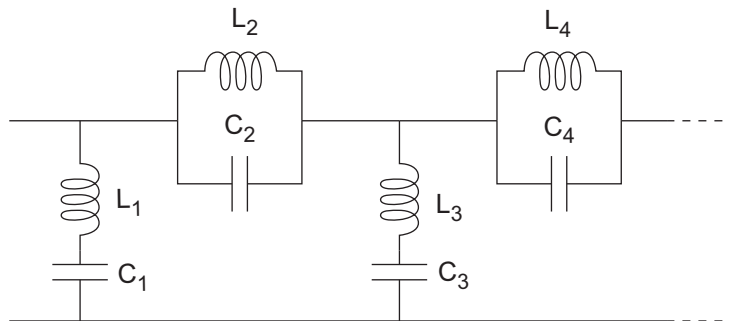

In the diagram, $[L_1, L_2, L_3, L_4, \dots]$ is the value of the 'L' object property, and $[C_1, C_2, C_3, C_4, \dots]$ is the value of the 'C' object property.

`h = rfckt.lcbandstoppi` returns an LC bandstop pi network object whose properties all have their default values.

`h = rfckt.lcbandstoppi('Property1',value1,'Property2',value2,...)` returns an LC bandstop pi network object, `h`, based on the specified properties. Properties that you do not specify retain their default values.

Properties

AnalyzedResult	Computed S-parameters, noise figure, OIP3, and group delay values
C	Capacitance data
L	Inductance data
Name	Object name
nPort	Number of ports

Methods

Examples

```
filter = rfckt.lcbandstoppi...
        ('C',[1e-12 4e-12], 'L',[2e-9 2.5e-9])
```

```
filter =
```

```
    Name: 'LC Bandstop Pi'
    nPort: 2
    AnalyzedResult: []
    L: [2x1 double]
    C: [2x1 double]
```

References

Ludwig, R. and P. Bretchko, *RF Circuit Design: Theory and Applications*, Prentice-Hall, 2000.

Zverev, A.I., *Handbook of Filter Synthesis*, John Wiley & Sons, 1967.

See Also

```
rfckt.lcbandpasspi | rfckt.lcbandpasstee | rfckt.lcbandstoptee
| rfckt.lchighpasspi | rfckt.lchighpasstee | rfckt.lclowpasspi |
rfckt.lclowpasstee
```

rfckt.lcbandstoptee class

Package: rfckt

Bandstop tee filter

Syntax

```
h = rfckt.lcbandstoptee
h = rfckt.lcbandstoptee('Property1',value1,'Property2',value2,...)
```

Description

Use the `lcbandstoptee` class to represent a bandstop tee filter as a network of inductors and capacitor. The LC bandstop tee network object is a 2-port network as shown in the following circuit diagram.

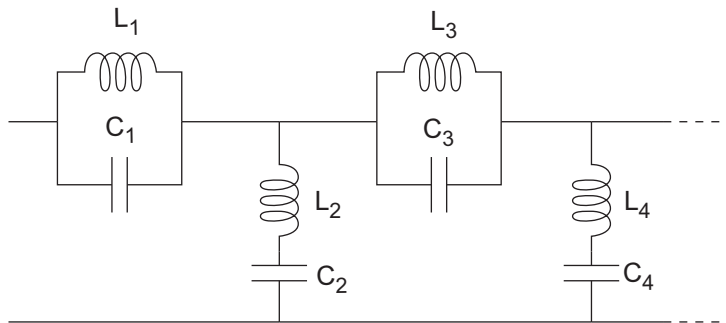

In the diagram, [$L_1, L_2, L_3, L_4, \dots$] is the value of the 'L' object property, and [$C_1, C_2, C_3, C_4, \dots$] is the value of the 'C' object property.

`h = rfckt.lcbandstoptee` returns an LC bandstop tee network object whose properties all have their default values.

`h = rfckt.lcbandstoptee('Property1',value1,'Property2',value2,...)` returns an LC bandstop tee network object, `h`, based on the specified properties. Properties that you do not specify retain their default values.

Properties

AnalyzedResult	Computed S-parameters, noise figure, OIP ₃ , and group delay values
C	Capacitance data
L	Inductance data
Name	Object name
nPort	Number of ports

Methods

Examples

```
filter = rfckt.lcbandstoptee...
        ('C',[1e-12 4e-12], 'L',[2e-9 2.5e-9])
```

```
filter =
```

```
    Name: 'LC Bandstop Tee'
    nPort: 2
    AnalyzedResult: []
    L: [2x1 double]
    C: [2x1 double]
```

References

Ludwig, R. and P. Bretchko, *RF Circuit Design: Theory and Applications*, Prentice-Hall, 2000.

Zverev, A.I., *Handbook of Filter Synthesis*, John Wiley & Sons, 1967.

See Also

```
rfckt.lcbandpasspi | rfckt.lcbandpasstee | rfckt.lcbandstoppi |
rfckt.lchighpasspi | rfckt.lchighpasstee | rfckt.lclowpasspi |
rfckt.lclowpasstee
```

rfckt.lchighpasspi class

Package: rfckt

Highpass pi filter

Syntax

```
h = rfckt.lchighpasspi
h = rfckt.lchighpasspi('Property1',value1,'Property2',value2,...)
```

Description

Use the `lchighpasspi` class to represent a highpass pi filter as a network of inductors and capacitors.

The LC highpass pi network object is a 2-port network as shown in the following circuit diagram.

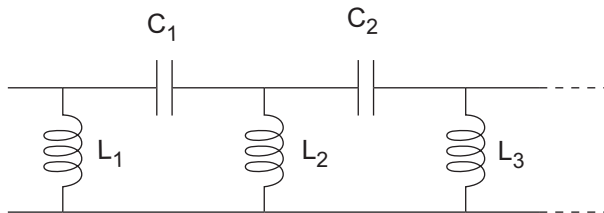

In the diagram, $[L_1, L_2, L_3, \dots]$ is the value of the 'L' object property, and $[C_1, C_2, C_3, \dots]$ is the value of the 'C' object property.

`h = rfckt.lchighpasspi` returns an LC highpass pi network object whose properties all have their default values.

`h = rfckt.lchighpasspi('Property1',value1,'Property2',value2,...)` returns an LC highpass pi network object, `h`, based on the specified properties. Properties that you do not specify retain their default values.

Properties

AnalyzedResult	Computed S-parameters, noise figure, OIP ₃ , and group delay values
C	Capacitance data
L	Inductance data
Name	Object name
nPort	Number of ports

Methods

Examples

```
filter = rfckt.lchighpasspi...
        ('C',[1e-12 4e-12], 'L',[2e-9 2.5e-9])
```

```
filter =
```

```
    Name: 'LC Highpass Pi'
    nPort: 2
    AnalyzedResult: []
    L: [2x1 double]
    C: [2x1 double]
```

References

Ludwig, R. and P. Bretchko, *RF Circuit Design: Theory and Applications*, Prentice-Hall, 2000.

Zverev, A.I., *Handbook of Filter Synthesis*, John Wiley & Sons, 1967.

See Also

```
rfckt.lcbandpasspi | rfckt.lcbandpasstee | rfckt.lcbandstoppi |
rfckt.lcbandstoptee | rfckt.lchighpasstee | rfckt.lclowpasspi |
rfckt.lclowpasstee
```

rfckt.lchighpasstee class

Package: rfckt

Highpass tee filter

Syntax

```
h = rfckt.lchighpasstee
h = rfckt.lchighpasstee('Property1',value1,'Property2',value2,...)
```

Description

Use the `lchighpasstee` class to represent a highpass tee filter as a network of inductors and capacitors.

The LC highpass tee network object is a 2-port network as shown in the following circuit diagram.

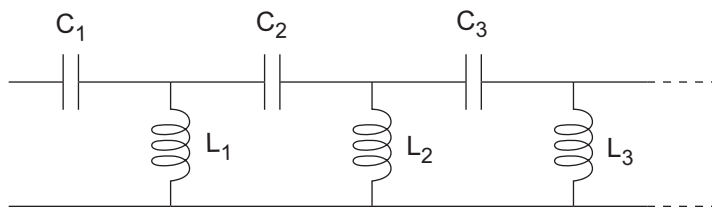

In the diagram, $[L_1, L_2, L_3, \dots]$ is the value of the 'L' object property, and $[C_1, C_2, C_3, \dots]$ is the value of the 'C' object property.

`h = rfckt.lchighpasstee` returns an LC highpass tee network object whose properties all have their default values.

`h = rfckt.lchighpasstee('Property1',value1,'Property2',value2,...)` returns an LC highpass tee network object, `h`, based on the specified properties. Properties that you do not specify retain their default values.

Properties

AnalyzedResult	Computed S-parameters, noise figure, OIP3, and group delay values
C	Capacitance data
L	Inductance data
Name	Object name
nPort	Number of ports

Methods

Examples

```
filter = rfckt.lchighpasstee...
        ('C',[1e-12 4e-12], 'L',[2e-9 2.5e-9])
```

```
filter =
```

```
    Name: 'LC Highpass Tee'
    nPort: 2
    AnalyzedResult: []
    L: [2x1 double]
    C: [2x1 double]
```

References

Ludwig, R. and P. Bretchko, *RF Circuit Design: Theory and Applications*, Prentice-Hall, 2000.

Zverev, A.I., *Handbook of Filter Synthesis*, John Wiley & Sons, 1967.

See Also

```
rfckt.lcbandpasspi | rfckt.lcbandpasstee | rfckt.lcbandstoppi |
rfckt.lcbandstoptee | rfckt.lchighpasspi | rfckt.lclowpasspi |
rfckt.lclowpasstee
```

rfckt.lclowpasspi class

Package: rfckt

Lowpass pi filter

Syntax

```
h = rfckt.lclowpasspi
h = rfckt.lclowpasspi('Property1',value1,'Property2',value2,...)
```

Description

Use the `lclowpasspi` class to represent a lowpass pi filter as a network of inductors and capacitors.

The LC lowpass pi network object is a 2-port network as shown in the following circuit diagram.

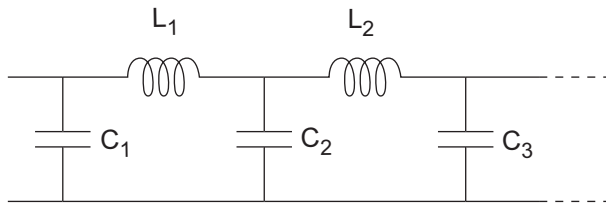

In the diagram, $[L_1, L_2, L_3, \dots]$ is the value of the 'L' object property, and $[C_1, C_2, C_3, \dots]$ is the value of the 'C' object property.

`h = rfckt.lclowpasspi` returns an LC lowpass pi network object whose properties all have their default values.

`h = rfckt.lclowpasspi('Property1',value1,'Property2',value2,...)` returns an LC lowpass pi network object, `h`, based on the specified properties. Properties that you do not specify retain their default values.

Properties

AnalyzedResult	Computed S-parameters, noise figure, OIP3, and group delay values
C	Capacitance data
L	Inductance data
Name	Object name
nPort	Number of ports

Methods

Examples

```
filter = rfckt.lclowpasspi...
        ('C',[1e-12 4e-12], 'L',[2e-9 2.5e-9])
```

```
filter =
```

```
    Name: 'LC Lowpass Pi'
    nPort: 2
    AnalyzedResult: []
    L: [2x1 double]
    C: [2x1 double]
```

References

Ludwig, R. and P. Bretchko, *RF Circuit Design: Theory and Applications*, Prentice-Hall, 2000.

Zverev, A.I., *Handbook of Filter Synthesis*, John Wiley & Sons, 1967.

See Also

rfckt.lcbandpasspi | rfckt.lcbandpasstee | rfckt.lcbandstoppi |
 rfckt.lcbandstoptee | rfckt.lchighpasspi | rfckt.lchighpasstee |
 rfckt.lclowpasstee

rfckt.lclowpasstee class

Package: rfckt

Lowpass tee filter

Syntax

```
h = rfckt.lclowpasstee
h = rfckt.lclowpasstee('Property1',value1,'Property2',value2,...)
```

Description

Use the `lclowpasstee` class to represent a lowpass tee filter as a network of inductors and capacitors.

The LC lowpass tee network object is a 2-port network as shown in the following circuit diagram.

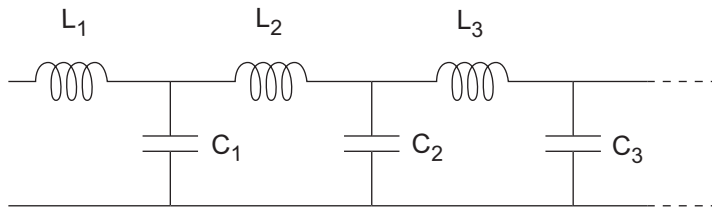

In the diagram, $[L_1, L_2, L_3, \dots]$ is the value of the 'L' object property, and $[C_1, C_2, C_3, \dots]$ is the value of the 'C' object property.

`h = rfckt.lclowpasstee` returns an LC lowpass tee network object whose properties all have their default values.

`h = rfckt.lclowpasstee('Property1',value1,'Property2',value2,...)` returns an LC lowpass tee network object, `h`, based on the specified properties. Properties that you do not specify retain their default values.

Properties

AnalyzedResult	Computed S-parameters, noise figure, OIP3, and group delay values
C	Capacitance data
L	Inductance data
Name	Object name
nPort	Number of ports

Methods

Examples

```
filter = rfckt.lclowpasstee...
        ('C',[1e-12 4e-12], 'L',[2e-9 2.5e-9])
```

```
filter =
```

```
    Name: 'LC Lowpass Tee'
    nPort: 2
    AnalyzedResult: []
    L: [2x1 double]
    C: [2x1 double]
```

References

Ludwig, R. and P. Bretchko, *RF Circuit Design: Theory and Applications*, Prentice-Hall, 2000.

Zverev, A.I., *Handbook of Filter Synthesis*, John Wiley & Sons, 1967.

See Also

```
rfckt.lcbandpasspi | rfckt.lcbandpasstee | rfckt.lcbandstoppi |
rfckt.lcbandstoptee | rfckt.lchighpasspi | rfckt.lchighpasstee |
rfckt.lclowpasspi
```

rfckt.microstrip class

Package: rfckt

Microstrip transmission line

Syntax

```
h = rfckt.microstrip
h = rfckt.microstrip('Property1',value1,'Property2',value2,...)
```

Description

Use the `microstrip` class to represent microstrip transmission lines that are characterized by line dimensions and optional stub properties.

A microstrip transmission line is shown in cross-section in the following figure. Its physical characteristics include the microstrip width (w), the microstrip thickness (t), the substrate height (d), and the relative permittivity constant (ϵ).

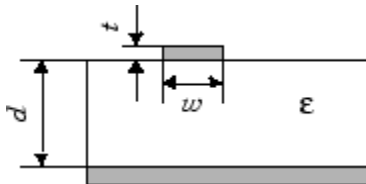

`h = rfckt.microstrip` returns a microstrip transmission line object whose properties are set to their default values.

`h = rfckt.microstrip('Property1',value1,'Property2',value2,...)` returns a microstrip transmission line object, `h`, with the specified properties. Properties that you do not specify retain their default values.

Properties

AnalyzedResult

Computed S-parameters, noise figure, OIP3, and group delay values

EpsilonR	Relative permittivity of dielectric
Height	Dielectric thickness
LineLength	Microstrip line length
LossTangent	Tangent of loss angle
Name	Object name
SigmaCond	Conductor conductivity
StubMode	Type of stub
Termination	Stub transmission line termination
Thickness	Microstrip thickness
Width	Parallel-plate width
nPort	Number of ports

Methods

Examples

```
tx1=rfckt.microstrip('Thickness',0.0075e-6)
```

```
tx1 =
```

```
Name: 'Microstrip Transmission Line'  
nPort: 2  
AnalyzedResult: []  
LineLength: 0.0100  
StubMode: 'NotAStub'  
Termination: 'NotApplicable'  
Width: 6.0000e-004  
Height: 6.3500e-004  
Thickness: 7.5000e-009  
EpsilonR: 9.8000  
SigmaCond: Inf  
LossTangent: 0
```

References

[1] Gupta, K. C., R. Garg, I. Bahl, and P. Bhartia, *Microstrip Lines and Slotlines*, 2nd Edition, Artech House, Inc., Norwood, MA, 1996.

See Also

`rfckt.coaxial` | `rfckt.cpw` | `rfckt.parallelplate` | `rfckt.rlcgline` |
`rfckt.twowire` | `rfckt.txline`

rfckt.mixer class

Package: rfckt

2-port representation of RF mixer and its local oscillator

Syntax

```
h = rfckt.mixer
h = rfckt.mixer('Property1',value1,'Property2',value2,...)
```

Description

Use the `mixer` class to represent RF mixers and their local oscillators that are characterized by network parameters, noise data, nonlinearity data, and local oscillator frequency.

`h = rfckt.mixer` returns a mixer object whose properties all have their default values.

`h = rfckt.mixer('Property1',value1,'Property2',value2,...)` returns a circuit object, `h`, that represents a mixer and its local oscillator (LO) with two ports (RF and IF). Properties that you do not specify retain their default values.

Use the `read` method to read the mixer data from a data file in one of the following formats:

- Touchstone
- Agilent P2D
- Agilent S2D
- AMP

See for information about the `.amp` format.

Note: If you set `NonLinearData` using `rfdata.ip3` or `rfdata.power`, then the property is converted from scalar OIP3 format to the format of `rfdata.ip3` or `rfdata.power`.

Properties

AnalyzedResult	Computed S-parameters, noise figure, OIP3, and group delay values
FLO	Local oscillator frequency
FreqOffset	Frequency offset data
IntpType	Interpolation method
MixerSpurData	Data from mixer spur table
MixerType	Type of mixer
Name	Object name
NetworkData	Network parameter information
NoiseData	Noise information
NonlinearData	Nonlinearity information
PhaseNoiseLevel	Phase noise data
nPort	Number of ports

Methods

Examples

```
mix1 = rfckt.mixer('IntpType','cubic')
```

```
mix1 =
```

```
    Name: 'Mixer'  
    nPort: 2  
    AnalyzedResult: [1x1 rfdata.data]  
    IntpType: 'Cubic'  
    NetworkData: [1x1 rfdata.network]  
    NoiseData: [1x1 rfdata.noise]  
    NonlinearData: Inf  
    MixerSpurData: []  
    MixerType: 'Downconverter'  
    FLO: 1.0000e+009
```

FreqOffset: []
PhaseNoiseLevel: []

References

EIA/IBIS Open Forum, *Touchstone File Format Specification*, Rev. 1.1, 2002 (http://www.vhdl.org/pub/ibis/connector/touchstone_spec11.pdf).

See Also

rfckt.amplifier | rfckt.datafile | rfckt.passive | rfdata.data |
rfdata.ip3 | rfdata.mixerspur | rfdata.network | rfdata.nf | rfdata.noise
| rfdata.power | http://www.vhdl.org/pub/ibis/connector/touchstone_spec11.pdf

rfckt.parallel class

Package: rfckt

Parallel connected network

Syntax

```
h = rfckt.parallel
h = rfckt.parallel('Property1',value1,'Property2',value2,...)
```

Description

Use the `parallel` class to represent networks of linear RF objects connected in parallel that are characterized by the components that make up the network. The following figure shows a pair of networks in a parallel configuration.

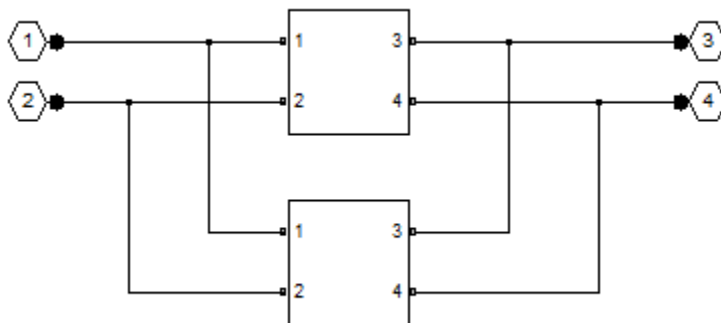

`h = rfckt.parallel` returns a parallel connected network object whose properties all have their default values.

`h = rfckt.parallel('Property1',value1,'Property2',value2,...)` returns a parallel connected network object, `h`, based on the specified properties. Properties that you do not specify retain their default values.

Properties

AnalyzedResult	Computed S-parameters, noise figure, OIP3, and group delay values
Ckts	Circuit objects in network
Name	Object name
nPort	Number of ports

Methods

Examples

```
tx1 = rfckt.txline;  
tx2 = rfckt.txline;  
pl1 = rfckt.parallel('Ckts',{tx1,tx2})
```

```
pl1 =
```

```
Name: 'Parallel Connected Network'  
nPort: 2  
AnalyzedResult: []  
Ckts: {1x2 cell}
```

References

Ludwig, R. and P. Bretchko, *RF Circuit Design: Theory and Applications*, Prentice-Hall, 2000.

See Also

rfckt.cascade | rfckt.hybrid | rfckt.hybridg | rfckt.series

rfckt.parallelplate class

Package: rfckt

Parallel-plate transmission line

Syntax

```
h = rfckt.parallelplate
h = rfckt.parallelplate('Property1',value1,'Property2',value2,...)
```

Description

Use the `parallelplate` class to represent parallel-plate transmission lines that are characterized by line dimensions and optional stub properties.

A parallel-plate transmission line is shown in cross-section in the following figure. Its physical characteristics include the plate width w and the plate separation d .

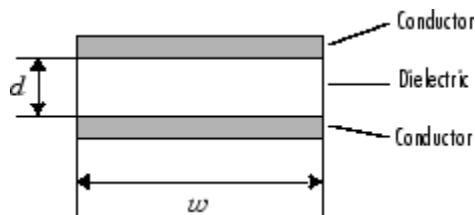

`h = rfckt.parallelplate` returns a parallel-plate transmission line object whose properties are set to their default values.

`h = rfckt.parallelplate('Property1',value1,'Property2',value2,...)` returns a parallel-plate transmission line object, `h`, with the specified properties. Properties that you do not specify retain their default values.

Properties

AnalyzedResult

Computed S-parameters, noise figure, OIP₃, and group delay values

EpsilonR	Relative permittivity of dielectric
LineLength	Parallel-plate line length
LossTangent	Tangent of loss angle
MuR	Relative permeability of dielectric
Name	Object name
Separation	Distance between plates
SigmaCond	Conductor conductivity
StubMode	Type of stub
Termination	Stub transmission line termination
Width	Transmission line width
nPort	Number of ports

Methods

Examples

```
tx1=rfckt.parallelplate('LineLength',0.045)
```

```
tx1 =
```

```
Name: 'Parallel-Plate Transmission Line'
nPort: 2
AnalyzedResult: []
LineLength: 0.0450
StubMode: 'NotAStub'
Termination: 'NotApplicable'
Width: 0.0050
Separation: 1.0000e-003
MuR: 1
EpsilonR: 2.3000
LossTangent: 0
SigmaCond: Inf
```

References

Pozar, David M. *Microwave Engineering*, John Wiley & Sons, Inc., 2005.

See Also

rfckt.coaxial | rfckt.cpw | rfckt.microstrip | rfckt.rlcgline |
rfckt.twowire | rfckt.txline

rfckt.passive class

Package: rfckt

Passive component or network

Syntax

```
h = rfckt.passive
h = rfckt.passive('Property1',value1,'Property2',value2,...)
```

Description

Use the `passive` class to represent passive RF components and networks that are characterized by passive network parameter data.

`h = rfckt.passive` returns an passive-device object whose properties all have their default values.

`h = rfckt.passive('Property1',value1,'Property2',value2,...)` returns a circuit object, `h`, based on the specified properties. Properties that you do not specify retain their default values.

Use the `read` method to read the passive object data from a Touchstone data file. When you read S-parameter data into an `rfckt.passive` object, the magnitude of your S_{21} data must be less than or equal to 1.

Due to random numerical error, data measured from a passive device is not necessarily passive. However, `rfckt.passive` objects can only contain passive data. To import data with active regions, use the `rfckt.amplifier` object, even if the original data represents a passive device.

Properties

AnalyzedResult

Computed S-parameters, noise figure, OIP3, and group delay values

IntpType	Interpolation method
Name	Object name
NetworkData	Network parameter information
nPort	Number of ports

Methods

Examples

```
pas = rfckt.passive('IntpType','cubic')
```

```
pas =
```

```
    Name: 'Passive'  
    nPort: 2  
    AnalyzedResult: [1x1 rfddata.data]  
    IntpType: 'Cubic'  
    NetworkData: [1x1 rfddata.network]
```

References

EIA/IBIS Open Forum, *Touchstone File Format Specification*, Rev. 1.1, 2002 (http://www.vhdl.org/pub/ibis/connector/touchstone_spec11.pdf).

See Also

[rfckt.amplifier](#) | [rfckt.datafile](#) | [rfckt.mixer](#) | [rfddata.data](#) | [rfddata.network](#) | http://www.vhdl.org/pub/ibis/connector/touchstone_spec11.pdf

rfckt.rlcgline class

Package: rfckt

RLCG transmission line

Syntax

```
h = rfckt.rlcgline
h = rfckt.rlcgline('Property1',value1,'Property2',value2,...)
```

Description

Use the `rlcgline` class to represent RLCG transmission lines that are characterized by line loss, line length, stub type, and termination.

`h = rfckt.rlcgline` returns an RLCG transmission line object whose properties are set to their default values.

`h = rfckt.rlcgline('Property1',value1,'Property2',value2,...)` returns an RLCG transmission line object, `h`, with the specified properties. Properties that you do not specify retain their default values.

Properties

AnalyzedResult	Computed S-parameters, noise figure, OIP3, and group delay values
C	Capacitance data
Freq	Frequency data
G	Conductance data
IntpType	Interpolation method
L	Inductance data
LineLength	Transmission line length
Name	Object name

R	Resistance data
StubMode	Type of stub
Termination	Stub transmission line termination
nPort	Number of ports

Methods

Examples

```
tx1=rfckt.rlcgline('R',0.002,'C',8.8542e-12,...  
                  'L',1.2566e-6,'G',0.002')
```

```
tx1 =
```

```
      Name: 'RLCG Transmission Line'  
      nPort: 2  
      AnalyzedResult: []  
      LineLength: 0.0100  
      StubMode: 'NotAStub'  
      Termination: 'NotApplicable'  
      Freq: 1.0000e+009  
      R: 0.0020  
      L: 1.2566e-006  
      C: 8.8542e-012  
      G: 0.0020  
      IntpType: 'Linear'
```

References

Ludwig, R. and P. Bretchko, *RF Circuit Design: Theory and Applications*, Prentice-Hall, 2000.

See Also

[rfckt.coaxial](#) | [rfckt.cpw](#) | [rfckt.microstrip](#) | [rfckt.parallelplate](#) | [rfckt.twowire](#) | [rfckt.txline](#)

rfckt.series class

Package: rfckt

Series connected network

Syntax

```
h = rfckt.series
h = rfckt.series('Property1',value1,'Property2',value2,...)
```

Description

Use the `series` class to represent networks of linear RF objects connected in series that are characterized by the components that make up the network. The following figure shows a pair of networks in a series configuration.

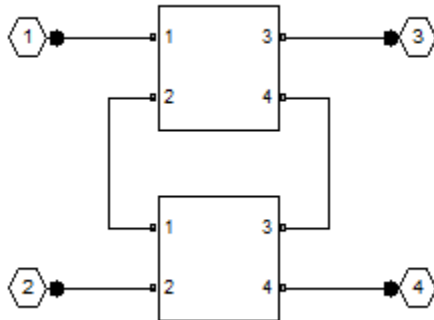

`h = rfckt.series` returns a series connected network object whose properties all have their default values.

`h = rfckt.series('Property1',value1,'Property2',value2,...)` returns a series connected network object, `h`, based on the specified properties. Properties that you do not specify retain their default values.

Properties

AnalyzedResult	Computed S-parameters, noise figure, OIP3, and group delay values
Ckts	Circuit objects in network
Name	Object name
nPort	Number of ports

Methods

Examples

```
tx1 = rfckt.txline;  
tx2 = rfckt.txline;  
ser = rfckt.series('Ckts',{tx1,tx2})
```

```
ser =
```

```
      Name: 'Series Connected Network'  
      nPort: 2  
      AnalyzedResult: []  
      Ckts: {1x2 cell}
```

References

Ludwig, Reinhold and Pavel Bretchko, *RF Circuit Design: Theory and Applications*, Prentice-Hall, 2000.

See Also

[rfckt.cascade](#) | [rfckt.hybrid](#) | [rfckt.hybridg](#) | [rfckt.parallel](#)

rfckt.seriesrlc class

Package: rfckt

Series RLC component

Syntax

```
h = rfckt.seriesrlc
h = rfckt.seriesrlc('R',Rvalue,'L',Lvalue,'C',Cvalue)
```

Description

Use the `seriesrlc` class to represent a component as a resistor, inductor, and capacitor connected in series.

The series RLC network object is a 2-port network as shown in the following circuit diagram.

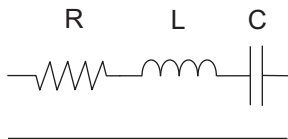

`h = rfckt.seriesrlc` returns a series RLC network object whose properties all have their default values. The default object is equivalent to a pass-through 2-port network, i.e., the resistor, inductor, and capacitor are each replaced by a short circuit.

`h = rfckt.seriesrlc('R',Rvalue,'L',Lvalue,'C',Cvalue)` returns a series RLC network object, `h`, based on the specified resistance (R), inductance (L), and capacitance (C) values. Properties that you do not specify retain their default values, allowing you to specify a network of a single resistor, inductor, or capacitor.

Properties

AnalyzedResult

Computed S-parameters, noise figure, OIP3, and group delay values

C	Capacitance value
L	Inductance value
Name	Object name
R	Resistance value
nPort	Number of ports

Methods

Examples

Frequency Response of an LC Resonator

This example creates a series LC resonator and examines its frequency response. It first creates the circuit object and then uses the analyze method to calculate its frequency response. Finally, it plots the results - first, the magnitude in decibels (dB):

```
h = rfckt.seriesrlc('L',4.7e-5,'C',2.2e-10);  
analyze(h,logspace(4,8,1000));  
plot(h,'s21','dB')  
ax = gca;  
ax.XScale = 'log';
```

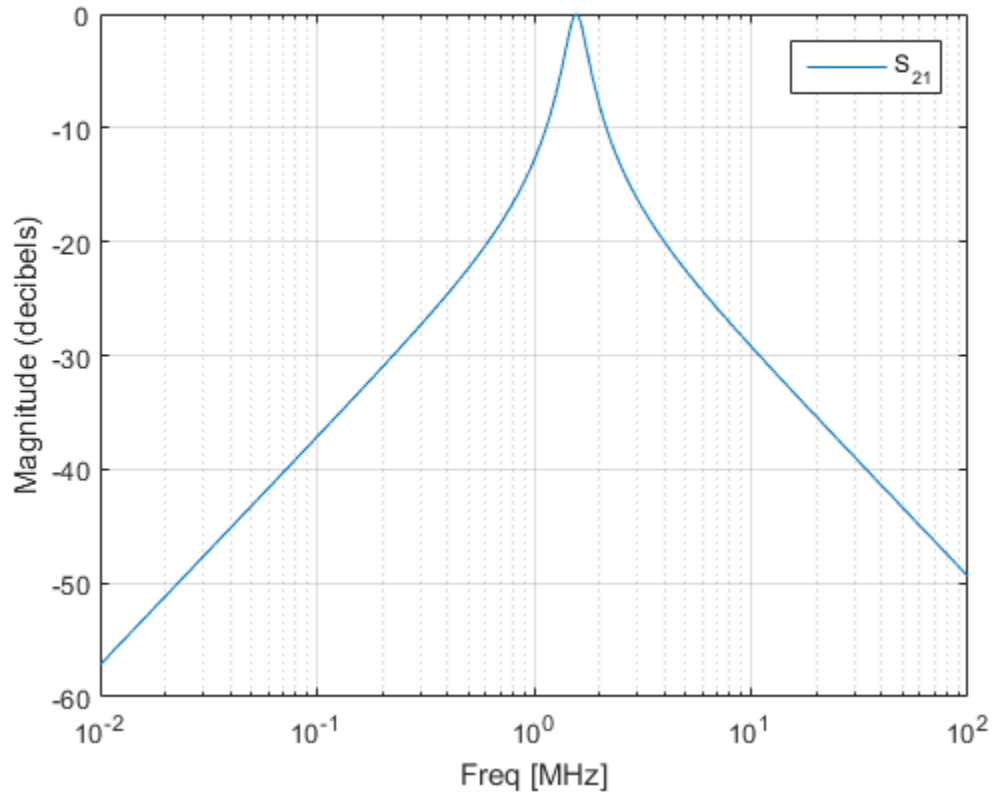
The example then plots the phase, in degrees:

```
figure
plot(h, 's21', 'angle')
ax = gca;
ax.XScale = 'log';
```

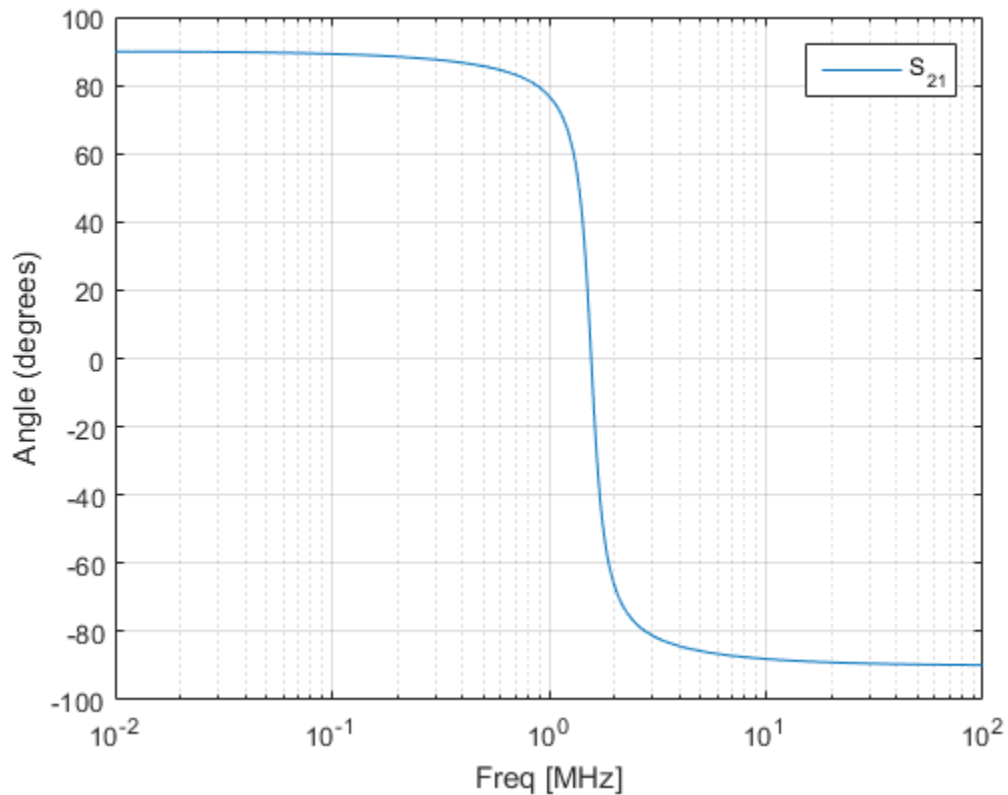

References

Ludwig, Reinhold and Pavel Bretchko, *RF Circuit Design: Theory and Applications*, Prentice-Hall, 2000.

See Also

rfckt.shuntrlc

rfckt.shuntrlc class

Package: rfckt

Shunt RLC component

Syntax

```
h = rfckt.shuntrlc
h = rfckt.shuntrlc('R',Rvalue,'L',Lvalue,'C',Cvalue)
```

Description

Use the `shuntrlc` class to represent a component as a resistor, inductor, and capacitor connected in a shunt configuration.

The shunt RLC network object is a 2-port network as shown in the following circuit diagram.

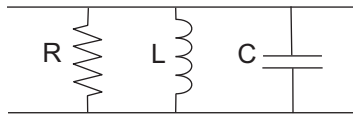

`h = rfckt.shuntrlc` returns a shunt RLC network object whose properties all have their default values. The default object is equivalent to a pass-through 2-port network; i.e., the resistor, inductor, and capacitor are each replaced by a short circuit.

`h = rfckt.shuntrlc('R',Rvalue,'L',Lvalue,'C',Cvalue)` returns a shunt RLC network object, `h`, based on the specified resistance (`R`), inductance (`L`), and capacitance (`C`) values. Properties that you do not specify retain their default values, allowing you to specify a network of a single resistor, inductor, or capacitor.

Properties

AnalyzedResult

Computed S-parameters, noise figure, OIP3, and group delay values

C	Capacitance value
L	Inductance value
Name	Object name
R	Resistance value
nPort	Number of ports

Methods

Examples

Frequency Response of a Shunt LC Resonator

This example creates a shunt LC resonator and examines its frequency response. It first creates the circuit object and then uses the analyze method to calculate its frequency response. The plot is in decibels(dB).

```
h = rfckt.shuntrlc('L',4.7e-5,'C',2.2e-10);  
analyze(h,logspace(4,8,1000));  
plot(h,'s21','dB')  
ax = gca;  
ax.XScale = 'log';
```

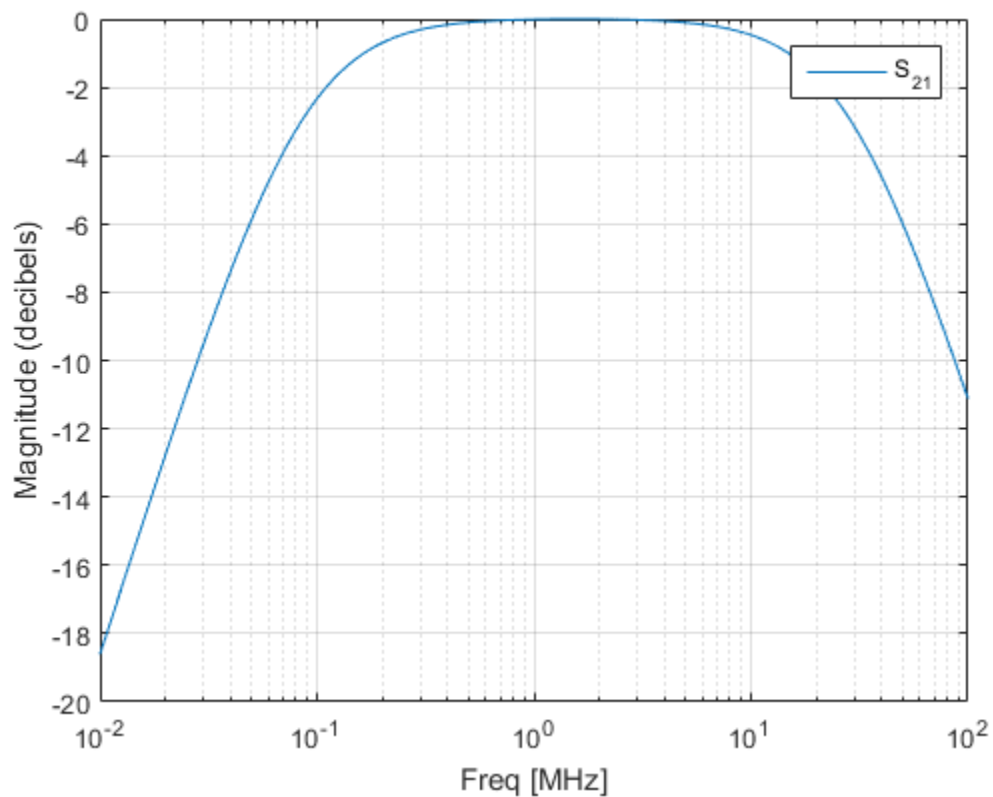

The example then plots the phase, in degrees:

```
figure
plot(h, 's21', 'angle')
ax = gca;
ax.XScale = 'log';
```

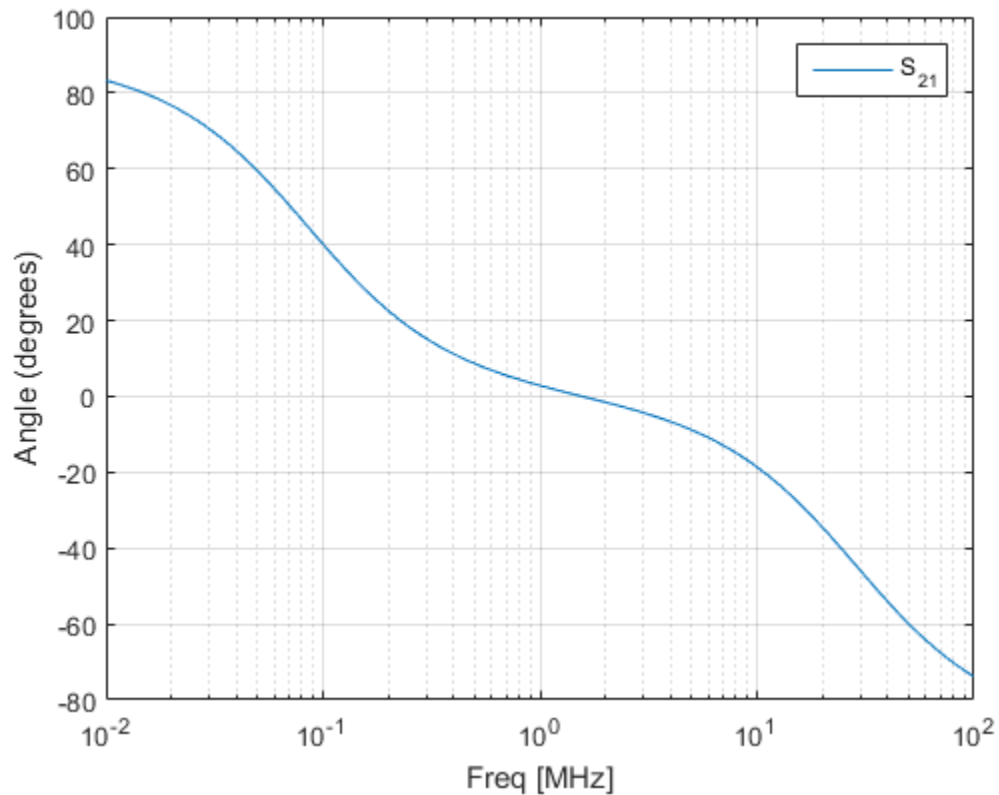

References

Ludwig, Reinhold and Pavel Bretchko, *RF Circuit Design: Theory and Applications*, Prentice-Hall, 2000.

See Also

rfckt.seriesrlc

rfckt.twowire class

Package: rfckt

Two-wire transmission line

Syntax

```
h = rfckt.twowire  
h = rfckt.twowire('Property1',value1,'Property2',value2,...)
```

Description

Use the `twowire` class to represent two-wire transmission lines that are characterized by line dimensions, stub type, and termination.

A two-wire transmission line is shown in cross-section in the following figure. Its physical characteristics include the radius of the wires a , the separation or physical distance between the wire centers S , and the relative permittivity and permeability of the wires. RF Toolbox software assumes the relative permittivity and permeability are uniform.

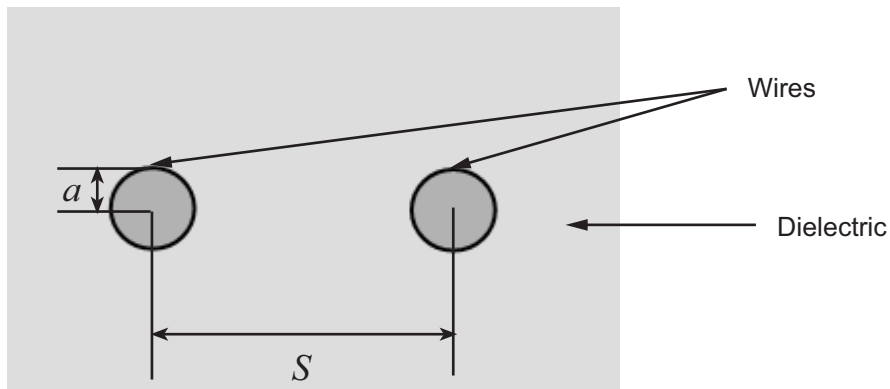

`h = rfckt.twowire` returns a two-wire transmission line object whose properties are set to their default values.

`h = rfckt.twowire('Property1',value1,'Property2',value2,...)` returns a two-wire transmission line object, `h`, with the specified properties. Properties that you do not specify retain their default values.

Construction

Properties

AnalyzedResult	Computed S-parameters, noise figure, OIP3, and group delay values
EpsilonR	Relative permittivity of dielectric
LineLength	Transmission line length
LossTangent	Tangent of loss angle
MuR	Relative permeability of dielectric
Name	Object name
Radius	Wire radius
Separation	Distance between wires
SigmaCond	Conductor conductivity
StubMode	Type of stub
Termination	Stub transmission line termination
nPort	Number of ports

Methods

Examples

```
tx1=rfckt.twowire('Radius',7.5e-4)
```

```
tx1 =
```

```
      Name: 'Two-Wire Transmission Line'
```



```
nPort: 2
AnalyzedResult: []
LineLength: 0.0100
StubMode: 'NotAStub'
Termination: 'NotApplicable'
Radius: 7.5000e-004
Separation: 0.0016
MuR: 1
EpsilonR: 2.3000
LossTangent: 0
SigmaCond: Inf
```

References

Pozar, David M. *Microwave Engineering*, John Wiley & Sons, Inc., 2005.

See Also

`rfckt.coaxial` | `rfckt.cpw` | `rfckt.microstrip` | `rfckt.parallelplate` |
`rfckt.rlcgline` | `rfckt.txline`

rfckt.txline class

Package: rfckt

General transmission line

Syntax

```
h = rfckt.txline
h = rfckt.txline('Property1',value1,'Property2',value2,...)
```

Description

Use the `txline` class to represent transmission lines that are characterized by line loss, line length, stub type, and termination.

`h = rfckt.txline` returns a transmission line object whose properties are set to their default values.

`h = rfckt.txline('Property1',value1,'Property2',value2,...)` returns a transmission line object, `h`, with the specified properties. Properties that you do not specify retain their default values.

Properties

AnalyzedResult	Computed S-parameters, noise figure, OIP3, and group delay values
Freq	Frequency data
IntpType	Interpolation method
LineLength	Transmission line length
Loss	Transmission line loss
Name	Object name
PV	Phase velocity

StubMode	Type of stub
Termination	Stub transmission line termination
Z0	Characteristic impedance
nPort	Number of ports

Methods

Examples

Frequency Domain Analysis of a Transmission Line

Transmission Line Properties

```
trl = rfckt.txline('Z0',75)
```

```
trl =
```

```
    rfckt.txline with properties:
```

```

        LineLength: 0.0100
        StubMode: 'NotAStub'
    Termination: 'NotApplicable'
            Freq: 1.0000e+09
            Z0: 75
            PV: 299792458
            Loss: 0
        IntpType: 'Linear'
            nPort: 2
    AnalyzedResult: []
            Name: 'Transmission Line'
```

Plot

```

f = [1e9:1.0e7:3e9]; % Simulation frequencies
analyze(trl,f); % Do frequency domain analysis
figure
plot(trl,'s21','angle'); % Plot angle of S21
```

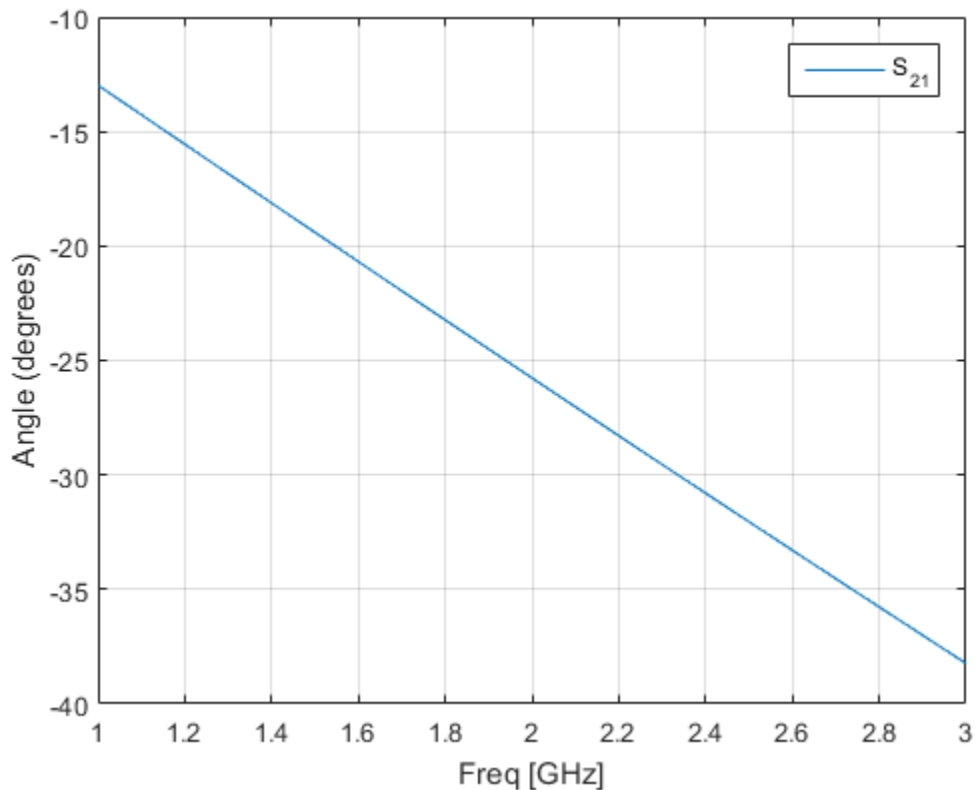

References

Ludwig, R. and P. Bretchko, *RF Circuit Design: Theory and Applications*, Prentice-Hall, 2000.

See Also

`rfckt.coaxial` | `rfckt.cpw` | `rfckt.microstrip` | `rfckt.parallelplate` |
`rfckt.rlcgline` | `rfckt.twowire`

rfdata.data class

Package: rfdata

Store result of circuit object analysis

Syntax

```
h = rfdata.data
h = rfdata.data('Property1',value1,'Property2',value2,...)
```

Description

Use the `data` class to store S-parameters, noise figure in decibels, and frequency-dependent, third-order output (OIP3) intercept points.

There are three ways to create an `rfdata.data` object:

- You can construct it by specifying its properties from workspace data using the `rfdata.data` constructor.
- You can create it from file data using the `read` method.
- You can perform frequency domain analysis of a circuit object using the `analyze` method, and RF Toolbox software stores the results in an `rfdata.data` object.

`h = rfdata.data` returns a data object whose properties all have their default values.

`h = rfdata.data('Property1',value1,'Property2',value2,...)` returns a data object, `h`, based on the specified properties. Properties that you do not specify retain their default values.

Use the `read` method to read data from a file.

Properties

Freq

Frequency data

GroupDelay	Group delay data
IntpType	Interpolation method
NF	Noise figure
Name	Object name
OIP3	Output third-order intercept point
S_Parameters	S-parameter data
Z0	Reference impedance
ZL	Load impedance
ZS	Source impedance

Methods

Examples

RF Data Object From a .s2p Data File

```
file = 'default.s2p';  
h = read(rfdata.data,file); % Read file into data object.  
figure  
plot(h,'s21','db'); % Plot dB(S21) in XY plane.
```

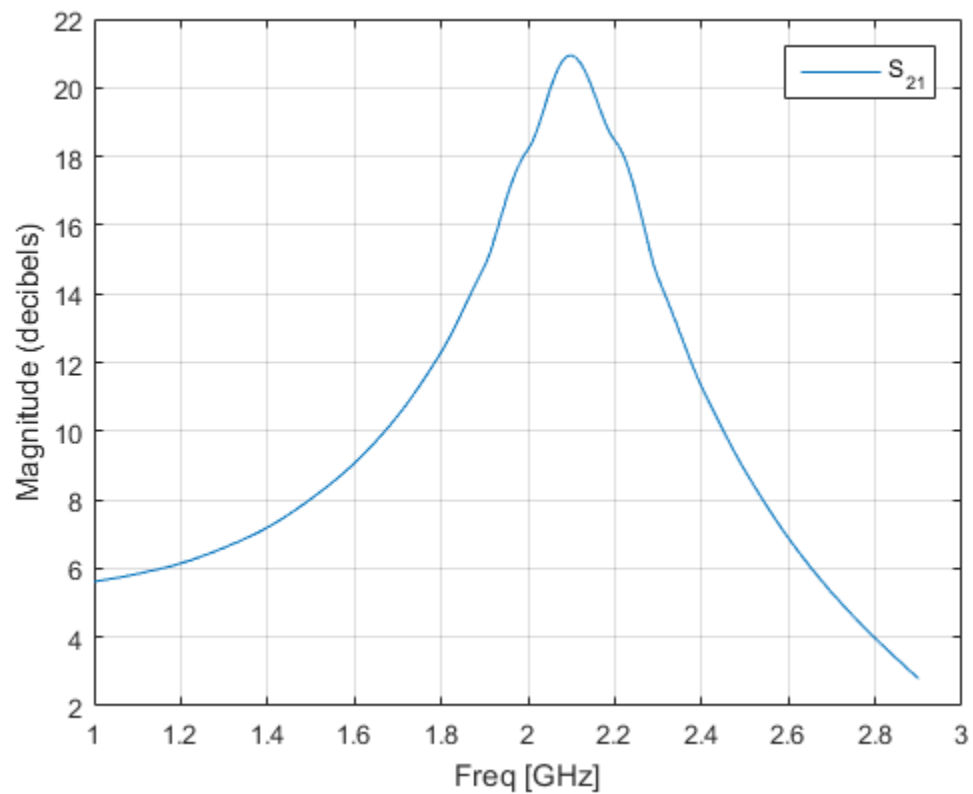

See Also

`rfdata.ip3` | `rfdata.mixerspur` | `rfdata.network` | `rfdata.nf` | `rfdata.noise`
| `rfdata.power`

rfdata.ip3 class

Package: rfdata

Store frequency-dependent, third-order intercept points

Syntax

```
h = rfdata.ip3
h = rfdata.ip3('Type',value1,'Freq',value2,'Data',value3)
```

Description

Use the ip3 class to store third-order intercept point specifications for a circuit object.

`h = rfdata.ip3` returns a data object for the frequency-dependent IP3, `h`, whose properties all have their default values.

`h = rfdata.ip3('Type',value1,'Freq',value2,'Data',value3)` returns a data object for the frequency-dependent IP3, `h`, based on the specified properties.

Note: If you set `NonLinearData` using `rfdata.ip3` or `rfdata.power`, then the property is converted from scalar OIP3 format to the format of `rfdata.ip3` or `rfdata.power`.

Properties

Data	Third-order intercept values
Freq	Frequency data
Name	Object name
Type	Power reference type

Examples

```
ip3data = rfdata.ip3...
```



```
('Type', 'OIP3', 'Freq', 2.1e9, 'Data', 8.45)
```

```
ip3data =
```

```
  Name: '3rd order intercept'
```

```
  Type: 'OIP3'
```

```
  Freq: 2.1000e+009
```

```
  Data: 8.4500
```

See Also

[rfddata.data](#) | [rfddata.mixerspur](#) | [rfddata.network](#) | [rfddata.nf](#) |
[rfddata.noise](#) | [rfddata.power](#)

rfdata.mixerspurs class

Package: rfdata

Store data from intermodulation table

Syntax

```
h = rfdata.mixerspurs
h = rfdata.mixerspurs('Data',value1,'PLORef',value2,'PinRef',value3)
```

Description

Use the `mixerspurs` class to store mixer spur power specifications for a circuit object.

`h = rfdata.mixerspurs` returns a data object that defines an intermodulation table, `h`, whose properties all have their default values.

`h = rfdata.mixerspurs('Data',value1,'PLORef',value2,'PinRef',value3)` returns a data object that defines an intermodulation table, `h`, based on the specified properties.

Properties

Data	Mixer spur power values
Name	Object name
PLORef	Reference local oscillator power
PinRef	Reference input power

Examples

```
spurs = rfdata.mixerspurs...
    ('Data',[2 5 3; 1 0 99; 10 99 99],...
    'PinRef',3,'PLORef',5)
```

```
spurs =  
    Name: 'Intermodulation table'  
    PLORef: 5  
    PinRef: 3  
    Data: [3x3 double]
```

See Also

Visualizing Mixer Spurs | [rfddata.data](#) | [rfddata.ip3](#) | [rfddata.network](#) | [rfddata.nf](#) | [rfddata.noise](#) | [rfddata.power](#)

rfdata.network class

Package: rfdata

Store frequency-dependent network parameters

Syntax

```
h = rfdata.network
h = rfdata.network('Type',value1,'Freq',value2, 'Data',value3,
'Z0',value4)
```

Description

Use the `network` class to store frequency-dependent S-, Y-, Z-, ABCD-, H-, G-, or T-parameters for a circuit object.

`h = rfdata.network` returns a data object for the frequency-dependent network parameters `h`, whose properties all have their default values.

`h = rfdata.network('Type',value1,'Freq',value2, 'Data',value3, 'Z0',value4)` returns a data object for the frequency-dependent network parameters, `h`, based on the specified properties.

Properties

Data	Network parameter data
Freq	Frequency data
Name	Object name
Type	Type of network parameters.
Z0	Reference impedance

Examples

```
f = [2.08 2.10 2.15]*1.0e9;
```

```
y(:,:,1) = [-.0090-.0104i, .0013+.0018i; ...  
            -.2947+.2961i, .0252+.0075i];  
y(:,:,2) = [-.0086-.0047i, .0014+.0019i; ...  
            -.3047+.3083i, .0251+.0086i];  
y(:,:,3) = [-.0051+.0130i, .0017+.0020i; ...  
            -.3335+.3861i, .0282+.0110i];  
  
net = rfddata.network...  
      ('Type','Y_PARAMETERS','Freq',f,'Data',y)
```

See Also

rfddata.data | rfddata.ip3 | rfddata.mixerspur | rfddata.nf | rfddata.noise |
rfddata.power

rfdata.nf class

Package: rfdata

Store frequency-dependent noise figure data for amplifiers or mixers

Syntax

```
h = rfdata.nf
h = rfdata.nf('Freq',value1,'Data',value2)
```

Description

Use the `nf` class to store noise figure specifications for a circuit object.

`h = rfdata.nf` returns a data object for the frequency-dependent noise figure, `h`, whose properties all have their default values.

`h = rfdata.nf('Freq',value1,'Data',value2)` returns a data object for the frequency-dependent noise figure, `h`, based on the specified properties.

Properties

Data	Noise figure values
Freq	Frequency data
Name	Object name

Examples

```
f = 2.0e9;
nf = 13.3244;

nfdata = rfdata.nf('Freq',f,'Data',nf);
```

See Also

`rfdata.data` | `rfdata.ip3` | `rfdata.mixerspur` | `rfdata.network` |
`rfdata.noise` | `rfdata.power`

rfdata.noise class

Package: rfdata

Store frequency-dependent spot noise data for amplifiers or mixers

Syntax

```
h = rfdata.noise
h = rfdata.noise('Freq',value1,'FMIN',value2,'GAMMAOPT',
value3,'RN',value4)
```

Description

Use the `noise` class to store spot noise specifications for a circuit object.

`h = rfdata.noise` returns a data object for the frequency-dependent spot noise, `h`, whose properties all have their default values.

`h = rfdata.noise('Freq',value1,'FMIN',value2,'GAMMAOPT',value3,'RN',value4)` returns a data object for the frequency-dependent spot noise, `h`, based on the specified properties.

Properties

FMIN	Minimum noise figure data
Freq	Frequency data
GAMMAOPT	Optimum source reflection coefficients
Name	Object name
RN	Equivalent normalized noise resistance data

Examples

```
f = [2.08 2.10]*1.0e9;
```



```
fmin = [12.08 13.40];  
gopt = [0.2484-1.2102j 1.0999-0.9295j];  
rn = [0.26 0.45];  
  
noisedata = rfdata.noise('Freq',f,'FMIN',fmin,...  
                        'GAMMAOPT',gopt,'RN',rn);
```

See Also

rfdata.data | rfdata.mixerspur | rfdata.network | rfdata.nf |
rfdata.power

rfdata.power class

Package: rfdata

Store output power and phase information for amplifiers or mixers

Syntax

```
h = rfdata.power
h = rfdata.power(`property1`,value1,`property2`,value2,...)
```

Description

Use the `power` class to store output power and phase specifications for a circuit object.

`h = rfdata.power` returns a data object for the Pin/Pout power data, `h`, whose properties all have their default values.

`h = rfdata.power(`property1`,value1,`property2`,value2,...)` returns a data object for the Pin/Pout power data, `h`, based on the specified properties.

Properties

Freq	Frequency data
Name	Object name
Phase	Phase shift data
Pin	Input power data
Pout	Output power data

Examples

```
f = [2.08 2.10]*1.0e9;
phase = {[27.1 35.3],[15.4 19.3 21.1]};
```

```
pin = {[0.001 0.002],[0.001 0.005 0.01]};  
pout = {[0.0025 0.0031],[0.0025 0.0028 0.0028]};  
powerdata = rfddata.power;  
powerdata.Freq = f;  
powerdata.Phase = phase;  
powerdata.Pin = pin;  
powerdata.Pout = pout;
```

See Also

rfddata.data | rfddata.ip3 | rfddata.mixerspur | rfddata.network | rfddata.nf
| rfddata.noise

rfmodel.rational class

Package: rfmodel

Rational function object

Syntax

```
h = rfmodel.rational
h = rfmodel.rational('Property1',value1,'Property2',value2,...)
```

Description

Use the `rational` class to represent RF components using a rational function object of the form

$$F(s) = \left(\sum_{k=1}^n \frac{C_k}{s - A_k} + D \right) e^{-st}, \quad s = j2\pi f$$

There are two ways to construct an rational function object:

- You can fit a rational function object to the component data using the `rationalfit` function.
- You can use the `rfmodel.rational` constructor to specify the pole-residue representation of the component directly.

`h = rfmodel.rational` returns a rational function object whose properties are set to their default values.

`h = rfmodel.rational('Property1',value1,'Property2',value2,...)` returns a rational function object, `h`, with the specified properties. Properties that you do not specify retain their default values.

Properties

A

Poles of rational function object

C	Residues of rational function object
D	Frequency response offset
Delay	Frequency response time delay
Name	Object name

Methods

Examples

Fit a Rational Function to Data

Fit a rational function to data from an `rfdata.data` object:

```
S = sparameters('defaultbandpass.s2p');
freq = S.Frequencies;
data = rfparam(S,2,1);
fit = rationalfit(freq,data)
```

```
fit =
```

```
rfmodel.rational with properties:
```

```
    A: [10x1 double]
    C: [10x1 double]
    D: 0
Delay: 0
Name: 'Rational Function'
```

Define, Evaluate and Visualize a Rational Function

- Construct a rational function object, `rat`, with poles at -4 Mrad/s, -3 Grad/s, and -5 Grad/s and residues of 600 Mrad/s, 2 Grad/s and 4 Grad/s.
- Perform frequency-domain analysis from 1.0 MHz to 3.0 GHz.
- Plot the resulting frequency response in decibels on the X-Y plane.

```
rat=rfmodel.rational...  
    ('A',[-5e9,-3e9,-4e6],...  
     'C',[6e8,2e9,4e9]);    % Create model  
f = [1e6:1.0e7:3e9];  
[resp,freq]=freqresp(rat,f); % Compute frequency response  
figure  
plot(freq/1e9,20*log10(abs(resp))); % Plot frequency response  
xlabel('Frequency (GHz)')  
ylabel('Magnitude (dB)')
```

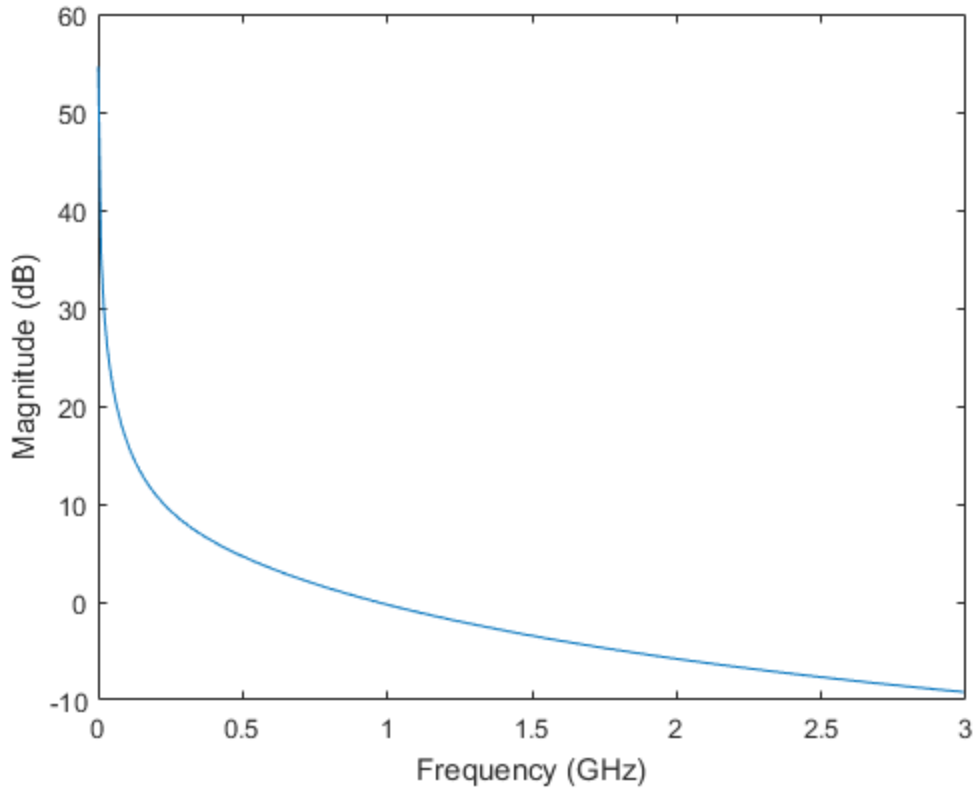

AnalyzedResult property

Class: rfckt.amplifier

Package: rfckt

Computed S-parameters, noise figure, OIP3, and group delay values

Values

rfdata.data object

Description

Handle to an `rfdata.data` object that contains the S-parameters, noise figure, OIP3, and group delay values computed over the specified frequency range using the `analyze` method. The default is a 1-by-1 `rfdata.data` object that contains the S-parameters, noise figure, OIP3, and group delay values that result from analyzing the values stored in the `default.amp` file at the frequencies stored in this file.

The `analyze` method computes the `AnalyzedResult` property using the data stored in the `rfckt.amplifier` object properties as follows:

- The `analyze` method uses the data stored in the 'NoiseData' property of the `rfckt.amplifier` object to calculate the noise figure.
- The `analyze` method uses the data stored in the 'NonlinearData' property of the `rfckt.amplifier` object to calculate OIP3.

If power data exists in the 'NonlinearData' property, the block extracts the AM/AM and AM/PM nonlinearities from the power data.

If the 'NonlinearData' property contains only IP3 data, the method computes and adds the nonlinearity by:

- 1 Using the third-order input intercept point value in dBm to compute the factor, f , that scales the input signal before the amplifier object applies the nonlinearity:

$$F_{AM/AM}(u) = u - \frac{u^3}{3}$$

- 2 Computing the scaled input signal by multiplying the amplifier input signal by f .
- 3 Limiting the scaled input signal to a maximum value of 1.
- 4 Applying an AM/AM conversion to the amplifier gain, according to the following cubic polynomial equation:

$$F_{AM/AM}(u) = u - \frac{u^3}{3}$$

where u is the magnitude of the scaled input signal, which is a unitless normalized input voltage.

- The `analyze` method uses the data stored in the 'NetworkData' property of the `rfckt.amplifier` object to calculate the group delay values of the amplifier at the frequencies specified in `freq`, as described in the `analyze` reference page.
- The `analyze` method uses the data stored in the 'NetworkData' property of the `rfckt.amplifier` object to calculate the S-parameter values of the amplifier at the frequencies specified in `freq`. If the 'NetworkData' property contains network Y- or Z-parameters, the `analyze` method first converts the parameters to S-parameters. Using the interpolation method you specify with the 'IntpType' property, the `analyze` method interpolates the S-parameter values to determine their values at the specified frequencies.

Specifically, the `analyze` method orders the S-parameters according to the ascending order of their frequencies, f_n . It then interpolates the S-parameters, using the MATLAB `interp1` function. For example, the curve in the following diagram illustrates the result of interpolating the S_{11} parameters at five different frequencies.

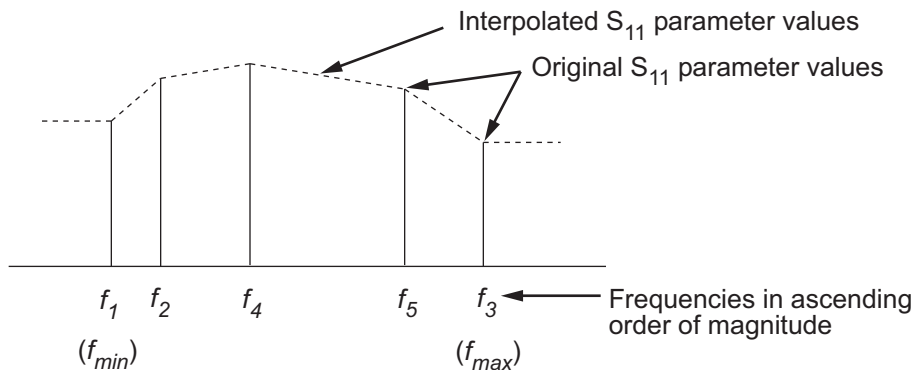

For more information, see “One-Dimensional Interpolation” and the `interp1` reference page in the MATLAB documentation.

As shown in the preceding diagram, the `analyze` method uses the parameter values at f_{min} , the minimum input frequency, for all frequencies smaller than f_{min} . It uses the parameters values at f_{max} , the maximum input frequency, for all frequencies greater than f_{max} . In both cases, the results may not be accurate, so you need to specify network parameter values over a range of frequencies that is wide enough to account for the amplifier behavior.

Examples

```
amp = rfckt.amplifier;  
amp.AnalyzedResult
```

```
ans =
```

```
Name: 'Data object'  
Freq: [191x1 double]  
S_Parameters: [2x2x191 double]  
GroupDelay: [191x1 double]  
NF: [191x1 double]  
OIP3: [191x1 double]  
Z0: 50  
ZS: 50  
ZL: 50  
IntpType: 'Linear'
```

IntpType property

Class: rfckt.amplifier

Package: rfckt

Interpolation method

Values

'Linear' (default), 'Spline', or 'Cubic'

Description

The `analyze` method is flexible in that it does not require the frequencies of the specified S-parameters to match the requested analysis frequencies. If needed, `analyze` applies the interpolation and extrapolation method specified in the `IntpType` property to the specified data to create a new set of data at the requested analysis frequencies. The following table lists the available interpolation methods and describes each one.

Method	Description
Linear (default)	Linear interpolation
Spline	Cubic spline interpolation
Cubic	Piecewise cubic Hermite interpolation

Examples

```
amp = rfckt.amplifier;  
amp.IntpType = 'cubic'
```

```
amp =
```

```
    Name: 'Amplifier'  
    nPort: 2  
    AnalyzedResult: [1x1 rfdata.data]  
    IntpType: 'Cubic'
```

```
NetworkData: [1x1 rfddata.network]  
NoiseData: [1x1 rfddata.noise]  
NonlinearData: [1x1 rfddata.power]
```

Name property

Class: rfckt.amplifier

Package: rfckt

Object name

Values

'Amplifier'

Description

Read-only string that contains the name of the object.

Examples

```
amp = rfckt.amplifier;  
amp.Name
```

```
ans =
```

```
    Amplifier
```

NetworkData property

Class: rfckt.amplifier

Package: rfckt

Network parameter information

Values

rfdata.network object

Description

An rfdata.network object that stores network parameter data. The default network parameter values are taken from the 'default.amp' data file.

Examples

```
amp = rfckt.amplifier;  
amp.NetworkData
```

```
ans =
```

```
    Name: 'Network parameters'  
    Type: 'S_PARAMETERS'  
    Freq: [191x1 double]  
    Data: [2x2x191 double]  
    Z0: 50
```

NoiseData property

Class: rfckt.amplifier

Package: rfckt

Noise information

Values

Scalar noise figure in decibels, `rfdata.noise` object or `rfdata.nf` object

Description

A scalar value or object that stores noise data. The default is an `rfdata.noise` object whose values are taken from the '`default.amp`' data file.

Examples

```
amp = rfckt.amplifier;  
amp.NoiseData
```

```
ans =
```

```
Name: 'Spot noise data'  
Freq: [9x1 double]  
FMIN: [9x1 double]  
GAMMAOPT: [9x1 double]  
RN: [9x1 double]
```

NonlinearData property

Class: rfckt.amplifier

Package: rfckt

Nonlinearity information

Values

Scalar OIP3 in decibels relative to one milliwatt, `rfdata.power` object or `rfdata.ip3` object

Description

A scalar value or object that stores nonlinearity data. The default is an `rfdata.power` object whose values are taken from the `'default.amp'` data file.

Note: If you set `NonLinearData` using `rfdata.ip3` or `rfdata.power`, then the property is converted from scalar OIP3 format to the format of `rfdata.ip3` or `rfdata.power`.

Examples

```
amp = rfckt.amplifier;  
amp.NonlinearData
```

```
ans =
```

```
    Name: 'Power data'  
    Freq: 2.1000e+009  
    Pin: {[20x1 double]}  
    Pout: {[20x1 double]}  
    Phase: {[20x1 double]}
```

nPort property

Class: rfckt.amplifier

Package: rfckt

Number of ports

Values

2

Description

A read-only integer that indicates the object has two ports.

Examples

```
amp = rfckt.amplifier;  
amp.nPort
```

```
ans =
```

```
    2
```

AnalyzedResult property

Class: rfckt.cascade

Package: rfckt

Computed S-parameters, noise figure, OIP3, and group delay values

Values

rfdata.data object

Description

Handle to an `rfdata.data` object that contains the S-parameters, noise figure, OIP3, and group delay values computed over the specified frequency range using the `analyze` method. This property is empty by default.

The `analyze` method computes the `AnalyzedResult` property using the data stored in the `Ckts` property as follows:

- The `analyze` method starts calculating the ABCD-parameters of the cascaded network by converting each component network's parameters to an ABCD-parameters matrix. The figure shows a cascaded network consisting of two 2-port networks, each represented by its ABCD matrix.

The `analyze` method then calculates the ABCD-parameter matrix for the cascaded network by calculating the product of the ABCD matrices of the individual networks.

The following figure shows a cascaded network consisting of two 2-port networks, each represented by its ABCD-parameters.

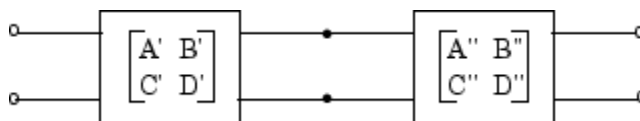

The following equation illustrates calculations of the ABCD-parameters for two 2-port networks.

$$\begin{bmatrix} A & B \\ C & D \end{bmatrix} = \begin{bmatrix} A' & B' \\ C' & D' \end{bmatrix} \begin{bmatrix} A'' & B'' \\ C'' & D'' \end{bmatrix}$$

Finally, `analyze` converts the ABCD-parameters of the cascaded network to S-parameters at the frequencies specified in the `analyze` input argument `freq`.

- The `analyze` method calculates the noise figure for an N-element cascade. First, the method calculates noise correlation matrices $C_{A'}$ and $C_{A''}$, corresponding to the first two matrices in the cascade, using the following equation:

$$C_A = 2kT \begin{bmatrix} R_n & \frac{NF_{\min} - 1}{2} - R_n Y_{opt}^* \\ \frac{NF_{\min} - 1}{2} - R_n Y_{opt} & R_n |Y_{opt}|^2 \end{bmatrix}$$

where k is Boltzmann's constant, and T is the noise temperature in Kelvin.

The method combines $C_{A'}$ and $C_{A''}$ into a single correlation matrix C_A using the equation

$$C_A = C_{A'} + \begin{bmatrix} A' & B' \\ C' & D' \end{bmatrix} C_{A''} \begin{bmatrix} A' & B' \\ C' & D' \end{bmatrix}$$

By applying this equation recursively, the method obtains a noise correlation matrix for the entire cascade. The method then calculates the noise factor, F , from the noise correlation matrix of as follows:

$$F = 1 + \frac{z^+ C_A z}{2kT \operatorname{Re}\{Z_S\}}$$

$$z = \begin{bmatrix} 1 \\ Z_S^* \end{bmatrix}$$

In the two preceding equations, Z_S is the nominal impedance, which is 50 ohms, and z^+ is the Hermitian conjugation of z .

- The `analyze` method calculates the output power at the third-order intercept point (OIP₃) for an N-element cascade using the following equation:

$$OIP_3 = \frac{1}{\frac{1}{OIP_{3,N}} + \frac{1}{G_N \cdot OIP_{3,N-1}} + \dots + \frac{1}{G_N \cdot G_{N-1} \cdot \dots \cdot G_2 \cdot OIP_{3,1}}}$$

where G_n is the gain of the n th element of the cascade and $OIP_{3,N}$ is the OIP₃ of the n th element.

- The `analyze` method uses the cascaded S-parameters to calculate the group delay values at the frequencies specified in the `analyze` input argument `freq`, as described in the `analyze` reference page.

Examples

Analyze a cascade of three circuit objects:

```
amp = rfckt.amplifier('IntpType','cubic');
tx1 = rfckt.txline;
tx2 = rfckt.txline;
casc = rfckt.cascade('Ckts',{tx1,amp,tx2});
analyze(casc,[1e9:1e7:2e9]);
casc.AnalyzedResult
```

References

Hillbrand, H. and P.H. Russer, "An Efficient Method for Computer Aided Noise Analysis of Linear Amplifier Networks," *IEEE Transactions on Circuits and Systems*, Vol. CAS-23, Number 4, pp. 235–238, 1976.

Ckts property

Class: rfckt.cascade

Package: rfckt

Circuit objects in network

Values

Cell

Description

Cell array containing handles to all circuit objects in the network, in order from source to load. All circuits must be 2-port. This property is empty by default.

Examples

```
amp = rfckt.amplifier('IntpType','cubic');  
tx1 = rfckt.txline;  
tx2 = rfckt.txline;  
casc = rfckt.cascade;  
casc.Ckts = {tx1,amp,tx2};  
casc.Ckts
```

```
ans =
```

```
[1x1 rfckt.txline] [1x1 rfckt.amplifier] [1x1 rfckt.txline]
```

Name property

Class: rfckt.cascade

Package: rfckt

Object name

Values

'Cascaded Network'

Description

Read-only string that contains the name of the object.

Examples

```
casc = rfckt.cascade;  
casc.Name
```

```
ans =
```

```
    Cascaded Network
```

nPort property

Class: rfckt.cascade

Package: rfckt

Number of ports

Values

2

Description

A read-only integer that indicates the object has two ports.

Examples

```
casc = rfckt.cascade;  
casc.nPort
```

```
ans =
```

```
2
```

AnalyzedResult property

Class: rfckt.coaxial

Package: rfckt

Computed S-parameters, noise figure, OIP3, and group delay values

Values

`rfdata.data` object

Description

Handle to an `rfdata.data` object that contains the S-parameters, noise figure, OIP3, and group delay values computed over the specified frequency range using the `analyze` method. This property is empty by default.

The `analyze` method treats the transmission line as a 2-port linear network. It computes the `AnalyzedResult` property of a stub or as a stubless line using the data stored in the `rfckt.coaxial` object properties as follows:

- If you model the transmission line as a stubless line, the `analyze` method first calculates the ABCD-parameters at each frequency contained in the modeling frequencies vector. It then uses the `abcd2s` function to convert the ABCD-parameters to S-parameters.

The `analyze` method calculates the ABCD-parameters using the physical length of the transmission line, d , and the complex propagation constant, k , using the following equations:

$$A = \frac{e^{kd} + e^{-kd}}{2}$$

$$B = \frac{Z_0 * (e^{kd} - e^{-kd})}{2}$$

$$C = \frac{e^{kd} - e^{-kd}}{2 * Z_0}$$

$$D = \frac{e^{kd} + e^{-kd}}{2}$$

Z_0 and k are vectors whose elements correspond to the elements of f , the vector of frequencies specified in the `analyze` input argument `freq`. Both can be expressed in terms of the resistance (R), inductance (L), conductance (G), and capacitance (C) per unit length (meters) as follows:

$$Z_0 = \sqrt{\frac{R + j2\pi fL}{G + j2\pi fC}}$$

$$k = k_r + jk_i = \sqrt{(R + j2\pi fL)(G + j2\pi fC)}$$

where

$$R = \frac{1}{2\pi\sigma_{cond}\delta_{cond}} \left(\frac{1}{a} + \frac{1}{b} \right)$$

$$L = \frac{\mu}{2\pi} \ln\left(\frac{b}{a}\right)$$

$$G = \frac{2\pi\omega\epsilon'}{\ln\left(\frac{b}{a}\right)}$$

$$C = \frac{2\pi\epsilon}{\ln\left(\frac{b}{a}\right)}$$

In these equations:

- α is the radius of the inner conductor.
- b is the radius of the outer conductor.
- σ_{cond} is the conductivity in the conductor.
- μ is the permeability of the dielectric.
- ε is the permittivity of the dielectric.
- ε'' is the imaginary part of ε , $\varepsilon'' = \varepsilon_0 \varepsilon_r \tan \delta$, where:
 - ε_0 is the permittivity of free space.
 - ε_r is the `EpsilonR` property value.
 - $\tan \delta$ is the `LossTangent` property value.
- δ_{cond} is the skin depth of the conductor, which the method calculates as $1 / \sqrt{\pi f \mu \sigma_{cond}}$.
- f is a vector of modeling frequencies determined by the `Output` block.
- If you model the transmission line as a shunt or series stub, the `analyze` method first calculates the ABCD-parameters at the specified frequencies. It then uses the `abcd2s` function to convert the ABCD-parameters to S-parameters.

When you set the `StubMode` property to 'Shunt', the 2-port network consists of a stub transmission line that you can terminate with either a short circuit or an open circuit as shown in the following figure.

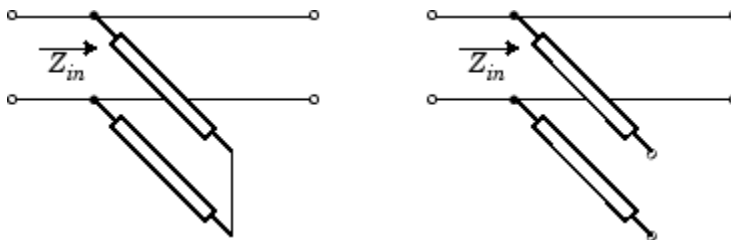

Z_{in} is the input impedance of the shunt circuit. The ABCD-parameters for the shunt stub are calculated as:

$$\begin{aligned}
 A &= 1 \\
 B &= 0 \\
 C &= 1 / Z_{in} \\
 D &= 1
 \end{aligned}$$

When you set the `StubMode` property to 'Series', the 2-port network consists of a series transmission line that you can terminate with either a short circuit or an open circuit as shown in the following figure.

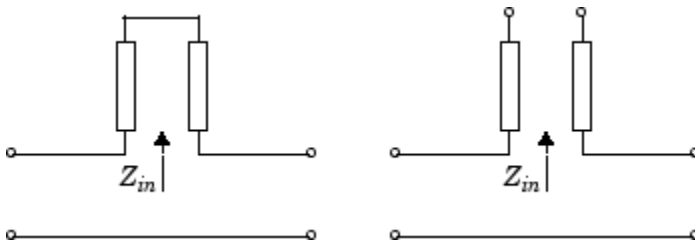

Z_{in} is the input impedance of the series circuit. The ABCD-parameters for the series stub are calculated as

$$\begin{aligned}
 A &= 1 \\
 B &= Z_{in} \\
 C &= 0 \\
 D &= 1
 \end{aligned}$$

The `analyze` method uses the S-parameters to calculate the group delay values at the frequencies specified in the `analyze` input argument `freq`, as described in the `analyze` reference page.

Examples

```
tx1 = rfckt.coaxial;
analyze(tx1,[1e9,2e9,3e9]);
tx1.AnalyzedResult
```

```
ans =
```

Name: 'Data object'
Freq: [3x1 double]
S_Parameters: [2x2x3 double]
GroupDelay: [3x1 double]
NF: [3x1 double]
OIP3: [3x1 double]
Z0: 50
ZS: 50
ZL: 50
IntpType: 'Linear'

EpsilonR property

Class: rfckt.coaxial

Package: rfckt

Relative permittivity of dielectric

Values

Scalar

Description

The ratio of the permittivity of the dielectric, ϵ , to the permittivity of free space, ϵ_0 . The default value is 2.3.

Examples

Change the relative permittivity of the dielectric:

```
tx1=rfckt.coaxial;  
tx1.EpsilonR=2.7;
```

InnerRadius property

Class: rfckt.coaxial

Package: rfckt

Inner conductor radius

Values

Scalar

Description

The radius of the inner conductor, in meters. The default is $7.25e-4$.

Examples

```
tx1=rfckt.coaxial;  
tx1.InnerRadius=2.5e-4;
```

LineLength property

Class: rfckt.coaxial

Package: rfckt

Transmission line length

Values

Scalar

Description

The physical length of the transmission line in meters. The default is 0.01.

Examples

```
tx1 = rfckt.coaxial;  
tx1.LineLength = 0.001;
```

LossTangent property

Class: rfckt.coaxial

Package: rfckt

Tangent of loss angle

Values

Scalar

Description

The loss angle tangent of the dielectric. The default is 0.

Examples

```
tx1=rfckt.coaxial;  
tx1.LossTangent=0.002;
```

MuR property

Class: rfckt.coaxial

Package: rfckt

Relative permeability of dielectric

Values

Scalar

Description

The ratio of the permeability of the dielectric, μ , to the permeability in free space, μ_0 . The default value is 1.

Examples

Change the relative permeability of the dielectric:

```
tx1=rfckt.coaxial;  
tx1.MuR=0.8;
```

Name property

Class: rfckt.coaxial

Package: rfckt

Object name

Values

'Coaxial Transmission Line'

Description

Read-only string that contains the name of the object.

Examples

```
tx1 = rfckt.coaxial;  
tx1.Name
```

```
ans =
```

```
Coaxial Transmission Line
```

OuterRadius property

Class: rfckt.coaxial

Package: rfckt

Outer conductor radius

Values

Scalar

Description

The radius of the outer conductor, in meters. The default is 0.0026.

Examples

```
tx1=rfckt.coaxial;  
tx1.OuterRadius=0.0031;
```

SigmaCond property

Class: rfckt.coaxial

Package: rfckt

Conductor conductivity

Values

Scalar

Description

Conductivity, in Siemens per meter (S/m), of the conductor. The default is Inf.

Examples

```
tx1=rfckt.coaxial;  
tx1.SigmaCond=5.81e7;
```

StubMode property

Class: rfckt.coaxial

Package: rfckt

Type of stub

Values

'NotAStub' (default), 'Series', or 'Shunt'

Description

String that specifies what type of stub, if any, to include in the transmission line model.

Examples

```
tx1 = rfckt.coaxial;  
tx1.StubMode = 'Series';
```

Termination property

Class: rfckt.coaxial

Package: rfckt

Stub transmission line termination

Values

'NotApplicable' (default), 'Open', or 'Short'.

Description

String that specifies what type of termination to use for 'Shunt' and 'Series' stub modes. Termination is ignored if the line has no stub. Use 'NotApplicable' when StubMode is 'NotAStub'.

Examples

```
tx1 = rfckt.coaxial;  
tx1.StubMode = 'Series';  
tx1.Termination = 'Short';
```

nPort property

Class: rfckt.coaxial

Package: rfckt

Number of ports

Values

2

Description

A read-only integer that indicates the object has two ports.

Examples

```
tx1 = rfckt.coaxial;  
tx1.nPort
```

```
ans =
```

```
    2
```

AnalyzedResult property

Class: rfckt.cpw

Package: rfckt

Computed S-parameters, noise figure, OIP3, and group delay values

Values

rfdata.data object

Description

Handle to an `rfdata.data` object that contains the S-parameters, noise figure, OIP3, and group delay values computed over the specified frequency range using the `analyze` method. This property is empty by default.

The `analyze` method treats the transmission line as a 2-port linear network. It computes the `AnalyzedResult` property of a stub or as a stubless line using the data stored in the `rfckt.cpw` object properties as follows:

- If you model the transmission line as a stubless line, the `analyze` method first calculates the ABCD-parameters at each frequency contained in the modeling frequencies vector. It then uses the `abcd2s` function to convert the ABCD-parameters to S-parameters.

The `analyze` method calculates the ABCD-parameters using the physical length of the transmission line, d , and the complex propagation constant, k , using the following equations:

$$A = \frac{e^{kd} + e^{-kd}}{2}$$

$$B = \frac{Z_0 * (e^{kd} - e^{-kd})}{2}$$

$$C = \frac{e^{kd} - e^{-kd}}{2 * Z_0}$$

$$D = \frac{e^{kd} + e^{-kd}}{2}$$

Z_0 and k are vectors whose elements correspond to the elements of f , the vector of frequencies specified in the `analyze` input argument `freq`. Both can be expressed in terms of the specified conductor strip width, slot width, substrate height, conductor strip thickness, relative permittivity constant, conductivity and dielectric loss tangent of the transmission line, as described in [1].

- If you model the transmission line as a shunt or series stub, the `analyze` method first calculates the ABCD-parameters at the specified frequencies. It then uses the `abcd2s` function to convert the ABCD-parameters to S-parameters.

When you set the `StubMode` property to 'Shunt', the 2-port network consists of a stub transmission line that you can terminate with either a short circuit or an open circuit as shown in the following figure.

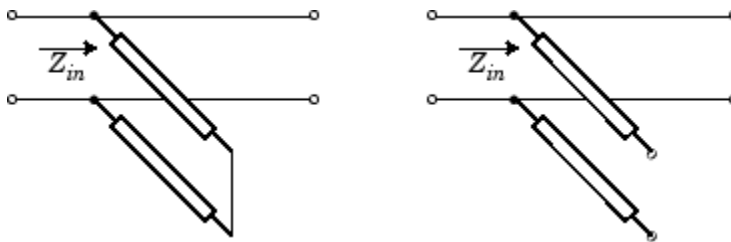

Z_{in} is the input impedance of the shunt circuit. The ABCD-parameters for the shunt stub are calculated as:

$$\begin{aligned}
 A &= 1 \\
 B &= 0 \\
 C &= 1 / Z_{in} \\
 D &= 1
 \end{aligned}$$

When you set the `StubMode` property to 'Series', the 2-port network consists of a series transmission line that you can terminate with either a short circuit or an open circuit as shown in the following figure.

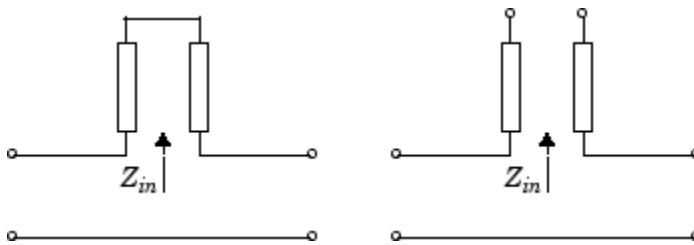

Z_{in} is the input impedance of the series circuit. The ABCD-parameters for the series stub are calculated as:

$$\begin{aligned}
 A &= 1 \\
 B &= Z_{in} \\
 C &= 0 \\
 D &= 1
 \end{aligned}$$

The `analyze` method uses the S-parameters to calculate the group delay values at the frequencies specified in the `analyze` input argument `freq`, as described in the `analyze` reference page.

Examples

```
tx1 = rfckt.cpw;
analyze(tx1,[1e9,2e9,3e9]);
tx1.AnalyzedResult
```

```
ans =
```

```
Name: 'Data object'  
Freq: [3x1 double]  
S_Parameters: [2x2x3 double]  
NF: [3x1 double]  
GroupDelay: [3x1 double]  
OIP3: [3x1 double]  
Z0: 50  
ZS: 50  
ZL: 50  
IntpType: 'Linear'
```

ConductorWidth property

Class: rfckt.cpw

Package: rfckt

Conductor width

Values

Scalar

Description

Physical width, in meters, of the conductor. The default is $0.6e-4$.

Examples

```
tx1=rfckt.cpw;  
tx1.ConductorWidth=0.001;
```

EpsilonR property

Class: rfckt.cpw

Package: rfckt

Relative permittivity of dielectric

Values

Scalar

Description

The ratio of the permittivity of the dielectric, ϵ , to the permittivity of free space, ϵ_0 . The default value is 9.8.

Examples

Change the relative permittivity of the dielectric:

```
tx1=rfckt.cpw;  
tx1.EpsilonR=2.7;
```

Height property

Class: rfckt.cpw

Package: rfckt

Dielectric thickness

Values

Scalar

Description

Physical height, in meters, of the dielectric on which the conductor resides. The default is $0.635e-4$.

Examples

```
tx1=rfckt.cpw;  
tx1.Height=0.001;
```

LineLength property

Class: rfckt.cpw

Package: rfckt

Transmission line length

Values

Scalar

Description

The physical length of the transmission line in meters. The default is 0.01.

Examples

```
tx1 = rfckt.cpw;  
tx1.LineLength = 0.001;
```

LossTangent property

Class: rfckt.cpw

Package: rfckt

Tangent of loss angle

Values

Scalar

Description

The loss angle tangent of the dielectric. The default is 0.

Examples

```
tx1 = rfckt.cpw;  
tx1.LossTangent
```

```
ans =
```

```
0
```

Name property

Class: rfckt.cpw

Package: rfckt

Object name

Values

'Coplanar Waveguide Transmission Line'

Description

Read-only string that contains the name of the object.

Examples

```
tx1 = rfckt.cpw;  
tx1.Name
```

```
ans =
```

```
    Coplanar Waveguide Transmission Line
```

SigmaCond property

Class: rfckt.cpw

Package: rfckt

Conductor conductivity

Values

Scalar

Description

Conductivity, in Siemens per meter (S/m), of the conductor. The default is Inf.

Examples

```
tx1=rfckt.cpw;  
tx1.SigmaCond=5.81e7;
```

SlotWidth property

Class: rfckt.cpw

Package: rfckt

Width of slot

Values

Scalar

Description

Physical width, in meters, of the slot. The default is $0.2e-4$.

Examples

```
tx1=rfckt.cpw;  
tx1.SlotWidth=0.002;
```

StubMode property

Class: rfckt.cpw

Package: rfckt

Type of stub

Values

'NotAStub' (default), 'Series', or 'Shunt'

Description

String that specifies what type of stub, if any, to include in the transmission line model.

Examples

```
tx1 = rfckt.cpw;  
tx1.StubMode = 'Series';
```

Termination property

Class: rfckt.cpw

Package: rfckt

Stub transmission line termination

Values

'NotApplicable' (default), 'Open', or 'Short'.

Description

String that specifies what type of termination to use for 'Shunt' and 'Series' stub modes. `Termination` is ignored if the line has no stub. Use 'NotApplicable' when `StubMode` is 'NotAStub'.

Examples

```
tx1 = rfckt.cpw;  
tx1.StubMode = 'Series';  
tx1.Termination = 'Short';
```

Thickness property

Class: rfckt.cpw

Package: rfckt

Conductor thickness

Values

Scalar

Description

Physical thickness, in meters, of the conductor. The default is $0.005e-6$.

Examples

```
tx1=rfckt.cpw;  
tx1.Thickness=2e-5;
```

nPort property

Class: rfckt.cpw

Package: rfckt

Number of ports

Values

2

Description

A read-only integer that indicates the object has two ports.

Examples

```
tx1 = rfckt.cpw;  
tx1.nPort
```

```
ans =
```

```
2
```

AnalyzedResult property

Class: rfckt.datafile

Package: rfckt

Computed S-parameters, noise figure, OIP3, and group delay values

Values

rfdata.data object

Description

Handle to an `rfdata.data` object that contains the S-parameters, noise figure, OIP3, and group delay values computed over the specified frequency range using the `analyze` method. The default is a 1-by-1 `rfdata.data` object that contains the S-parameters, noise figure, OIP3, and group delay values that are the result of analyzing the values stored in the `passive.s2p` file at the frequencies stored in this file.

The `analyze` method computes the `AnalyzedResult` property using the data stored in the `File` object property. If the file you specify with this property contains network Y- or Z-parameters, `analyze` first converts these parameters, as they exist in the `rfckt.datafile` object, to S-parameters. Using the interpolation method you specify with the `'IntpType'` property, `analyze` interpolates the S-parameters to determine the S-parameters at the specified frequencies. Specifically, `analyze` orders the S-parameters according to the ascending order of their frequencies, f_n . It then interpolates the S-parameters, using the MATLAB `interp1` function. For example, the curve in the following diagram illustrates the result of interpolating the S_{11} parameters at five different frequencies.

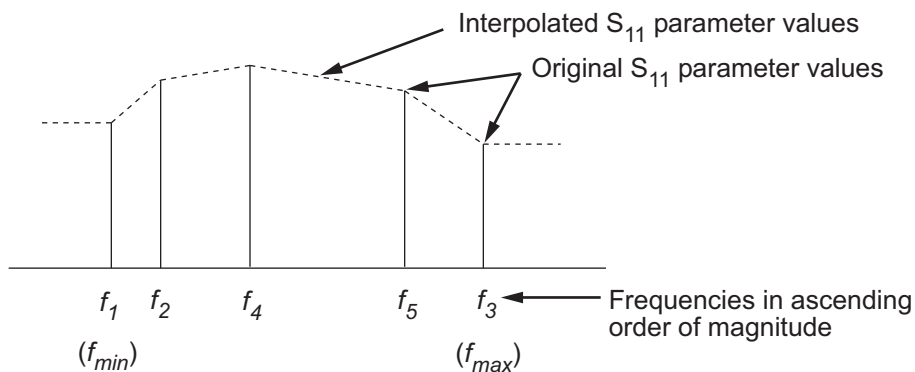

For more information, see “One-Dimensional Interpolation” and the `interp1` reference page in the MATLAB documentation.

As shown in the preceding diagram, the `analyze` method uses the parameter values at f_{min} , the minimum input frequency, for all frequencies smaller than f_{min} . It uses the parameters values at f_{max} , the maximum input frequency, for all frequencies greater than f_{max} . In both cases, the results may not be accurate, so you need to specify network parameter values over a range of frequencies that is wide enough to account for the component behavior.

The `analyze` method uses the S-parameters to calculate the group delay values at the frequencies specified in the `analyze` input argument `freq`, as described in the `analyze` reference page.

Examples

```
data = rfckt.datafile;
data.AnalyzedResult
```

```
ans =
```

```
Name: 'Data object'
Freq: [202x1 double]
S_Parameters: [2x2x202 double]
GroupDelay: [202x1 double]
NF: [202x1 double]
OIP3: [202x1 double]
```

Z0: 50
ZS: 50
ZL: 50
IntpType: 'Linear'

File property

Class: rfckt.datafile

Package: rfckt

File containing circuit data

Values

String

Description

The name of the `.snp`, `.ynp`, `.znp`, or `.hnp` file describing the circuit, where `n` is the number of ports. The default file name is `'passive.s2p'`.

Examples

```
data=rfckt.datafile;  
data.File='default.s2p'
```

```
data =
```

```
    Name: 'Data File'  
    nPort: 2  
    AnalyzedResult: [1x1 rfdata.data]  
    IntpType: 'Linear'  
    File: 'default.s2p'
```

IntpType property

Class: rfckt.datafile

Package: rfckt

Interpolation method

Values

'Linear' (default), 'Spline', or 'Cubic'

Description

The `analyze` method is flexible in that it does not require the frequencies of the specified S-parameters to match the requested analysis frequencies. If needed, `analyze` applies the interpolation and extrapolation method specified in the `IntpType` property to the specified data to create a new set of data at the requested analysis frequencies. The following table lists the available interpolation methods and describes each one.

Method	Description
Linear (default)	Linear interpolation
Spline	Cubic spline interpolation
Cubic	Piecewise cubic Hermite interpolation

Examples

```
data = rfckt.datafile;  
data.IntpType = 'cubic';
```

Name property

Class: rfckt.datafile

Package: rfckt

Object name

Values

'Data object'

Description

Read-only string that contains the name of the object.

Examples

```
data = rfckt.datafile;  
data.Name
```

```
ans =
```

```
    Data object
```

nPort property

Class: rfckt.datafile

Package: rfckt

Number of ports

Values

2

Description

A read-only integer that indicates the object has two ports.

Examples

```
data = rfckt.datafile;  
data.nPort
```

```
ans =
```

```
    2
```

AnalyzedResult property

Class: rfckt.delay

Package: rfckt

Computed S-parameters, noise figure, OIP3, and group delay values

Values

rfdata.data object

Description

Handle to an `rfdata.data` object that contains the S-parameters, noise figure, OIP3, and group delay values computed over the specified frequency range using the `analyze` method. This property is empty by default.

The `analyze` method treats the delay line, which can be lossy or lossless, as a 2-port linear network. It computes the `AnalyzedResult` property of the delay line using the data stored in the `rfckt.delay` object properties by calculating the S-parameters for the specified frequencies. This calculation is based on the values of the delay line's `loss`, α , and time delay, D .

$$\begin{cases} S_{11} = 0 \\ S_{12} = e^{-p} \\ S_{21} = e^{-p} \\ S_{22} = 0 \end{cases}$$

Above, $p = \alpha_a + i\beta$, where α_a is the attenuation coefficient and β is the wave number. The attenuation coefficient α_a is related to the loss, α , by

$$\alpha_a = -\ln(10^{\alpha/20})$$

and the wave number β is related to the time delay, D , by

$$\beta = 2\pi fD$$

where f is the frequency range specified in the `analyze` input argument `freq`.

The `analyze` method uses the S-parameters to calculate the group delay values at the frequencies specified in the `analyze` input argument `freq`, as described in the `analyze` reference page.

Examples

Compute S-parameters, noise figure, OIP3, and group delay values:

```
del = rfckt.delay;  
analyze(del, [1e9, 2e9, 3e9]);  
del.AnalyzedResult
```

Loss property

Class: rfckt.delay

Package: rfckt

Delay line loss

Values

Scalar

Description

Line loss value, in decibels. Line loss is the reduction in strength of the signal as it travels over the delay line and must be nonnegative. The default is 0.

Examples

```
del = rfckt.delay;  
del.Loss = 10;
```

Name property

Class: rfckt.delay

Package: rfckt

Object name

Values

'Delay Line'

Description

Read-only string that contains the name of the object.

Examples

```
del = rfckt.delay;  
del.Name
```

```
ans =
```

```
    Delay Line
```

TimeDelay property

Class: rfckt.delay

Package: rfckt

Delay introduced by line

Values

Scalar

Description

The amount of time delay, in seconds. The default is $1.0000e-012$.

Examples

```
del = rfckt.delay;  
del.TimeDelay = 1e-9;
```

Z0 property

Class: rfckt.delay

Package: rfckt

Characteristic impedance

Values

Scalar

Description

The characteristic impedance, in ohms, of the delay line. The default is 50 ohms.

Examples

```
del = rfckt.delay;  
del.Z0 = 75;
```

nPort property

Class: rfckt.delay

Package: rfckt

Number of ports

Values

2

Description

A read-only integer that indicates the object has two ports.

Examples

```
del = rfckt.delay;  
del.nPort
```

```
ans =
```

```
    2
```

AnalyzedResult property

Class: rfckt.hybrid

Package: rfckt

Computed S-parameters, noise figure, OIP3, and group delay values

Values

`rfdata.data` object

Description

Handle to an `rfdata.data` object that contains the S-parameters, noise figure, OIP3, and group delay values computed over the specified frequency range using the `analyze` method. This property is empty by default.

The `analyze` method computes the S-parameters of the `AnalyzedResult` property using the data stored in the `Ckts` property as follows:

- The `analyze` method first calculates the h matrix of the hybrid network. It starts by converting each component network's parameters to an h matrix. The following figure shows a hybrid connected network consisting of two 2-port networks, each represented by its h matrix,

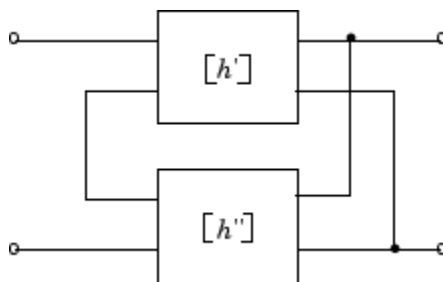

where

$$[h'] = \begin{bmatrix} h_{11}' & h_{12}' \\ h_{21}' & h_{22}' \end{bmatrix}$$
$$[h''] = \begin{bmatrix} h_{11}'' & h_{12}'' \\ h_{21}'' & h_{22}'' \end{bmatrix}$$

- The `analyze` method then calculates the h matrix for the hybrid network by calculating the sum of the h matrices of the individual networks. The following equation illustrates the calculations for two 2-port networks.

$$[h] = \begin{bmatrix} h_{11}' + h_{11}'' & h_{12}' + h_{12}'' \\ h_{21}' + h_{21}'' & h_{22}' + h_{22}'' \end{bmatrix}$$

- Finally, `analyze` converts the h matrix of the hybrid network to S-parameters at the frequencies specified in the `analyze` input argument `freq`.

The `analyze` method uses the hybrid S-parameters to calculate the group delay values at the frequencies specified in the `analyze` input argument `freq`, as described in the `analyze` reference page.

Examples

```
tx1 = rfckt.txline;
tx2 = rfckt.txline;
hyb = rfckt.hybrid('Ckts',{tx1,tx2})
analyze(hyb,[1e9:1e7:2e9]);
hyb.AnalyzedResult
```

```
ans =
```

```
      Name: 'Data object'
      Freq: [101x1 double]
S_Parameters: [2x2x101 double]
  GroupDelay: [101x1 double]
         NF: [101x1 double]
        OIP3: [101x1 double]
         Z0: 50
         ZS: 50
```

ZL: 50
IntpType: 'Linear'

Ckts property

Class: rfckt.hybrid

Package: rfckt

Circuit objects in network

Values

Cell

Description

Cell array containing handles to all circuit objects in the network. All circuits must be 2-port and linear. This property is empty by default.

Examples

```
tx1 = rfckt.txline;  
tx2 = rfckt.txline;  
hyb = rfckt.hybrid;  
hyb.Ckts = {tx1,tx2};  
hyb.Ckts
```

```
ans =
```

```
 [1x1 rfckt.txline] [1x1 rfckt.txline]
```

Name property

Class: rfckt.hybrid

Package: rfckt

Object name

Values

'Hybrid Connected Network'

Description

Read-only string that contains the name of the object.

Examples

```
hyb = rfckt.hybrid;  
hyb.Name
```

```
ans =
```

```
Hybrid Connected Network
```

nPort property

Class: rfckt.hybrid

Package: rfckt

Number of ports

Values

2

Description

A read-only integer that indicates the object has two ports.

Examples

```
hyb = rfckt.hybrid;  
hyb.nPort
```

```
ans =
```

```
    2
```

AnalyzedResult property

Class: rfckt.hybridg

Package: rfckt

Computed S-parameters, noise figure, OIP3, and group delay values

Values

`rfdata.data` object

Description

Handle to an `rfdata.data` object that contains the S-parameters, noise figure, OIP3, and group delay values computed over the specified frequency range using the `analyze` method. This property is empty by default.

The `analyze` method computes the S-parameters of the `AnalyzedResult` property using the data stored in the `Ckts` property as follows:

- 1 The `analyze` method first calculates the g matrix of the inverse hybrid network. It starts by converting each component network's parameters to a g matrix. The following figure shows an inverse hybrid connected network consisting of two 2-port networks, each represented by its g matrix,

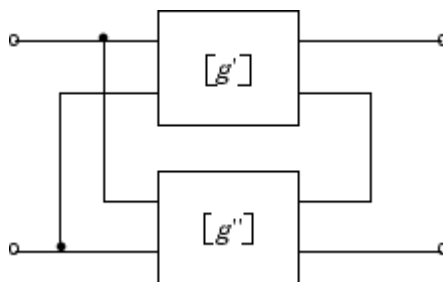

where

$$[g'] = \begin{bmatrix} g_{11}' & g_{12}' \\ g_{21}' & g_{22}' \end{bmatrix}$$

$$[g''] = \begin{bmatrix} g_{11}'' & g_{12}'' \\ g_{21}'' & g_{22}'' \end{bmatrix}$$

- 2 The `analyze` method then calculates the g matrix for the inverse hybrid network by calculating the sum of the g matrices of the individual networks. The following equation illustrates the calculations for two 2-port networks.

$$[g] = \begin{bmatrix} g_{11}' + g_{11}'' & g_{12}' + g_{12}'' \\ g_{21}' + g_{21}'' & g_{22}' + g_{22}'' \end{bmatrix}$$

- 3 Finally, `analyze` converts the g matrix of the inverse hybrid network to S-parameters at the frequencies specified in the `analyze` input argument `freq`.

The `analyze` method uses the inverse hybrid S-parameters to calculate the group delay values at the frequencies specified in the `analyze` input argument `freq`, as described in the `analyze` reference page.

Examples

```
tx1 = rfckt.txline;
tx2 = rfckt.txline;
invhyb = rfckt.hybridg('Ckts',{tx1,tx2})
analyze(invhyb,[1e9:1e7:2e9]);
invhyb.AnalyzedResult
```

```
ans =
```

```
      Name: 'Data object'
      Freq: [101x1 double]
S_Parameters: [2x2x101 double]
  GroupDelay: [101x1 double]
           NF: [101x1 double]
           OIP3: [101x1 double]
           Z0: 50
           ZS: 50
```

ZL: 50
IntpType: 'Linear'

Ckts property

Class: rfckt.hybridg

Package: rfckt

Circuit objects in network

Values

Cell

Description

Cell array containing handles to all circuit objects in the network. All circuits must be 2-port and linear. This property is empty by default.

Examples

```
tx1 = rfckt.txline;  
tx2 = rfckt.txline;  
invhyb = rfckt.hybridg;  
invhyb.Ckts = {tx1,tx2};  
invhyb.Ckts
```

```
ans =
```

```
 [1x1 rfckt.txline] [1x1 rfckt.txline]
```

Name property

Class: rfckt.hybridg

Package: rfckt

Object name

Values

'Hybrid G Connected Network'

Description

Read-only string that contains the name of the object.

Examples

```
invhyb = rfckt.hybridg;  
invhyb.Name
```

```
ans =
```

```
Hybrid G Connected Network
```

nPort property

Class: rfckt.hybridg

Package: rfckt

Number of ports

Values

2

Description

A read-only integer that indicates the object has two ports.

Examples

```
invhyb = rfckt.hybridg;  
invhyb.nPort
```

```
ans =
```

```
    2
```

AnalyzedResult property

Class: rfckt.lcbandpasspi

Package: rfckt

Computed S-parameters, noise figure, OIP3, and group delay values

Values

rfdata.data object

Description

Handle to an `rfdata.data` object that contains the S-parameters, noise figure, OIP3, and group delay values computed over the specified frequency range using the `analyze` method. This property is empty by default.

Examples

```
filter = rfckt.lcbandpasspi;  
analyze(filter,[1e9,2e9,3e9]);  
filter.AnalyzedResult
```

```
ans =
```

```
    Name: 'Data object'  
    Freq: [3x1 double]  
    S_Parameters: [2x2x3 double]  
    GroupDelay: [3x1 double]  
    NF: [3x1 double]  
    OIP3: [3x1 double]  
    Z0: 50  
    ZS: 50  
    ZL: 50  
    IntpType: 'Linear'
```

C property

Class: rfckt.lcbandpasspi

Package: rfckt

Capacitance data

Values

Vector

Description

Capacitance values in farads, in order from source to load, of all capacitors in the network. The length of the capacitance vector must be equal to the length of the vector you provide for 'L'. All values must be strictly positive. The default is [0.3579e-10, 0.0118e-10, 0.3579e-10].

Examples

```
filter=rfckt.lcbandpasspi;  
filter.C = [10.1 4.5 14.2]*1e-12;
```

L property

Class: rfckt.lcbandpasspi

Package: rfckt

Inductance data

Values

Vector

Description

Inductance values in henries, in order from source to load, of all inductors in the network. The length of the inductance vector must be equal to the length of the vector you provide for 'C'. All values must be strictly positive. The default is [0.0144e-7, 0.4395e-7, 0.0144e-7].

Examples

```
filter = rfckt.lcbandpasspi;  
filter.L = [3.1 5.9 16.3]*1e-9;
```

Name property

Class: rfckt.lcbandpasspi

Package: rfckt

Object name

Values

'LC Bandpass Pi'

Description

Read-only string that contains the name of the object.

Examples

```
filter = rfckt.lcbandpasspi;  
filter.Name
```

```
ans =
```

```
    LC Bandpass Pi
```

nPort property

Class: rfckt.lcbandpasspi

Package: rfckt

Number of ports

Values

2

Description

A read-only integer that indicates the object has two ports.

Examples

```
filter = rfckt.lcbandpasspi;  
filter.nPort
```

```
ans =
```

```
2
```

AnalyzedResult property

Class: rfckt.lcbandpasstee

Package: rfckt

Computed S-parameters, noise figure, OIP3, and group delay values

Values

rfdata.data object

Description

Handle to an `rfdata.data` object that contains the S-parameters, noise figure, OIP3, and group delay values computed over the specified frequency range using the `analyze` method. This property is empty by default.

Examples

```
filter = rfckt.lcbandpasstee;  
analyze(filter,[1e9,2e9,3e9]);  
filter.AnalyzedResult
```

```
ans =
```

```
    Name: 'Data object'  
    Freq: [3x1 double]  
    S_Parameters: [2x2x3 double]  
    GroupDelay: [3x1 double]  
    NF: [3x1 double]  
    OIP3: [3x1 double]  
    Z0: 50  
    ZS: 50  
    ZL: 50  
    IntpType: 'Linear'
```

C property

Class: rfckt.lcbandpasstee

Package: rfckt

Capacitance data

Values

Vector

Description

Capacitance values in farads, in order from source to load, of all capacitors in the network. The length of the capacitance vector must be equal to the length of the vector you provide for 'L'. All values must be strictly positive. The default is [0.0186e-10, 0.1716e-10, 0.0186e-10].

Examples

```
filter=rfckt.lcbandpasstee;  
filter.C = [10.1 4.5 14.2]*1e-12;
```

L property

Class: rfckt.lcbandpasstee

Package: rfckt

Inductance data

Values

Vector

Description

Inductance values in henries, in order from source to load, of all inductors in the network. The length of the inductance vector must be equal to the length of the vector you provide for 'C'. All values must be strictly positive. The default is [0.2781e-7, 0.0301e-7, 0.2781e-7].

Examples

```
filter = rfckt.lcbandpasstee;  
filter.L = [3.1 5.9 16.3]*1e-9;
```

Name property

Class: rfckt.lcbandpasstee

Package: rfckt

Object name

Values

'LC Bandpass Tee'

Description

Read-only string that contains the name of the object.

Examples

```
filter = rfckt.lcbandpasstee;  
filter.Name
```

```
ans =
```

```
    LC Bandpass Tee
```

nPort property

Class: rfckt.lcbandpasstee

Package: rfckt

Number of ports

Values

2

Description

A read-only integer that indicates the object has two ports.

Examples

```
filter = rfckt.lcbandpasstee;  
filter.nPort
```

```
ans =
```

```
2
```

AnalyzedResult property

Class: rfckt.lcbandstoppi

Package: rfckt

Computed S-parameters, noise figure, OIP3, and group delay values

Values

rfdata.data object

Description

Handle to an `rfdata.data` object that contains the S-parameters, noise figure, OIP3, and group delay values computed over the specified frequency range using the `analyze` method. This property is empty by default.

Examples

```
filter = rfckt.lcbandstoppi;  
analyze(filter,[1e9,2e9,3e9]);  
filter.AnalyzedResult
```

```
ans =
```

```
    Name: 'Data object'  
    Freq: [3x1 double]  
    S_Parameters: [2x2x3 double]  
    GroupDelay: [3x1 double]  
    NF: [3x1 double]  
    OIP3: [3x1 double]  
    Z0: 50  
    ZS: 50  
    ZL: 50  
    IntpType: 'Linear'
```

C property

Class: rfckt.lcbandstoppi

Package: rfckt

Capacitance data

Values

Vector

Description

Capacitance values in farads, in order from source to load, of all capacitors in the network. The length of the capacitance vector must be equal to the length of the vector you provide for 'L'. All values must be strictly positive. The default is [0.0184e-10, 0.2287e-10, 0.0184e-10].

Examples

```
filter=rfckt.lcbandstoppi;  
filter.C = [10.1 4.5 14.2]*1e-12;
```

L property

Class: rfckt.lcbandstoppi

Package: rfckt

Inductance data

Values

Vector

Description

Inductance values in henries, in order from source to load, of all inductors in the network. The length of the inductance vector must be equal to the length of the vector you provide for 'C'. All values must be strictly positive. The default is [0.2809e-7, 0.0226e-7, 0.2809e-7].

Examples

```
filter = rfckt.lcbandstoppi;  
filter.L = [3.1 5.9 16.3]*1e-9;
```

Name property

Class: rfckt.lcbandstoppi

Package: rfckt

Object name

Values

'LC Bandstop Pi'

Description

Read-only string that contains the name of the object.

Examples

```
filter = rfckt.lcbandstoppi;  
filter.Name
```

```
ans =
```

```
    LC Bandstop Pi
```

nPort property

Class: rfckt.lcbandstoppi

Package: rfckt

Number of ports

Values

2

Description

A read-only integer that indicates the object has two ports.

Examples

```
filter = rfckt.lcbandstoppi;  
filter.nPort
```

```
ans =
```

```
    2
```

AnalyzedResult property

Class: rfckt.lcbandstoptee

Package: rfckt

Computed S-parameters, noise figure, OIP3, and group delay values

Values

rfdata.data object

Description

Handle to an `rfdata.data` object that contains the S-parameters, noise figure, OIP3, and group delay values computed over the specified frequency range using the `analyze` method. This property is empty by default.

Examples

```
filter = rfckt.lcbandstoptee;  
analyze(filter,[1e9,2e9,3e9]);  
filter.AnalyzedResult
```

```
ans =
```

```
    Name: 'Data object'  
    Freq: [3x1 double]  
    S_Parameters: [2x2x3 double]  
    GroupDelay: [3x1 double]  
    NF: [3x1 double]  
    OIP3: [3x1 double]  
    Z0: 50  
    ZS: 50  
    ZL: 50  
    IntpType: 'Linear'
```

C property

Class: rfckt.lcbandstoptee

Package: rfckt

Capacitance data

Values

Vector

Description

Capacitance values in farads, in order from source to load, of all capacitors in the network. The length of the capacitance vector must be equal to the length of the vector you provide for 'L'. All values must be strictly positive. The default is [0.1852e-10, 0.0105e-10, 0.1852e-10].

Examples

```
filter=rfckt.lcbandstoptee;  
filter.C = [10.1 4.5 14.2]*1e-12;
```

L property

Class: rfckt.lcbandstoptee

Package: rfckt

Inductance data

Values

Vector

Description

Inductance values in henries, in order from source to load, of all inductors in the network. The length of the inductance vector must be equal to the length of the vector you provide for 'C'. All values must be strictly positive. The default is [0.0279e-7, 0.4932e-7, 0.0279e-7].

Examples

```
filter = rfckt.lcbandstoptee;  
filter.L = [3.1 5.9 16.3]*1e-9;
```

Name property

Class: rfckt.lcbandstoptee

Package: rfckt

Object name

Values

'LC Bandstop Tee'

Description

Read-only string that contains the name of the object.

Examples

```
filter = rfckt.lcbandstoptee;  
filter.Name
```

```
ans =
```

```
    LC Bandstop Tee
```

nPort property

Class: rfckt.lcbandstoptee

Package: rfckt

Number of ports

Values

2

Description

A read-only integer that indicates the object has two ports.

Examples

```
filter = rfckt.lcbandstoptee;  
filter.nPort
```

```
ans =
```

```
    2
```

AnalyzedResult property

Class: rfckt.lchighpasspi

Package: rfckt

Computed S-parameters, noise figure, OIP3, and group delay values

Values

rfdata.data object

Description

Handle to an `rfdata.data` object that contains the S-parameters, noise figure, OIP3, and group delay values computed over the specified frequency range using the `analyze` method. This property is empty by default.

Examples

```
filter = rfckt.lchighpasspi;  
analyze(filter,[1e9,2e9,3e9]);  
filter.AnalyzedResult
```

```
ans =
```

```
    Name: 'Data object'  
    Freq: [3x1 double]  
    S_Parameters: [2x2x3 double]  
    GroupDelay: [3x1 double]  
    NF: [3x1 double]  
    OIP3: [3x1 double]  
    Z0: 50  
    ZS: 50  
    ZL: 50  
    IntpType: 'Linear'
```

C property

Class: rfckt.lchighpasspi

Package: rfckt

Capacitance data

Values

Vector

Description

Capacitance values in farads, in order from source to load, of all capacitors in the network. The length of the capacitance vector must be equal to the length of the vector you provide for 'L'. All values must be strictly positive. The default is [0.1188e-5, 0.1188e-5].

Examples

```
filter=rfckt.lchighpasspi;  
filter.C = [10.1 4.5 14.2]*1e-12;
```

L property

Class: rfckt.lchighpasspi

Package: rfckt

Inductance data

Values

Vector

Description

Inductance values in henries, in order from source to load, of all inductors in the network. The length of the inductance vector must be equal to the length of the vector you provide for 'C'. All values must be strictly positive. The default is [2.2363e-9].

Examples

```
filter = rfckt.lchighpasspi;  
filter.L = [3.1 5.9 16.3]*1e-9;
```

Name property

Class: rfckt.lchighpasspi

Package: rfckt

Object name

Values

'LC Highpass Pi'

Description

Read-only string that contains the name of the object.

Examples

```
filter = rfckt.lchighpasspi;  
filter.Name
```

```
ans =
```

```
    LC Highpass Pi
```

nPort property

Class: rfckt.lchighpasspi

Package: rfckt

Number of ports

Values

2

Description

A read-only integer that indicates the object has two ports.

Examples

```
filter = rfckt.lchighpasspi;  
filter.nPort
```

```
ans =
```

```
    2
```

AnalyzedResult property

Class: rfckt.lchighpasstee

Package: rfckt

Computed S-parameters, noise figure, OIP3, and group delay values

Values

rfdata.data object

Description

Handle to an `rfdata.data` object that contains the S-parameters, noise figure, OIP3, and group delay values computed over the specified frequency range using the `analyze` method. This property is empty by default.

Examples

```
filter = rfckt.lchighpasstee;  
analyze(filter,[1e9,2e9,3e9]);  
filter.AnalyzedResult
```

```
ans =
```

```
    Name: 'Data object'  
    Freq: [3x1 double]  
    S_Parameters: [2x2x3 double]  
    GroupDelay: [3x1 double]  
    NF: [3x1 double]  
    OIP3: [3x1 double]  
    Z0: 50  
    ZS: 50  
    ZL: 50  
    IntpType: 'Linear'
```

C property

Class: rfckt.lchighpasstee

Package: rfckt

Capacitance data

Values

Vector

Description

Capacitances values in farads, in order from source to load, of all capacitors in the network. The length of the capacitance vector must be equal to the length of the vector you provide for 'L'. All values must be strictly positive. The default is [0.4752e-9, 0.4752e-9].

Examples

```
filter=rfckt.lchighpasstee;  
filter.C = [10.1 4.5 14.2]*1e-12;
```

L property

Class: rfckt.lchighpasstee

Package: rfckt

Inductance data

Values

Vector

Description

Inductance values in henries, in order from source to load, of all inductors in the network. The length of the inductance vector must be equal to the length of the vector you provide for 'C'. All values must be strictly positive. The default is [5.5907e-6].

Examples

```
filter = rfckt.lchighpasstee;  
filter.L = [3.1 5.9 16.3]*1e-9;
```

Name property

Class: rfckt.lchighpasstee

Package: rfckt

Object name

Values

'LC Highpass Tee'

Description

Read-only string that contains the name of the object.

Examples

```
filter = rfckt.lchighpasstee;  
filter.Name
```

```
ans =
```

```
    LC Highpass Tee
```

nPort property

Class: rfckt.lchighpasstee

Package: rfckt

Number of ports

Values

2

Description

A read-only integer that indicates the object has two ports.

Examples

```
filter = rfckt.lchighpasstee;  
filter.nPort
```

```
ans =
```

```
    2
```

AnalyzedResult property

Class: rfckt.lclowpasspi

Package: rfckt

Computed S-parameters, noise figure, OIP3, and group delay values

Values

rfdata.data object

Description

Handle to an `rfdata.data` object that contains the S-parameters, noise figure, OIP3, and group delay values computed over the specified frequency range using the `analyze` method. This property is empty by default.

Examples

```
filter = rfckt.lclowpasspi;  
analyze(filter,[1e9,2e9,3e9]);  
filter.AnalyzedResult
```

```
ans =
```

```
    Name: 'Data object'  
    Freq: [3x1 double]  
    S_Parameters: [2x2x3 double]  
    GroupDelay: [3x1 double]  
    NF: [3x1 double]  
    OIP3: [3x1 double]  
    Z0: 50  
    ZS: 50  
    ZL: 50  
    IntpType: 'Linear'
```

C property

Class: rfckt.lclowpasspi

Package: rfckt

Capacitance data

Values

Vector

Description

Capacitance values in farads, in order from source to load, of all capacitors in the network. The length of the capacitance vector must be equal to or one greater than the length of the vector you provide for 'L'. All values must be strictly positive. The default is [0.5330e-8, 0.5330e-8].

Examples

```
filter=rfckt.lclowpasspi;  
filter.C = [10.1 4.5 14.2]*1e-12;
```

L property

Class: rfckt.lclowpasspi

Package: rfckt

Inductance data

Values

Vector

Description

Inductance values in henries, in order from source to load, of all inductors in the network. The length of the inductance vector must be equal to or one less than the length of the vector you provide for 'C'. All values must be strictly positive. The default is [2.8318e-6].

Examples

```
filter = rfckt.lclowpasspi;  
filter.L = [3.1 5.9 16.3]*1e-9;
```

Name property

Class: rfckt.lclowpasspi

Package: rfckt

Object name

Values

'LC Lowpass Pi'

Description

Read-only string that contains the name of the object.

Examples

```
filter = rfckt.lclowpasspi;  
filter.Name
```

```
ans =
```

```
    LC Lowpass Pi
```

nPort property

Class: rfckt.lclowpasspi

Package: rfckt

Number of ports

Values

2

Description

A read-only integer that indicates the object has two ports.

Examples

```
filter = rfckt.lclowpasspi;  
filter.nPort
```

```
ans =
```

```
    2
```

AnalyzedResult property

Class: rfckt.lclowpasstee

Package: rfckt

Computed S-parameters, noise figure, OIP3, and group delay values

Values

rfdata.data object

Description

Handle to an `rfdata.data` object that contains the S-parameters, noise figure, OIP3, and group delay values computed over the specified frequency range using the `analyze` method. This property is empty by default.

Examples

```
filter = rfckt.lclowpasstee;  
analyze(filter,[1e9,2e9,3e9]);  
filter.AnalyzedResult
```

```
ans =
```

```
    Name: 'Data object'  
    Freq: [3x1 double]  
    S_Parameters: [2x2x3 double]  
    GroupDelay: [3x1 double]  
    NF: [3x1 double]  
    OIP3: [3x1 double]  
    Z0: 50  
    ZS: 50  
    ZL: 50  
    IntpType: 'Linear'
```

C property

Class: rfckt.lclowpasstee

Package: rfckt

Capacitance data

Values

Vector

Description

Capacitance values in farads, in order from source to load, of all capacitors in the network. The length of the capacitance vector must be equal to or one less than the length of the vector you provide for 'L'. All values must be strictly positive. The default is $[1.1327e-9]$.

Examples

```
filter=rfckt.lclowpasstee;  
filter.C = [10.1 4.5 14.2]*1e-12;
```

L property

Class: rfckt.lclowpasstee

Package: rfckt

Inductance data

Values

Vector

Description

Inductance values in henries, in order from source to load, of all inductors in the network. The length of the inductance vector must be equal to or one greater than the length of the vector you provide for 'C'. All values must be strictly positive. The default is [0.1332e-4, 0.1332e-4].

Examples

```
filter = rfckt.lclowpasstee;  
filter.L = [3.1 5.9 16.3]*1e-9;
```

Name property

Class: rfckt.lclowpasstee

Package: rfckt

Object name

Values

'LC Lowpass Tee'

Description

Read-only string that contains the name of the object.

Examples

```
filter = rfckt.lclowpasstee;  
filter.Name
```

```
ans =
```

```
    LC Lowpass Tee
```

nPort property

Class: rfckt.lclowpasstee

Package: rfckt

Number of ports

Values

2

Description

A read-only integer that indicates the object has two ports.

Examples

```
filter = rfckt.lclowpasstee;  
filter.nPort
```

```
ans =
```

```
    2
```

AnalyzedResult property

Class: rfckt.microstrip

Package: rfckt

Computed S-parameters, noise figure, OIP3, and group delay values

Values

rfdata.data object

Description

Handle to an `rfdata.data` object that contains the S-parameters, noise figure, OIP3, and group delay values computed over the specified frequency range using the `analyze` method. This property is empty by default.

The `analyze` method treats the microstrip line as a 2-port linear network and models the line as a transmission line with optional stubs. The `analyze` method computes the `AnalyzedResult` property of the transmission line using the data stored in the `rfckt.microstrip` object properties as follows:

-

If you model the transmission line as a stubless line, the `analyze` method first calculates the ABCD-parameters at each frequency contained in the modeling frequencies vector. It then uses the `abcd2s` function to convert the ABCD-parameters to S-parameters.

The `analyze` method calculates the ABCD-parameters using the physical length of the transmission line, d , and the complex propagation constant, k , using the following equations:

$$A = \frac{e^{kd} + e^{-kd}}{2}$$

$$B = \frac{Z_0 * (e^{kd} - e^{-kd})}{2}$$

$$C = \frac{e^{kd} - e^{-kd}}{2 * Z_0}$$

$$D = \frac{e^{kd} + e^{-kd}}{2}$$

Z_0 and k are vectors whose elements correspond to the elements of f , the vector of frequencies specified in the `analyze` input argument `freq`. Both can be expressed in terms of the specified conductor strip width, substrate height, conductor strip thickness, relative permittivity constant, conductivity, and dielectric loss tangent of the microstrip line, as described in [1].

- If you model the transmission line as a shunt or series stub, the `analyze` method first calculates the ABCD-parameters at the specified frequencies. It then uses the `abcd2s` function to convert the ABCD-parameters to S-parameters.

When you set the `StubMode` property to 'Shunt', the 2-port network consists of a stub transmission line that you can terminate with either a short circuit or an open circuit as shown in the following figure.

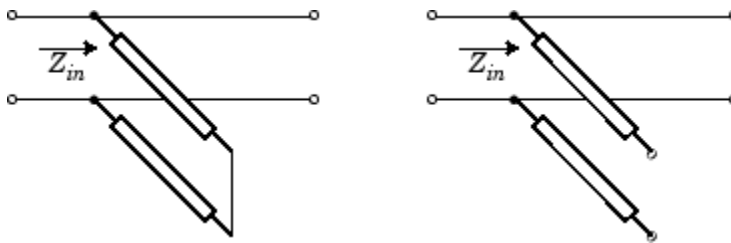

Z_{in} is the input impedance of the shunt circuit. The ABCD-parameters for the shunt stub are calculated as:

$$\begin{aligned}
 A &= 1 \\
 B &= 0 \\
 C &= 1 / Z_{in} \\
 D &= 1
 \end{aligned}$$

When you set the `StubMode` property to 'Series', the 2-port network consists of a series transmission line that you can terminate with either a short circuit or an open circuit as shown in the following figure.

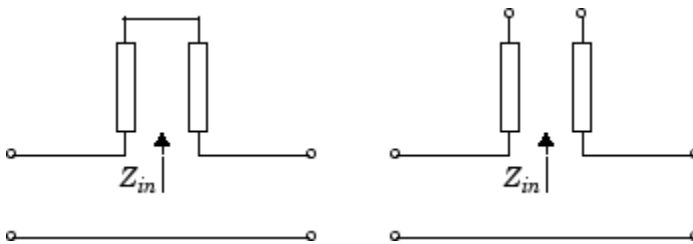

Z_{in} is the input impedance of the series circuit. The ABCD-parameters for the series stub are calculated as:

$$\begin{aligned}
 A &= 1 \\
 B &= Z_{in} \\
 C &= 0 \\
 D &= 1
 \end{aligned}$$

The `analyze` method uses the S-parameters to calculate the group delay values at the frequencies specified in the `analyze` input argument `freq`, as described in the `analyze` reference page.

Examples

```
tx1 = rfckt.microstrip;
analyze(tx1,[1e9,2e9,3e9]);
tx1.AnalyzedResult
```

```
ans =
```

```
Name: 'Data object'  
Freq: [3x1 double]  
S_Parameters: [2x2x3 double]  
GroupDelay: [3x1 double]  
NF: [3x1 double]  
OIP3: [3x1 double]  
Z0: 50  
ZS: 50  
ZL: 50  
IntpType: 'Linear'
```

EpsilonR property

Class: rfckt.microstrip

Package: rfckt

Relative permittivity of dielectric

Values

Scalar

Description

The ratio of the permittivity of the dielectric, ϵ , to the permittivity of free space, ϵ_0 . The default value is 9.8.

Examples

Change the relative permittivity of the dielectric:

```
tx1=rfckt.microstrip;  
tx1.EpsilonR=2.7;
```

Height property

Class: rfckt.microstrip

Package: rfckt

Dielectric thickness

Values

Scalar

Description

Physical height, in meters, of the dielectric on which the microstrip resides. The default is $6.35e-4$.

Examples

```
tx1=rfckt.microstrip;  
tx1.Height=0.001;
```

LineLength property

Class: rfckt.microstrip

Package: rfckt

Microstrip line length

Values

Scalar

Description

The physical length of the transmission line in meters. The default is 0.01.

Examples

```
tx1 = rfckt.microstrip;  
tx1.LineLength = 0.001;
```

LossTangent property

Class: rfckt.microstrip

Package: rfckt

Tangent of loss angle

Values

Scalar

Description

The loss angle tangent of the dielectric. The default is 0.

Examples

```
tx1 = rfckt.microstrip;  
tx1.LossTangent
```

```
ans =
```

```
0
```

Name property

Class: rfckt.microstrip

Package: rfckt

Object name

Values

'Microstrip Waveguide Transmission Line'

Description

Read-only string that contains the name of the object.

Examples

```
tx1 = rfckt.microstrip;  
tx1.Name
```

```
ans =
```

```
Microstrip Transmission Line
```

SigmaCond property

Class: rfckt.microstrip

Package: rfckt

Conductor conductivity

Values

Scalar

Description

Conductivity, in Siemens per meter (S/m), of the conductor. The default is Inf.

Examples

```
tx1=rfckt.microstrip;  
tx1.SigmaCond=5.81e7;
```

StubMode property

Class: rfckt.microstrip

Package: rfckt

Type of stub

Values

'NotAStub' (default), 'Series', or 'Shunt'

Description

String that specifies what type of stub, if any, to include in the transmission line model.

Examples

```
tx1 = rfckt.microstrip;  
tx1.StubMode = 'Series';
```

Termination property

Class: rfckt.microstrip

Package: rfckt

Stub transmission line termination

Values

'NotApplicable' (default), 'Open', or 'Short'.

Description

String that specifies what type of termination to use for 'Shunt' and 'Series' stub modes. `Termination` is ignored if the line has no stub. Use 'NotApplicable' when `StubMode` is 'NotAStub'.

Examples

```
tx1 = rfckt.microstrip;  
tx1.StubMode = 'Series';  
tx1.Termination = 'Short';
```

Thickness property

Class: rfckt.microstrip

Package: rfckt

Microstrip thickness

Values

Scalar

Description

Physical thickness, in meters, of the microstrip. The default is $5.0e-6$.

Examples

```
tx1=rfckt.microstrip;  
tx1.Thickness=2e-6;
```

Width property

Class: rfckt.microstrip

Package: rfckt

Parallel-plate width

Values

Scalar

Description

Physical width, in meters, of the parallel-plate. The default is $6.0e-4$.

Examples

```
tx1=rfckt.microstrip;  
tx1.Thickness=2e-4;
```

nPort property

Class: rfckt.microstrip

Package: rfckt

Number of ports

Values

2

Description

A read-only integer that indicates the object has two ports.

Examples

```
tx1 = rfckt.microstrip;  
tx1.nPort
```

```
ans =
```

```
    2
```

AnalyzedResult property

Class: rfckt.mixer

Package: rfckt

Computed S-parameters, noise figure, OIP3, and group delay values

Values

rfdata.data object

Description

Handle to an `rfdata.data` object that contains the S-parameters, noise figure, OIP3, and group delay values computed over the specified frequency range using the `analyze` method. The default is a 1-by-1 `rfdata.data` object that contains the S-parameters, noise figure, OIP3, and group delay values that result from analyzing the values stored in the `default.amp` file at the frequencies stored in this file.

The `analyze` method computes the `AnalyzedResult` property using the data stored in the `rfckt.mixer` object properties as follows:

- The `analyze` method uses the data stored in the `'NoiseData'` property of the `rfckt.mixer` object to calculate the noise figure.
- The `analyze` method uses the data stored in the `'PhaseNoiseLevel'` property of the `rfckt.mixer` object to calculate phase noise. The `analyze` method first generates additive white Gaussian noise (AWGN) and filters the noise with a digital FIR filter. It then adds the resulting noise to the angle component of the input signal.

The method computes the digital filter by:

- 1 Interpolating the specified phase noise amplitude to determine the phase noise values at the modeling frequencies.
 - 2 Taking the IFFT of the resulting phase noise spectrum to get the coefficients of the FIR filter.
- The `analyze` method uses the data stored in the `'NonlinearData'` property of the `rfckt.mixer` object to calculate OIP3.

If power data exists in the 'NonlinearData' property, the block extracts the AM/AM and AM/PM nonlinearities from the power data.

If the 'NonlinearData' property contains only IP3 data, the method computes and adds the nonlinearity by:

- 1 Using the third-order input intercept point value in dBm to compute the factor, f , that scales the input signal before the mixer object applies the nonlinearity:

$$F_{AM/AM}(u) = u - \frac{u^3}{3}$$

- 2 Computing the scaled input signal by multiplying the mixer input signal by f .
- 3 Limiting the scaled input signal to a maximum value of 1.
- 4 Applying an AM/AM conversion to the mixer gain, according to the following cubic polynomial equation:

$$F_{AM/AM}(u) = u - \frac{u^3}{3}$$

where u is the magnitude of the scaled input signal, which is a unitless normalized input voltage.

- The `analyze` method uses the data stored in the 'NetworkData' property of the `rfckt.mixer` object to calculate the group delay values of the mixer at the frequencies specified in `freq`, as described in the `analyze` reference page.
- The `analyze` method uses the data stored in the 'NetworkData' property of the `rfckt.mixer` object to calculate the S-parameter values of the mixer at the frequencies specified in `freq`. If the 'NetworkData' property contains network Y- or Z-parameters, the `analyze` method first converts the parameters to S-parameters. Using the interpolation method you specify with the 'IntpType' property, the `analyze` method interpolates the S-parameter values to determine their values at the specified frequencies.

Specifically, the `analyze` method orders the S-parameters according to the ascending order of their frequencies, f_n . It then interpolates the S-parameters, using the MATLAB `interp1` function. For example, the curve in the following diagram illustrates the result of interpolating the S_{11} parameters at five different frequencies.

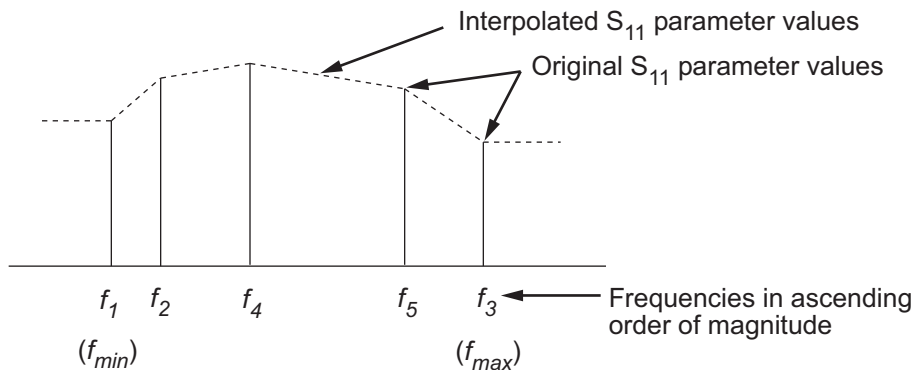

For more information, see “One-Dimensional Interpolation” and the `interp1` reference page in the MATLAB documentation.

As shown in the preceding diagram, the `analyze` method uses the parameter values at f_{min} , the minimum input frequency, for all frequencies smaller than f_{min} . It uses the parameters values at f_{max} , the maximum input frequency, for all frequencies greater than f_{max} . In both cases, the results may not be accurate, so you need to specify network parameter values over a range of frequencies that is wide enough to account for the mixer behavior.

RF Toolbox software computes the reflected wave at the mixer input (b_1) and at the mixer output (b_2) from the interpolated S-parameters as

$$\begin{bmatrix} b_1(f_{in}) \\ b_2(f_{out}) \end{bmatrix} = \begin{bmatrix} S_{11} & S_{12} \\ S_{21} & S_{22} \end{bmatrix} \begin{bmatrix} a_1(f_{in}) \\ a_2(f_{out}) \end{bmatrix}$$

where

- f_{in} and f_{out} are the mixer input and output frequencies, respectively.
- a_1 and a_2 are the incident waves at the mixer input and output, respectively.

The interpolated S_{21} parameter values describe the conversion gain as a function of frequency, referred to the mixer input frequency.

Examples

```
mix1 = rfckt.mixer;  
mix1.AnalyzedResult
```

```
ans =
```

```
    Name: 'Data object'  
    Freq: [191x1 double]  
    S_Parameters: [2x2x191 double]  
    GroupDelay: [191x1 double]  
    NF: [191x1 double]  
    OIP3: [191x1 double]  
    ZO: 50  
    ZS: 50  
    ZL: 50  
    IntpType: 'Linear'
```

FLO property

Class: rfckt.mixer

Package: rfckt

Local oscillator frequency

Values

Scalar

Description

Frequency, in hertz, of the local oscillator. The default is $1.0e+9$.

If the `MixerType` property is set to 'Downconverter', the mixer output frequency is calculated as $f_{out} = f_{in} - f_{lo}$. If the `MixerType` property is set to 'Upconverter', the mixer output frequency is calculated as $f_{out} = f_{in} + f_{lo}$.

Examples

```
mix1 = rfckt.mixer;  
mix1.FLO = 1.6e9;
```

FreqOffset property

Class: rfckt.mixer

Package: rfckt

Frequency offset data

Values

Vector

Description

Vector specifying the frequency offset values, in hertz, that correspond to the phase noise level values specified by the `PhaseNoiseLevel` property. This property is empty by default.

Examples

```
mix1 = rfckt.mixer;  
mix1.FreqOffset = [1.6e6, 2.1e6];
```

IntpType property

Class: rfckt.mixer

Package: rfckt

Interpolation method

Values

'Linear' (default), 'Spline', or 'Cubic'

Description

The `analyze` method is flexible in that it does not require the frequencies of the specified S-parameters to match the requested analysis frequencies. If needed, `analyze` applies the interpolation and extrapolation method specified in the `IntpType` property to the specified data to create a new set of data at the requested analysis frequencies. The following table lists the available interpolation methods and describes each one.

Method	Description
Linear (default)	Linear interpolation
Spline	Cubic spline interpolation
Cubic	Piecewise cubic Hermite interpolation

Examples

```
mix1 = rfckt.mixer;
mix1.IntpType = 'cubic'
```

```
mix1 =
```

```
    Name: 'Mixer'
    nPort: 2
    AnalyzedResult: [1x1 rfdata.data]
    IntpType: 'Cubic'
```

```
NetworkData: [1x1 rfddata.network]  
NoiseData: [1x1 rfddata.noise]  
NonlinearData: Inf  
MixerType: 'downconverter'  
FLO: 1.0000e+009  
FreqOffset: []  
PhaseNoiseLevel: []
```

MixerSpurData property

Class: rfckt.mixer

Package: rfckt

Data from mixer spur table

Values

rfdata.mixerspur object

Description

An rfdata.mixerspur object that stores data from an intermodulation table. This property is empty by default.

Examples

```
mix1 = rfckt.mixer;
mix1.MixerSpurData=rfdata.mixerspur('Data',[2 5; 1 0],...
                                     'PinRef',3,'PLORef',5)
mix1 =
```

```
      Name: 'Mixer'
      nPort: 2
  AnalyzedResult: [1x1 rfdata.data]
      IntpType: 'Linear'
  NetworkData: [1x1 rfdata.network]
  NoiseData: [1x1 rfdata.noise]
  NonlinearData: Inf
  MixerSpurData: [1x1 rfdata.mixerspur]
      MixerType: 'Downconverter'
          FLO: 1.0000e+009
      FreqOffset: []
  PhaseNoiseLevel: []
```

MixerType property

Class: rfckt.mixer

Package: rfckt

Type of mixer

Values

'Downconverter' (default) or 'Upconverter'

Description

String specifying whether the mixer downconverting or upconverting.

Examples

```
mix1 = rfckt.mixer;  
mix1.MixerType = 'Upconverter';
```

Name property

Class: rfckt.mixer

Package: rfckt

Object name

Values

'Mixer'

Description

Read-only string that contains the name of the object.

Examples

```
mix1 = rfckt.mixer;  
mix1.Name
```

```
ans =
```

```
    Mixer
```

NetworkData property

Class: rfckt.mixer

Package: rfckt

Network parameter information

Values

rfdata.network object

Description

An rfdata.network object that stores network parameter data. The default network parameter values are taken from the 'default.s2p' data file.

Examples

```
mix1 = rfckt.mixer;  
mix1.NetworkData
```

```
ans =
```

```
    Name: 'Network parameters'  
    Type: 'S_PARAMETERS'  
    Freq: [191x1 double]  
    Data: [2x2x191 double]  
    Z0: 50
```

NoiseData property

Class: rfckt.mixer

Package: rfckt

Noise information

Values

Scalar noise figure in decibels, `rfdata.noise` object or `rfdata.nf` object

Description

A scalar value or object that stores noise data. The default is an `rfdata.noise` object whose values are taken from the 'default.s2p' data file.

Examples

```
mix1 = rfckt.mixer;  
mix1.NoiseData
```

```
ans =
```

```
    Name: 'Spot noise data'  
    Freq: [9x1 double]  
    FMIN: [9x1 double]  
    GAMMAOPT: [9x1 double]  
    RN: [9x1 double]
```

NonlinearData property

Class: rfckt.mixer

Package: rfckt

Nonlinearity information

Values

Scalar OIP3 in decibels relative to one milliwatt, `rfdata.power` object or `rfdata.ip3` object

Description

A scalar value or object that stores nonlinearity data. The default is an `Inf`.

Note: If you set `NonLinearData` using `rfdata.ip3` or `rfdata.power`, then the property is converted from scalar OIP3 format to the format of `rfdata.ip3` or `rfdata.power`.

Examples

```
mix1 = rfckt.mixer;  
mix1.NonlinearData
```

```
ans =
```

```
    Inf
```

PhaseNoiseLevel property

Class: rfckt.mixer

Package: rfckt

Phase noise data

Values

Vector

Description

Vector specifying the phase noise levels, in dBc/Hz, that correspond to the frequency offset values specified by the `FreqOffset` property. This property is empty by default.

Examples

```
mix1 = rfckt.mixer;  
mix1.PhaseNoiseLevel = [-75, -110];
```

nPort property

Class: rfckt.mixer

Package: rfckt

Number of ports

Values

2

Description

A read-only integer that indicates the object has two ports.

Examples

```
mix1 = rfckt.mixer;  
mix1.nPort
```

```
ans =
```

```
    2
```

AnalyzedResult property

Class: rfckt.parallel

Package: rfckt

Computed S-parameters, noise figure, OIP3, and group delay values

Values

`rfdata.data` object

Description

Handle to an `rfdata.data` object that contains the S-parameters, noise figure, OIP3, and group delay values computed over the specified frequency range using the `analyze` method. This property is empty by default.

The `analyze` method computes the S-parameters of the `AnalyzedResult` property using the data stored in the `Ckts` property as follows:

- 1 The `analyze` method first calculates the admittance matrix of the parallel connected network. It starts by converting each component network's parameters to an admittance matrix. The following figure shows a parallel connected network consisting of two 2-port networks, each represented by its admittance matrix,

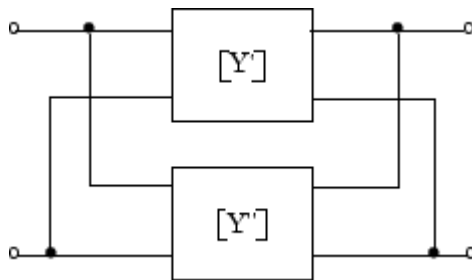

where

$$[Y'] = \begin{bmatrix} Y_{11}' & Y_{12}' \\ Y_{21}' & Y_{22}' \end{bmatrix}$$

$$[Y''] = \begin{bmatrix} Y_{11}'' & Y_{12}'' \\ Y_{21}'' & Y_{22}'' \end{bmatrix}$$

- 2 The `analyze` method then calculates the admittance matrix for the parallel network by calculating the sum of the individual admittances. The following equation illustrates the calculations for two 2-port circuits.

$$[Y] = [Y'] + [Y''] = \begin{bmatrix} Y_{11}' + Y_{11}'' & Y_{12}' + Y_{12}'' \\ Y_{21}' + Y_{21}'' & Y_{22}' + Y_{22}'' \end{bmatrix}$$

- 3 Finally, `analyze` converts the admittance matrix of the parallel network to S-parameters at the frequencies specified in the `analyze` input argument `freq`.

The `analyze` method uses the parallel S-parameters to calculate the group delay values at the frequencies specified in the `analyze` input argument `freq`, as described in the `analyze` reference page.

Examples

```
tx1 = rfckt.txline;
tx2 = rfckt.txline;
ple1 = rfckt.parallel('Ckts',{tx1,tx2})
analyze(ple1,[1e9:1e7:2e9]);
ple1.AnalyzedResult
```

```
ans =
```

```
      Name: 'Data object'
      Freq: [101x1 double]
S_Parameters: [2x2x101 double]
  GroupDelay: [101x1 double]
         NF: [101x1 double]
        OIP3: [101x1 double]
         Z0: 50
         ZS: 50
```

ZL: 50
IntpType: 'Linear'

Ckts property

Class: rfckt.parallel

Package: rfckt

Circuit objects in network

Values

Cell

Description

Cell array containing handles to all circuit objects in the network. All circuits must be 2-port and linear. This property is empty by default.

Examples

```
tx1 = rfckt.txline;  
tx2 = rfckt.txline;  
ple1 = rfckt.parallel;  
ple1.Ckts = {tx1,tx2};  
ple1.Ckts
```

```
ans =
```

```
 [1x1 rfckt.txline] [1x1 rfckt.txline]
```

Name property

Class: rfckt.parallel

Package: rfckt

Object name

Values

'Parallel Connected Network'

Description

Read-only string that contains the name of the object.

Examples

```
ple1 = rfckt.parallel;  
ple1.Name
```

```
ans =
```

```
Parallel Connected Network
```

nPort property

Class: rfckt.parallel

Package: rfckt

Number of ports

Values

2

Description

A read-only integer that indicates the object has two ports.

Examples

```
ple1 = rfckt.parallel;  
ple1.nPort
```

```
ans =
```

```
    2
```

AnalyzedResult property

Class: rfckt.parallelplate

Package: rfckt

Computed S-parameters, noise figure, OIP₃, and group delay values

Values

rfdata.data object

Description

Handle to an `rfdata.data` object that contains the S-parameters, noise figure, OIP₃, and group delay values computed over the specified frequency range using the `analyze` method. This property is empty by default.

The `analyze` method treats the parallel-plate line as a 2-port linear network and models the line as a transmission line with optional stubs. The `analyze` method computes the `AnalyzedResult` property of the line using the data stored in the `rfckt.parallelplate` object properties as follows:

- If you model the transmission line as a stubless line, the `analyze` method first calculates the ABCD-parameters at each frequency contained in the modeling frequencies vector. It then uses the `abcd2s` function to convert the ABCD-parameters to S-parameters.

The `analyze` method calculates the ABCD-parameters using the physical length of the transmission line, d , and the complex propagation constant, k , using the following equations:

$$A = \frac{e^{kd} + e^{-kd}}{2}$$

$$B = \frac{Z_0 * (e^{kd} - e^{-kd})}{2}$$

$$C = \frac{e^{kd} - e^{-kd}}{2 * Z_0}$$

$$D = \frac{e^{kd} + e^{-kd}}{2}$$

Z_0 and k are vectors whose elements correspond to the elements of f , the vector of frequencies specified in the `analyze` input argument `freq`. Both can be expressed in terms of the resistance (R), inductance (L), conductance (G), and capacitance (C) per unit length (meters) as follows:

$$Z_0 = \sqrt{\frac{R + j2\pi fL}{G + j2\pi fC}}$$

$$k = k_r + jk_i = \sqrt{(R + j2\pi fL)(G + j2\pi fC)}$$

where

$$R = \frac{2}{w\sigma_{cond}\delta_{cond}}$$

$$L = \mu \frac{d}{w}$$

$$G = \omega\epsilon'' \frac{w}{d}$$

$$C = \epsilon \frac{w}{d}$$

In these equations:

- w is the plate width.
- d is the plate separation.

- σ_{cond} is the conductivity in the conductor.
- μ is the permeability of the dielectric.
- ε is the permittivity of the dielectric.
- ε'' is the imaginary part of ε , $\varepsilon'' = \varepsilon_0 \varepsilon_r \tan \delta$, where:
 - ε_0 is the permittivity of free space.
 - ε_r is the `EpsilonR` property value.
 - $\tan \delta$ is the `LossTangent` property value.
- δ_{cond} is the skin depth of the conductor, which the block calculates as $1 / \sqrt{\pi f \mu \sigma_{cond}}$.
- f is a vector of modeling frequencies determined by the `Output` block.
- If you model the transmission line as a shunt or series stub, the `analyze` method first calculates the ABCD-parameters at the specified frequencies. It then uses the `abcd2s` function to convert the ABCD-parameters to S-parameters.

When you set the `StubMode` property to 'Shunt', the 2-port network consists of a stub transmission line that you can terminate with either a short circuit or an open circuit as shown in the following figure.

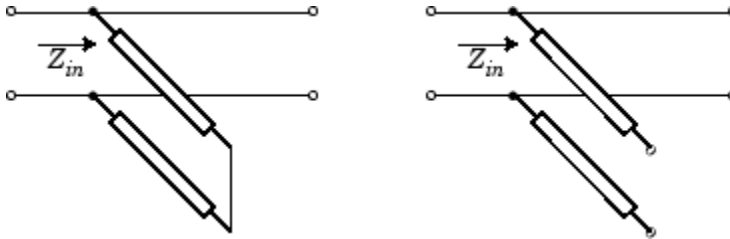

Z_{in} is the input impedance of the shunt circuit. The ABCD-parameters for the shunt stub are calculated as:

$$\begin{aligned}
 A &= 1 \\
 B &= 0 \\
 C &= 1 / Z_{in} \\
 D &= 1
 \end{aligned}$$

When you set the `StubMode` property to 'Series', the 2-port network consists of a series transmission line that you can terminate with either a short circuit or an open circuit as shown in the following figure.

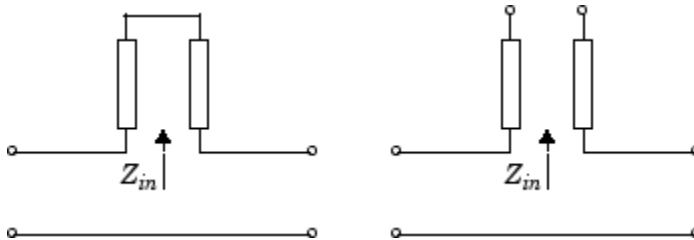

Z_{in} is the input impedance of the series circuit. The ABCD-parameters for the series stub are calculated as:

$$\begin{aligned} A &= 1 \\ B &= Z_{in} \\ C &= 0 \\ D &= 1 \end{aligned}$$

The `analyze` method uses the S-parameters to calculate the group delay values at the frequencies specified in the `analyze` input argument `freq`, as described in the `analyze` reference page.

Examples

```
tx1 = rfckt.parallelplate;
analyze(tx1,[1e9,2e9,3e9]);
tx1.AnalyzedResult
```

```
ans =
```

```
Name: 'Data object'
Freq: [3x1 double]
S_Parameters: [2x2x3 double]
GroupDelay: [3x1 double]
NF: [3x1 double]
OIP3: [3x1 double]
```

Z0: 50
ZS: 50
ZL: 50
IntpType: 'Linear'

EpsilonR property

Class: rfckt.parallelplate

Package: rfckt

Relative permittivity of dielectric

Values

Scalar

Description

The ratio of the permittivity of the dielectric, ϵ , to the permittivity of free space, ϵ_0 . The default value is 2.3.

Examples

```
tx1=rfckt.parallelplate;  
tx1.EpsilonR=2.7;
```

LineLength property

Class: rfckt.parallelplate

Package: rfckt

Parallel-plate line length

Values

Scalar

Description

The physical length of the parallel-plate transmission line in meters. The default is 0.01.

Examples

```
tx1 = rfckt.parallelplate;  
tx1.LineLength = 0.001;
```

LossTangent property

Class: rfckt.parallelplate

Package: rfckt

Tangent of loss angle

Values

Scalar

Description

The loss angle tangent of the dielectric. The default is 0.

Examples

```
tx1=rfckt.parallelplate;  
tx1.LossTangent=0.002;
```

MuR property

Class: rfckt.parallelplate

Package: rfckt

Relative permeability of dielectric

Values

Scalar

Description

The ratio of the permeability of the dielectric, μ , to the permeability of free space, μ_0 . The default value is 1.

Examples

Change the relative permeability of the dielectric:

```
tx1=rfckt.parallelplate;  
tx1.MuR=0.8;
```

Name property

Class: rfckt.parallelplate

Package: rfckt

Object name

Values

'Parallel-Plate Transmission Line'

Description

Read-only string that contains the name of the object.

Examples

```
tx1 = rfckt.parallelplate;  
tx1.Name
```

```
ans =
```

```
Parallel-Plate Transmission Line
```

Separation property

Class: rfckt.parallelplate

Package: rfckt

Distance between plates

Values

Scalar

Description

Thickness, in meters, of the dielectric separating the plates. The default is $1.0e-3$.

Examples

```
tx1=rfckt.parallelplate;  
tx1.Separation=0.8e-3;
```

SigmaCond property

Class: rfckt.parallelplate

Package: rfckt

Conductor conductivity

Values

Scalar

Description

Conductivity, in Siemens per meter (S/m), of the conductor. The default is Inf.

Examples

```
tx1=rfckt.parallelplate;  
tx1.SigmaCond=5.81e7;
```

StubMode property

Class: rfckt.parallelplate

Package: rfckt

Type of stub

Values

'NotAStub' (default), 'Series', or 'Shunt'

Description

String that specifies what type of stub, if any, to include in the transmission line model.

Examples

```
tx1 = rfckt.parallelplate;  
tx1.StubMode = 'Series';
```

Termination property

Class: rfckt.parallelplate

Package: rfckt

Stub transmission line termination

Values

'NotApplicable' (default), 'Open', or 'Short'.

Description

String that specifies what type of termination to use for 'Shunt' and 'Series' stub modes. `Termination` is ignored if the line has no stub. Use 'NotApplicable' when `StubMode` is 'NotAStub'.

Examples

```
tx1 = rfckt.parallelplate;  
tx1.StubMode = 'Series';  
tx1.Termination = 'Short';
```

Width property

Class: rfckt.parallelplate

Package: rfckt

Transmission line width

Values

Scalar

Description

Physical width, in meters, of the parallel-plate transmission line. The default is 0.005.

Examples

```
tx1=rfckt.parallelplate;  
tx1.Width=0.001;
```

nPort property

Class: rfckt.parallelplate

Package: rfckt

Number of ports

Values

2

Description

A read-only integer that indicates the object has two ports.

Examples

```
tx1 = rfckt.parallelplate;  
tx1.nPort
```

```
ans =
```

```
2
```

AnalyzedResult property

Class: rfckt.passive

Package: rfckt

Computed S-parameters, noise figure, OIP3, and group delay values

Values

rfdata.data object

Description

Handle to an `rfdata.data` object that contains the S-parameters, noise figure, OIP3, and group delay values computed over the specified frequency range using the `analyze` method. The default is a 1-by-1 `rfdata.data` object that contains the S-parameters, noise figure, OIP3, and group delay values that result from analyzing the values stored in the `passive.s2p` file at the frequencies stored in this file.

The `analyze` method computes the `AnalyzedResult` property as follows:

The `analyze` method uses the data stored in the `'NetworkData'` property of the `rfckt.passive` object to calculate the S-parameter values of the passive component at the frequencies specified in `freq`. If the `'NetworkData'` property contains network Y- or Z-parameters, the `analyze` method first converts the parameters to S-parameters. Using the interpolation method you specify with the `'IntpType'` property, the `analyze` method interpolates the S-parameter values to determine their values at the specified frequencies.

Specifically, the `analyze` method orders the S-parameters according to the ascending order of their frequencies, f_n . It then interpolates the S-parameters, using the MATLAB `interp1` function. For example, the curve in the following diagram illustrates the result of interpolating the S_{11} parameters at five different frequencies.

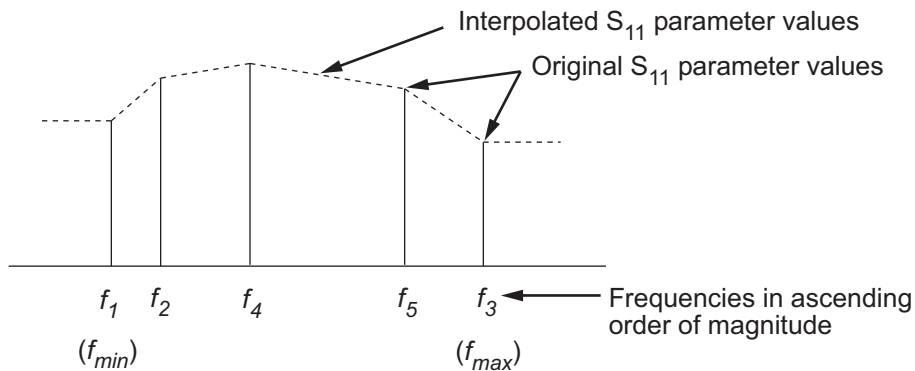

For more information, see “One-Dimensional Interpolation” and the `interp1` reference page in the MATLAB documentation.

As shown in the preceding diagram, the `analyze` method uses the parameter values at f_{min} , the minimum input frequency, for all frequencies smaller than f_{min} . It uses the parameters values at f_{max} , the maximum input frequency, for all frequencies greater than f_{max} . In both cases, the results may not be accurate, so you need to specify network parameter values over a range of frequencies that is wide enough to account for the component behavior.

The `analyze` method uses the S-parameters to calculate the group delay values at the frequencies specified in the `analyze` input argument `freq`, as described in the `analyze` reference page.

Examples

```
pas = rfckt.passive;
pas.AnalyzedResult
```

```
ans =
```

```
Name: 'Data object'
Freq: [202x1 double]
S_Parameters: [2x2x202 double]
GroupDelay: [202x1 double]
NF: [202x1 double]
OIP3: [202x1 double]
```

Z0: 50
ZS: 50
ZL: 50
IntpType: 'Linear'

IntpType property

Class: rfckt.passive

Package: rfckt

Interpolation method

Values

'Linear' (default), 'Spline', or 'Cubic'

Description

The `analyze` method is flexible in that it does not require the frequencies of the specified S-parameters to match the requested analysis frequencies. If needed, `analyze` applies the interpolation and extrapolation method specified in the `IntpType` property to the specified data to create a new set of data at the requested analysis frequencies. The following table lists the available interpolation methods and describes each one.

Method	Description
Linear (default)	Linear interpolation
Spline	Cubic spline interpolation
Cubic	Piecewise cubic Hermite interpolation

Examples

```
pas = rfckt.passive;
pas.IntpType = 'cubic'
```

```
pas =
```

```
    Name: 'Passive'
    nPort: 2
    AnalyzedResult: [1x1 rfdata.data]
    IntpType: 'Cubic'
```

NetworkData: [1x1 rfddata.network]

Name property

Class: rfckt.passive

Package: rfckt

Object name

Values

'Passive'

Description

Read-only string that contains the name of the object.

Examples

```
pas = rfckt.passive;  
pas.Name
```

```
ans =
```

```
    Passive
```

NetworkData property

Class: rfckt.passive

Package: rfckt

Network parameter information

Values

rfdata.network object

Description

An rfdata.network object that stores network parameter data. The default network parameter values are taken from the 'passive.s2p' data file.

Examples

```
pas = rfckt.passive;  
pas.NetworkData
```

```
ans =
```

```
    Name: 'Network parameters'  
    Type: 'S_PARAMETERS'  
    Freq: [202x1 double]  
    Data: [2x2x202 double]  
    Z0: 50
```

nPort property

Class: rfckt.passive

Package: rfckt

Number of ports

Values

2

Description

A read-only integer that indicates the object has two ports.

Examples

```
pas = rfckt.passive;  
pas.nPort
```

```
ans =
```

```
    2
```

AnalyzedResult property

Class: rfckt.rlegline

Package: rfckt

Computed S-parameters, noise figure, OIP3, and group delay values

Values

`rfdata.data` object

Description

Handle to an `rfdata.data` object that contains the S-parameters, noise figure, OIP3, and group delay values computed over the specified frequency range using the `analyze` method. This property is empty by default.

The `analyze` method treats the transmission line, which can be lossy or lossless, as a 2-port linear network. It uses the interpolation method you specify in the `IntpType` property to find the R, L, C, and G values at the frequencies you specify when you call `analyze`. Then, it calculates the characteristic impedance, Z_0 , phase velocity, PV, and loss using these interpolated values. It computes the `AnalyzedResult` property of a stub or as a stubless line using the data stored in the `rfckt.rlcgline` object properties as follows:

- If you model the transmission line as a stubless line, the `analyze` method first calculates the ABCD-parameters at each frequency contained in the modeling frequencies vector. It then uses the `abcd2s` function to convert the ABCD-parameters to S-parameters.

The `analyze` method calculates the ABCD-parameters using the physical length of the transmission line, d , and the complex propagation constant, k , using the following equations:

$$A = \frac{e^{kd} + e^{-kd}}{2}$$

$$B = \frac{Z_0 * (e^{kd} - e^{-kd})}{2}$$

$$C = \frac{e^{kd} - e^{-kd}}{2 * Z_0}$$

$$D = \frac{e^{kd} + e^{-kd}}{2}$$

Z_0 and k are vectors whose elements correspond to the elements of f , the vector of frequencies specified in the **analyze** input argument **freq**. Both can be expressed in terms of the resistance (R), inductance (L), conductance (G), and capacitance (C) per unit length (meters) as follows:

$$Z_0 = \sqrt{\frac{R + j2\pi fL}{G + j2\pi fC}}$$

$$k = k_r + jk_i = \sqrt{(R + j2\pi fL)(G + j2\pi fC)}$$

- If you model the transmission line as a shunt or series stub, the **analyze** method first calculates the ABCD-parameters at the specified frequencies. It then uses the **abcd2s** function to convert the ABCD-parameters to S-parameters.

When you set the **StubMode** property to 'Shunt', the 2-port network consists of a stub transmission line that you can terminate with either a short circuit or an open circuit as shown in the following figure.

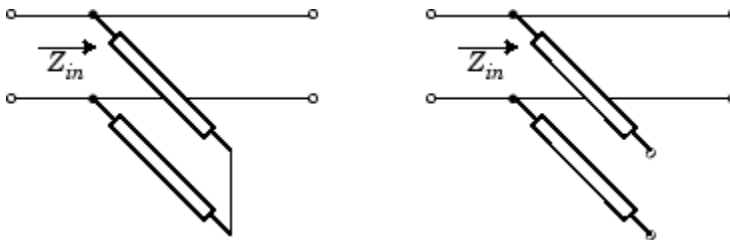

Z_{in} is the input impedance of the shunt circuit. The ABCD-parameters for the shunt stub are calculated as:

$$A = 1$$

$$B = 0$$

$$C = 1 / Z_{in}$$

$$D = 1$$

When you set the `StubMode` property to 'Series', the 2-port network consists of a series transmission line that you can terminate with either a short circuit or an open circuit as shown in the following figure.

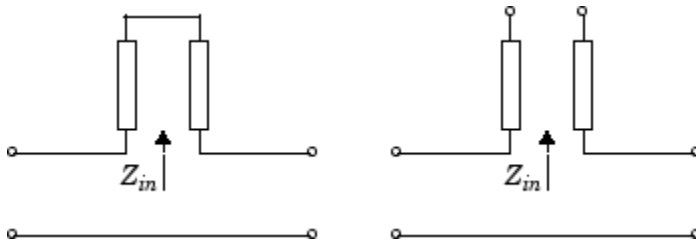

Z_{in} is the input impedance of the series circuit. The ABCD-parameters for the series stub are calculated as:

$$A = 1$$

$$B = Z_{in}$$

$$C = 0$$

$$D = 1$$

The `analyze` method uses the S-parameters to calculate the group delay values at the frequencies specified in the `analyze` input argument `freq`, as described in the `analyze` reference page.

Examples

```
tx1 = rfckt.rlcgline;
analyze(tx1,[1e9,2e9,3e9]);
```



```
tx1.AnalyzedResult
```

```
ans =
```

```
    Name: 'Data object'  
    Freq: [3x1 double]  
    S_Parameters: [2x2x3 double]  
    GroupDelay: [3x1 double]  
    F: [3x1 double]  
    OIP3: [3x1 double]  
    Z0: 50  
    ZS: 50  
    ZL: 50  
    IntpType: 'Linear'
```

C property

Class: rfckt.rlcgline

Package: rfckt

Capacitance data

Values

Vector

Description

Capacitance values per length, in farads per meter, that correspond to the frequencies stored in the `Freq` property. All values must be nonnegative. The default is 0.

Examples

```
tx1=rfckt.rlcgline;  
tx1.C = [10.1 4.5 14.2]*1e-12;
```

Freq property

Class: rfckt.rlcgline

Package: rfckt

Frequency data

Values

Vector

Description

M-element vector of frequency values in hertz for the RLCG values. The values must be positive, and the order of the frequencies must correspond to the order of the RLCG values. The default is **1e9**.

Examples

```
f = [2.08 2.10]*1.0e9;  
tx1 = rfckt.rlcgline;  
tx1.Freq = f;
```

G property

Class: rfckt.rlcgline

Package: rfckt

Conductance data

Values

Vector

Description

Conductances per length, in Siemens per meter, that correspond to the frequencies stored in the Freq property. All values must be nonnegative. The default is 0.

Examples

```
tx1=rfckt.rlcgline;  
tx1.G = [10.1 4.5 14.2]*1e-3;
```

IntpType property

Class: rfckt.rlcgline

Package: rfckt

Interpolation method

Values

'Linear' (default), 'Spline', or 'Cubic'

Description

The `analyze` method is flexible in that it does not require the frequencies of the specified S-parameters to match the requested analysis frequencies. If needed, `analyze` applies the interpolation and extrapolation method specified in the `IntpType` property to the specified data to create a new set of data at the requested analysis frequencies. The following table lists the available interpolation methods and describes each one.

Method	Description
Linear (default)	Linear interpolation
Spline	Cubic spline interpolation
Cubic	Piecewise cubic Hermite interpolation

Examples

```
tx1 = rfckt.rlcgline;  
tx1.IntpType = 'cubic';
```

L property

Class: rfckt.rlcgline

Package: rfckt

Inductance data

Values

Vector

Description

Inductance values per length, in henries per meter, that correspond to the frequencies stored in the `Freq` property. All values must be nonnegative. The default is 0.

Examples

```
filter = rfckt.rlcgline;  
filter.L = [3.1 5.9 16.3]*1e-9;
```

LineLength property

Class: rfckt.rlcgline

Package: rfckt

Transmission line length

Values

Scalar

Description

The physical length of the transmission line in meters. The default is 0.01.

Examples

```
tx1 = rfckt.rlcgline;  
tx1.LineLength = 0.001;
```

Name property

Class: rfckt.rlcgline

Package: rfckt

Object name

Values

'RLCG Transmission Line'

Description

Read-only string that contains the name of the object.

Examples

```
tx1 = rfckt.rlcgline;  
tx1.Name
```

```
ans =
```

```
      RLCG Transmission Line
```

R property

Class: rfckt.rlcgline

Package: rfckt

Resistance data

Values

Vector

Description

Resistance per length, in ohms per meter, that correspond to the frequencies stored in the Freq property. All values must be nonnegative. The default is 0.

Examples

```
filter = rfckt.rlcgline;  
filter.R = [3.1 5.9 16.3]*1e-3;
```

StubMode property

Class: rfckt.rlogline

Package: rfckt

Type of stub

Values

'NotAStub' (default), 'Series', or 'Shunt'

Description

String that specifies what type of stub, if any, to include in the transmission line model.

Examples

```
tx1 = rfckt.rlogline;  
tx1.StubMode = 'Series';
```

Termination property

Class: rfckt.rlcgline

Package: rfckt

Stub transmission line termination

Values

'NotApplicable' (default), 'Open', or 'Short'.

Description

String that specifies what type of termination to use for 'Shunt' and 'Series' stub modes. `Termination` is ignored if the line has no stub. Use 'NotApplicable' when `StubMode` is 'NotAStub'.

Examples

```
tx1 = rfckt.rlcgline;  
tx1.StubMode = 'Series';  
tx1.Termination = 'Short';
```

nPort property

Class: rfckt.rlogline

Package: rfckt

Number of ports

Values

2

Description

A read-only integer that indicates the object has two ports.

Examples

```
tx1 = rfckt.rlogline;  
tx1.nPort
```

```
ans =
```

```
2
```

AnalyzedResult property

Class: rfckt.series

Package: rfckt

Computed S-parameters, noise figure, OIP3, and group delay values

Values

`rfdata.data` object

Description

Handle to an `rfdata.data` object that contains the S-parameters, noise figure, OIP3, and group delay values computed over the specified frequency range using the `analyze` method. This property is empty by default.

The `analyze` method computes the S-parameters of the `AnalyzedResult` property using the data stored in the `Ckts` property as follows:

- 1 The `analyze` method first calculates the impedance matrix of the series connected network. It starts by converting each component network's parameters to an impedance matrix. The following figure shows a series connected network consisting of two 2-port networks, each represented by its impedance matrix,

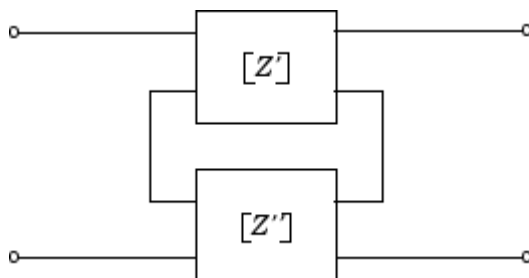

where

$$[Z'] = \begin{bmatrix} Z_{11}' & Z_{12}' \\ Z_{21}' & Z_{22}' \end{bmatrix}$$

$$[Z''] = \begin{bmatrix} Z_{11}'' & Z_{12}'' \\ Z_{21}'' & Z_{22}'' \end{bmatrix}$$

- 2 The `analyze` method then calculates the impedance matrix for the series network by calculating the sum of the individual impedances. The following equation illustrates the calculations for two 2-port circuits.

$$[Z] = [Z'] + [Z''] = \begin{bmatrix} Z_{11}' + Z_{11}'' & Z_{12}' + Z_{12}'' \\ Z_{21}' + Z_{21}'' & Z_{22}' + Z_{22}'' \end{bmatrix}$$

- 3 Finally, `analyze` converts the impedance matrix of the series network to S-parameters at the frequencies specified in the `analyze` input argument `freq`.

The `analyze` method uses the series S-parameters to calculate the group delay values at the frequencies specified in the `analyze` input argument `freq`, as described in the `analyze` reference page.

Examples

```
tx1 = rfckt.txline;
tx2 = rfckt.txline;
ser = rfckt.series('Ckts',{tx1,tx2})
analyze(ser,[1e9:1e7:2e9]);
ser.AnalyzedResult
```

```
ans =
```

```
Name: 'Data object'
Freq: [101x1 double]
S_Parameters: [2x2x101 double]
GroupDelay: [101x1 double]
NF: [101x1 double]
OIP3: [101x1 double]
Z0: 50
ZS: 50
```

ZL: 50
IntpType: 'Linear'

Ckts property

Class: rfckt.series

Package: rfckt

Circuit objects in network

Values

Cell

Description

Cell array containing handles to all circuit objects in the network. All circuits must be 2-port and linear. This property is empty by default.

Examples

```
tx1 = rfckt.txline;  
tx2 = rfckt.txline;  
ser = rfckt.series;  
ser.Ckts = {tx1,tx2};  
ser.Ckts
```

```
ans =
```

```
 [1x1 rfckt.txline] [1x1 rfckt.txline]
```

Name property

Class: rfckt.series

Package: rfckt

Object name

Values

'Series Connected Network'

Description

Read-only string that contains the name of the object.

Examples

```
ser = rfckt.series;  
ser.Name
```

```
ans =
```

```
Series Connected Network
```

nPort property

Class: rfckt.series

Package: rfckt

Number of ports

Values

2

Description

A read-only integer that indicates the object has two ports.

Examples

```
ser = rfckt.series;  
ser.nPort
```

```
ans =
```

```
    2
```

AnalyzedResult property

Class: rfckt.seriesrlc

Package: rfckt

Computed S-parameters, noise figure, OIP3, and group delay values

Values

rfdata.data object

Description

Handle to an `rfdata.data` object that contains the S-parameters, noise figure, OIP3, and group delay values computed over the specified frequency range using the `analyze` method. This property is empty by default.

The `analyze` method computes the S-parameters of the `AnalyzedResult` property using the data stored in the `rfckt.seriesrlc` object properties by first calculating the ABCD-parameters for the circuit, and then converting the ABCD-parameters to S-parameters using the `abcd2s` function. For this circuit, $A = 1$, $B = Z$, $C = 0$, and $D = 1$, where

$$Z = \frac{-LC\omega^2 + jRC\omega + 1}{jC\omega}$$

and $\omega = 2\pi f$.

The `analyze` method uses the S-parameters to calculate the group delay values at the frequencies specified in the `analyze` input argument `freq`, as described in the `analyze` reference page.

Examples

```
rlc1 = rfckt.seriesrlc;
```

```
analyze(rlc1,[1e9,2e9,3e9]);  
rlc1.AnalyzedResult
```

```
ans =
```

```
    Name: 'Data object'  
    Freq: [3x1 double]  
    S_Parameters: [2x2x3 double]  
    GroupDelay: [3x1 double]  
    NF: [3x1 double]  
    OIP3: [3x1 double]  
    Z0: 50  
    ZS: 50  
    ZL: 50  
    IntpType: 'Linear'
```

C property

Class: rfckt.seriesrlc

Package: rfckt

Capacitance value

Values

Scalar

Description

Positive capacitance value in farads. The default is Inf.

Examples

```
rlc1=rfckt.seriesrlc;  
rlc1.C = 1e-12;
```

L property

Class: rfckt.seriesrlc

Package: rfckt

Inductance value

Values

Scalar

Description

Positive inductance value in henries. The default is 0.

Examples

```
rlc1 = rfckt.seriesrlc;  
rlc1.L = 1e-9;
```

Name property

Class: rfckt.seriesrlc

Package: rfckt

Object name

Values

'Series RLC'

Description

Read-only string that contains the name of the object.

Examples

```
rlc1 = rfckt.seriesrlc;  
rlc1.Name
```

```
ans =
```

```
Series RLC
```

R property

Class: rfckt.seriesrlc

Package: rfckt

Resistance value

Values

Scalar

Description

Positive resistance in ohms. The default is 0.

Examples

```
rlc1 = rfckt.seriesrlc;  
rlc1.R = 10;
```

nPort property

Class: rfckt.seriesrlc

Package: rfckt

Number of ports

Values

2

Description

A read-only integer that indicates the object has two ports.

Examples

```
filter = rfckt.seriesrlc;  
filter.nPort
```

```
ans =
```

```
2
```

AnalyzedResult property

Class: rfckt.shuntrlc

Package: rfckt

Computed S-parameters, noise figure, OIP3, and group delay values

Values

rfdata.data object

Description

Handle to an `rfdata.data` object that contains the S-parameters, noise figure, OIP3, and group delay values computed over the specified frequency range using the `analyze` method. This property is empty by default.

The `analyze` method computes the S-parameters of the `AnalyzedResult` property using the data stored in the `rfckt.shuntrlc` object properties by first calculating the ABCD-parameters for the circuit, and then converting the ABCD-parameters to S-parameters using the `abcd2s` function. For this circuit, $A = 1$, $B = 0$, $C = Y$, and $D = 1$, where

$$Y = \frac{-LC\omega^2 + j(L/R)\omega + 1}{jL\omega}$$

and $\omega = 2\pi f$.

The `analyze` method uses the S-parameters to calculate the group delay values at the frequencies specified in the `analyze` input argument `freq`, as described in the `analyze` reference page.

Examples

```
rlc1 = rfckt.shuntrlc;
```

```
analyze(rlc1,[1e9,2e9,3e9]);  
rlc1.AnalyzedResult
```

```
ans =
```

```
    Name: 'Data object'  
    Freq: [3x1 double]  
    S_Parameters: [2x2x3 double]  
    GroupDelay: [3x1 double]  
    NF: [3x1 double]  
    OIP3: [3x1 double]  
    Z0: 50  
    ZS: 50  
    ZL: 50  
    IntpType: 'Linear'
```

C property

Class: rfckt.shuntrlc

Package: rfckt

Capacitance value

Values

Scalar

Description

Positive capacitance value in farads. The default is 0.

Examples

```
rlc1=rfckt.shuntrlc;  
rlc1.C = 1e-12;
```

L property

Class: rfckt.shuntrlc

Package: rfckt

Inductance value

Values

Scalar

Description

Positive inductance value in henries. The default is Inf.

Examples

```
rlc1 = rfckt.shuntrlc;  
rlc1.L = 1e-9;
```

Name property

Class: rfckt.shuntrlc

Package: rfckt

Object name

Values

'Shunt RLC'

Description

Read-only string that contains the name of the object.

Examples

```
rlc1 = rfckt.shuntrlc;  
rlc1.Name
```

```
ans =
```

```
    Shunt RLC
```

R property

Class: rfckt.shuntrlc

Package: rfckt

Resistance value

Values

Scalar

Description

Positive resistance in ohms. The default is `Inf`.

Examples

```
rlc1 = rfckt.shuntrlc;  
rlc1.R = 10;
```

nPort property

Class: rfckt.shuntrlc

Package: rfckt

Number of ports

Values

2

Description

A read-only integer that indicates the object has two ports.

Examples

```
filter = rfckt.shuntrlc;  
filter.nPort
```

```
ans =
```

```
    2
```

AnalyzedResult property

Class: rfckt.twowire

Package: rfckt

Computed S-parameters, noise figure, OIP3, and group delay values

Values

rfdata.data object

Description

Handle to an `rfdata.data` object that contains the S-parameters, noise figure, OIP3, and group delay values computed over the specified frequency range using the `analyze` method. This property is empty by default.

The `analyze` method treats the transmission line, which can be lossy or lossless, as a 2-port linear network. It computes the **AnalyzedResult** property of a stub or as a stubless line using the data stored in the `rfckt.twowire` object properties as follows:

- If you model the transmission line as a stubless line, the `analyze` method first calculates the ABCD-parameters at each frequency contained in the modeling frequencies vector. It then uses the `abcd2s` function to convert the ABCD-parameters to S-parameters.

The `analyze` method calculates the ABCD-parameters using the physical length of the transmission line, d , and the complex propagation constant, k , using the following equations:

$$A = \frac{e^{kd} + e^{-kd}}{2}$$

$$B = \frac{Z_0 * (e^{kd} - e^{-kd})}{2}$$

$$C = \frac{e^{kd} - e^{-kd}}{2 * Z_0}$$

$$D = \frac{e^{kd} + e^{-kd}}{2}$$

Z_0 and k are vectors whose elements correspond to the elements of f , the vector of frequencies specified in the `analyze` input argument `freq`. Both can be expressed in terms of the resistance (R), inductance (L), conductance (G), and capacitance (C) per unit length (meters) as follows:

$$Z_0 = \sqrt{\frac{R + j2\pi fL}{G + j2\pi fC}}$$

$$k = k_r + jk_i = \sqrt{(R + j2\pi fL)(G + j2\pi fC)}$$

where

$$R = \frac{1}{\pi a \sigma_{cond} \delta_{cond}}$$

$$L = \frac{\mu}{\pi} a \cosh\left(\frac{D}{2a}\right)$$

$$G = \frac{\pi \omega \epsilon''}{a \cosh\left(\frac{D}{2a}\right)}$$

$$C = \frac{\pi \epsilon}{a \cosh\left(\frac{D}{2a}\right)}$$

In these equations:

- w is the plate width.
- d is the plate separation.
- σ_{cond} is the conductivity in the conductor.
- μ is the permeability of the dielectric.
- ε is the permittivity of the dielectric.
- ε'' is the imaginary part of ε , $\varepsilon'' = \varepsilon_0 \varepsilon_r \tan \delta$, where:
 - ε_0 is the permittivity of free space.
 - ε_r is the `EpsilonR` property value.
 - $\tan \delta$ is the `LossTangent` property value.
- δ_{cond} is the skin depth of the conductor, which the block calculates as

$$1 / \sqrt{\pi f \mu \sigma_{cond}} .$$
- f is a vector of modeling frequencies determined by the `Output` block.
- If you model the transmission line as a shunt or series stub, the `analyze` method first calculates the ABCD-parameters at the specified frequencies. It then uses the `abcd2s` function to convert the ABCD-parameters to S-parameters.

When you set the `StubMode` property to 'Shunt', the 2-port network consists of a stub transmission line that you can terminate with either a short circuit or an open circuit as shown in the following figure.

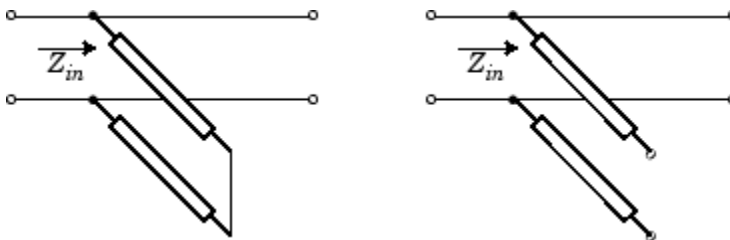

Z_{in} is the input impedance of the shunt circuit. The ABCD-parameters for the shunt stub are calculated as:

$$\begin{aligned}
 A &= 1 \\
 B &= 0 \\
 C &= 1 / Z_{in} \\
 D &= 1
 \end{aligned}$$

When you set the `StubMode` property to 'Series', the 2-port network consists of a series transmission line that you can terminate with either a short circuit or an open circuit as shown in the following figure.

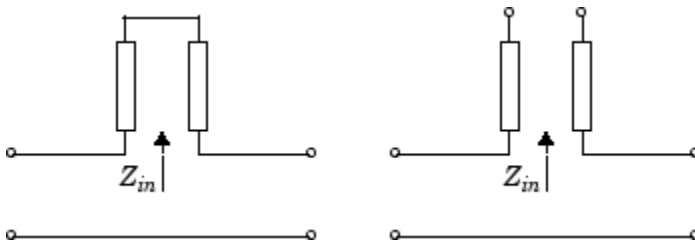

Z_{in} is the input impedance of the series circuit. The ABCD-parameters for the series stub are calculated as:

$$\begin{aligned}
 A &= 1 \\
 B &= Z_{in} \\
 C &= 0 \\
 D &= 1
 \end{aligned}$$

The `analyze` method uses the S-parameters to calculate the group delay values at the frequencies specified in the `analyze` input argument `freq`, as described in the `analyze` reference page.

Examples

```

tx1 = rfckt.twowire;
analyze(tx1,[1e9,2e9,3e9]);
tx1.AnalyzedResult

ans =

```

Name: 'Data object'
Freq: [3x1 double]
S_Parameters: [2x2x3 double]
GroupDelay: [3x1 double]
NF: [3x1 double]
OIP3: [3x1 double]
Z0: 50
ZS: 50
ZL: 50
IntpType: 'Linear'

EpsilonR property

Class: rfckt.twowire

Package: rfckt

Relative permittivity of dielectric

Values

Scalar

Description

The ratio of the permittivity of the dielectric, ϵ , to the permittivity of free space, ϵ_0 . The default value is 2.3.

Examples

```
tx1=rfckt.twowire;  
tx1.EpsilonR=2.7;
```

LineLength property

Class: rfckt.twowire

Package: rfckt

Transmission line length

Values

Scalar

Description

The physical length of the transmission line in meters. The default is 0.01.

Examples

```
tx1 = rfckt.twowire;  
tx1.LineLength = 0.001;
```

LossTangent property

Class: rfckt.twowire

Package: rfckt

Tangent of loss angle

Values

Scalar

Description

The loss angle tangent of the dielectric. The default is 0.

Examples

```
tx1=rfckt.twowire;  
tx1.LossTangent=0.002;
```

MuR property

Class: rfckt.twowire

Package: rfckt

Relative permeability of dielectric

Values

Scalar

Description

The ratio of the permeability of the dielectric, μ , to the permeability of free space, μ_0 . The default value is 1.

Examples

Change the relative permeability of the dielectric:

```
tx1=rfckt.twowire;  
tx1.MuR=0.8;
```

Name property

Class: rfckt.twowire

Package: rfckt

Object name

Values

'Two-Wire Transmission Line'

Description

Read-only string that contains the name of the object.

Examples

```
tx1 = rfckt.twowire;  
tx1.Name
```

```
ans =
```

```
Two-Wire Transmission Line
```

Radius property

Class: rfckt.twowire

Package: rfckt

Wire radius

Values

Scalar

Description

The radius of the conducting wires, in meters. The default is $6.7e-4$.

Examples

```
tx1=rfckt.twowire;  
tx1.Radius=0.0031;
```

Separation property

Class: rfckt.twowire

Package: rfckt

Distance between wires

Values

Scalar

Description

Distance, in meters, separating the wire centers. The default is 0.0016.

Examples

```
tx1=rfckt.twowire;  
tx1.Separation=0.8e-3;
```

SigmaCond property

Class: rfckt.twowire

Package: rfckt

Conductor conductivity

Values

Scalar

Description

Conductivity, in Siemens per meter (S/m), of the conductor. The default is Inf.

Examples

```
tx1=rfckt.twowire;  
tx1.SigmaCond=5.81e7;
```

StubMode property

Class: rfckt.twowire

Package: rfckt

Type of stub

Values

'NotAStub' (default), 'Series', or 'Shunt'

Description

String that specifies what type of stub, if any, to include in the transmission line model.

Examples

```
tx1 = rfckt.twowire;  
tx1.StubMode = 'Series';
```

Termination property

Class: rfckt.twowire

Package: rfckt

Stub transmission line termination

Values

'NotApplicable' (default), 'Open', or 'Short'.

Description

String that specifies what type of termination to use for 'Shunt' and 'Series' stub modes. `Termination` is ignored if the line has no stub. Use 'NotApplicable' when `StubMode` is 'NotAStub'.

Examples

```
tx1 = rfckt.twowire;  
tx1.StubMode = 'Series';  
tx1.Termination = 'Short';
```

nPort property

Class: rfckt.twowire

Package: rfckt

Number of ports

Values

2

Description

A read-only integer that indicates the object has two ports.

Examples

```
tx1 = rfckt.twowire;  
tx1.nPort
```

```
ans =
```

```
2
```

AnalyzedResult property

Class: rfckt.txline

Package: rfckt

Computed S-parameters, noise figure, OIP3, and group delay values

Values

rfdata.data object

Description

Handle to an `rfdata.data` object that contains the S-parameters, noise figure, OIP3, and group delay values computed over the specified frequency range using the `analyze` method. This property is empty by default.

The `analyze` method treats the transmission line, which can be lossy or lossless, as a 2-port linear network. It computes the `AnalyzedResult` property of a stub or as a stubless line using the data stored in the `rfckt.txline` object properties as follows:

- If you model the transmission line as a stubless line, the `analyze` method first calculates the ABCD-parameters at each frequency contained in the modeling frequencies vector. It then uses the `abcd2s` function to convert the ABCD-parameters to S-parameters.

The `analyze` method calculates the ABCD-parameters using the physical length of the transmission line, d , and the complex propagation constant, k , using the following equations:

$$A = \frac{e^{kd} + e^{-kd}}{2}$$
$$B = \frac{Z_0 * (e^{kd} - e^{-kd})}{2}$$
$$C = \frac{e^{kd} - e^{-kd}}{2 * Z_0}$$
$$D = \frac{e^{kd} + e^{-kd}}{2}$$

Z_0 is the specified characteristic impedance. k is a vector whose elements correspond to the elements of the input vector `freq`. The `analyze` method calculates k from the specified properties as $k = \alpha_a + i\beta$, where α_a is the attenuation coefficient and β is the wave number. The attenuation coefficient α_a is related to the specified loss, α , by

$$\alpha_a = -\ln(10^{\alpha/20})$$

The wave number β is related to the specified phase velocity, V_p , by

$$\beta = \frac{2\pi f}{V_p},$$

where f is the frequency range specified in the `analyze` input argument `freq`. The phase velocity V_p is derived from the `rfckt.txline` object properties. It is also known as the *wave propagation velocity*.

- If you model the transmission line as a shunt or series stub, the `analyze` method first calculates the ABCD-parameters at the specified frequencies. It then uses the `abcd2s` function to convert the ABCD-parameters to S-parameters.

When you set the `StubMode` property to 'Shunt', the 2-port network consists of a stub transmission line that you can terminate with either a short circuit or an open circuit as shown in the following figure.

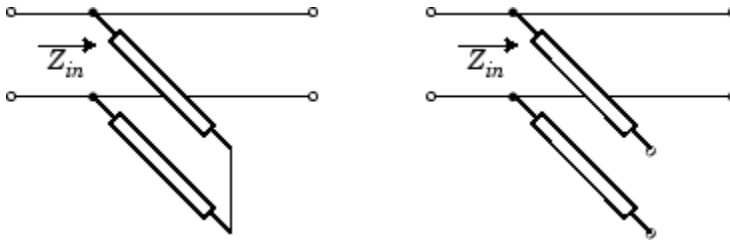

Z_{in} is the input impedance of the shunt circuit. The ABCD-parameters for the shunt stub are calculated as:

$$A = 1$$

$$B = 0$$

$$C = 1 / Z_{in}$$

$$D = 1$$

When you set the **StubMode** property to 'Series', the 2-port network consists of a series transmission line that you can terminate with either a short circuit or an open circuit as shown in the following figure.

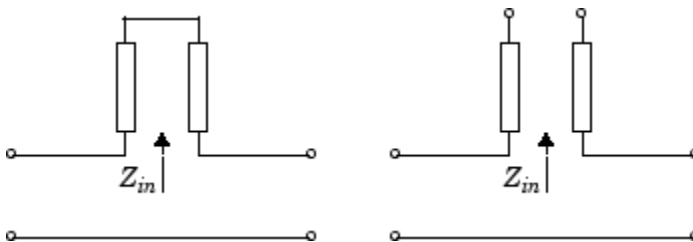

Z_{in} is the input impedance of the series circuit. The ABCD-parameters for the series stub are calculated as:

$$A = 1$$

$$B = Z_{in}$$

$$C = 0$$

$$D = 1$$

The `analyze` method uses the S-parameters to calculate the group delay values at the frequencies specified in the `analyze` input argument `freq`, as described in the `analyze` reference page.

Examples

```
tx1 = rfckt.txline;  
analyze(tx1,[1e9,2e9,3e9]);  
tx1.AnalyzedResult
```

```
ans =
```

```
Name: 'Data object'  
Freq: [3x1 double]  
S_Parameters: [2x2x3 double]  
GroupDelay: [3x1 double]  
NF: [3x1 double]  
OIP3: [3x1 double]  
Z0: 50  
ZS: 50  
ZL: 50  
IntpType: 'Linear'
```

Freq property

Class: rfckt.txline

Package: rfckt

Frequency data

Values

Vector

Description

M-element vector of frequency values in hertz for the loss and phase velocity values in the **LOSS** and **PV** properties. The values must be positive, and the order of the frequencies must correspond to the order of the loss and phase velocity values. This property is empty by default.

Examples

```
f = [2.08 2.10]*1.0e9;  
tx1 = rfckt.txline;  
tx1.Freq = f;
```

IntpType property

Class: rfckt.txline

Package: rfckt

Interpolation method

Values

'Linear' (default), 'Spline', or 'Cubic'

Description

The `analyze` method is flexible in that it does not require the frequencies of the specified S-parameters to match the requested analysis frequencies. If needed, `analyze` applies the interpolation and extrapolation method specified in the `IntpType` property to the specified data to create a new set of data at the requested analysis frequencies. The following table lists the available interpolation methods and describes each one.

Method	Description
Linear (default)	Linear interpolation
Spline	Cubic spline interpolation
Cubic	Piecewise cubic Hermite interpolation

Examples

```
tx1 = rfckt.txline;  
tx1.IntpType = 'cubic';
```

LineLength property

Class: rfckt.txline

Package: rfckt

Transmission line length

Values

Scalar

Description

The physical length of the transmission line in meters. The default is 0.01.

Examples

```
tx1 = rfckt.txline;  
tx1.LineLength = 0.001;
```

Loss property

Class: rfckt.txline

Package: rfckt

Transmission line loss

Values

Vector

Description

M-element vector of line loss values, in decibels per meter, that correspond to the frequencies stored in the **Freq** property. Line loss is the reduction in strength of the signal as it travels over the transmission line, and must be nonnegative. The default is 0.

Examples

```
tx1 = rfckt.txline;  
tx1.Loss = [1.5 3.1]*1e-2;
```

Name property

Class: rfckt.txline

Package: rfckt

Object name

Values

'Transmission Line'

Description

Read-only string that contains the name of the object.

Examples

```
tx1 = rfckt.txline;  
tx1.Name
```

```
ans =
```

```
    Transmission Line
```

PV property

Class: rfckt.txline

Package: rfckt

Phase velocity

Values

Vector

Description

M-element vector of phase velocity values, in meters per second, that correspond to the frequencies stored in the **Freq** property. Propagation velocity of a uniform plane wave on the transmission line. The default is 299792458.

Examples

```
tx1 = rfckt.txline;  
tx1.PV = [1.5 3.1]*1e9;
```

StubMode property

Class: rfckt.txline

Package: rfckt

Type of stub

Values

'NotAStub' (default), 'Series', or 'Shunt'

Description

String that specifies what type of stub, if any, to include in the transmission line model.

Examples

```
tx1 = rfckt.txline;  
tx1.StubMode = 'Series';
```

Termination property

Class: rfckt.txline

Package: rfckt

Stub transmission line termination

Values

'NotApplicable' (default), 'Open', or 'Short'.

Description

String that specifies what type of termination to use for 'Shunt' and 'Series' stub modes. `Termination` is ignored if the line has no stub. Use 'NotApplicable' when `StubMode` is 'NotAStub'.

Examples

```
tx1 = rfckt.txline;  
tx1.StubMode = 'Series';  
tx1.Termination = 'Short';
```

Z0 property

Class: rfckt.txline

Package: rfckt

Characteristic impedance

Values

Vector

Description

Vector of characteristic impedance values, in ohms, that correspond to the frequencies stored in the Freq property. The default is 50 ohms.

Examples

```
tx1 = rfckt.txline;  
tx1.Z0 = 75;
```

nPort property

Class: rfckt.txline

Package: rfckt

Number of ports

Values

2

Description

A read-only integer that indicates the object has two ports.

Examples

```
tx1 = rfckt.txline;  
tx1.nPort
```

```
ans =
```

```
2
```

Freq property

Class: rfdata.data

Package: rfdata

Frequency data

Values

Vector

Description

M-element vector of frequency values in hertz for the S-parameters in the `S_Parameters` property. The values must be positive, and the order of the frequencies must correspond to the order of the S-parameters. This property is empty by default.

Examples

```
f = [2.08 2.10]*1.0e9;  
txdata = rfdata.data;  
txdata.Freq = f;
```

GroupDelay property

Class: rfddata.data

Package: rfddata

Group delay data

Values

Vector

Description

M-element vector of group delay values in seconds that the toolbox calculates at each frequency in the `Freq` property when you call the `analyze` method. This property is empty by default.

IntpType property

Class: rfdata.data

Package: rfdata

Interpolation method

Values

'Linear' (default), 'Spline', or 'Cubic'

Description

The `analyze` method is flexible in that it does not require the frequencies of the specified S-parameters to match the requested analysis frequencies. If needed, `analyze` applies the interpolation and extrapolation method specified in the `IntpType` property to the specified data to create a new set of data at the requested analysis frequencies. The following table lists the available interpolation methods and describes each one.

Method	Description
Linear (default)	Linear interpolation
Spline	Cubic spline interpolation
Cubic	Piecewise cubic Hermite interpolation

Examples

```
txdata = rfdata.data;
txdata.IntpType = 'cubic'
```

```
txdata =
```

```
    Name: 'Data object'
    Freq: []
    S_Parameters: []
    GroupDelay: []
```

NF: 0
OIP3: Inf
Z0: 50
ZS: 50
ZL: 50
IntpType: 'Cubic'

NF property

Class: rfdata.data

Package: rfdata

Noise figure

Values

Scalar

Description

The amount of noise relative to a noise temperature of 290 degrees kelvin, in decibels. The default value of zero indicates a noiseless system.

Examples

```
txdata = rfdata.data;  
txdata.NF=3
```

```
txdata =
```

```
Name: 'Data object'  
Freq: []  
S_Parameters: []  
GroupDelay: []  
NF: 3  
OIP3: Inf  
Z0: 50  
ZS: 50  
ZL: 50  
IntpType: 'Linear'
```

Name property

Class: rfddata.data

Package: rfddata

Object name

Values

'Data object'

Description

Read-only string that contains the name of the object.

Examples

```
txdata = rfddata.data;  
txdata.Name
```

```
ans =
```

```
    Data object
```

OIP3 property

Class: rfddata.data

Package: rfddata

Output third-order intercept point

Values

Scalar

Description

Signal distortion in watts. This property represents the hypothetical output signal level at which the third-order tones would reach the same amplitude level as the desired input tones. The default is Inf.

Note: If you set NonLinearData using `rfddata.ip3` or `rfddata.power`, then the property is converted from scalar OIP3 format to the format of `rfddata.ip3` or `rfddata.power`.

Examples

```
txdata = rfddata.data;  
txdata.OIP3 = 30;
```

S_Parameters property

Class: rfdata.data

Package: rfdata

S-parameter data

Values

Description

2-by-2-by-M array of S-parameters of the circuit described by the `rfdata.data` object, where M is the number of frequencies at which the network parameters are specified. The values correspond to the frequencies stored in the `Freq` property. This property is empty by default.

Examples

```
s_vec(:,:,1) = ...
    [-0.724725-0.481324i, -0.685727+1.782660i; ...
     0.000000+0.000000i, -0.074122-0.321568i];
s_vec(:,:,2) = ...
    [-0.731774-0.471453i, -0.655990+1.798041i; ...
     0.001399+0.000463i, -0.076091-0.319025i];
s_vec(:,:,3) = ...
    [-0.738760-0.461585i, -0.626185+1.813092i; ...
     0.002733+0.000887i, -0.077999-0.316488i];
txdata = rfdata.data;
txdata.S_Parameters = s_vec;
```

Z0 property

Class: rfdata.data

Package: rfdata

Reference impedance

Values

Scalar

Description

Scalar reference impedance in ohms. The default is 50 ohms.

Examples

```
txdata = rfdata.data;  
txdata.Z0 = 75;
```

ZL property

Class: rfddata.data

Package: rfddata

Load impedance

Values

Scalar

Description

Scalar load impedance in ohms. The default is 50 ohms.

Examples

```
txdata = rfddata.data;  
txdata.ZL = 75;
```

ZS property

Class: rfdata.data

Package: rfdata

Source impedance

Values

Scalar

Description

Scalar source impedance in ohms. The default is 50 ohms.

Examples

```
txdata = rfdata.data;  
txdata.ZS = 75;
```

Data property

Class: rfddata.ip3

Package: rfddata

Third-order intercept values

Values

Vector

Description

M-element vector of IP3 data, in watts, that corresponds to the frequencies stored in the Freq property. The default is Inf.

Note: If you set NonLinearData using rfddata.ip3 or rfddata.power, then the property is converted from scalar OIP3 format to the format of rfddata.ip3 or rfddata.power.

Examples

Data Property of rfddata.ip3 Object

Create rfddata.ip3 object specified at two frequencies.

```
freq = [1e9 2e0];  
ip3_vec_dbm = [-5.2 7.1];  
ip3_vec_watts = (1e-3)*10.^(ip3_vec_dbm/10); % Convert dbm to watts  
ip3data = rfddata.ip3('Type','OIP3','Data',ip3_vec_watts,'Freq',freq)
```

```
ip3data =
```

```
    rfddata.ip3 with properties:
```

```
    Type: 'OIP3'
```

Freq: [2x1 double]
Data: [2x1 double]
Name: '3rd order intercept'

Freq property

Class: rfddata.ip3

Package: rfddata

Frequency data

Values

Vector

Description

M-element vector of frequency values in hertz for the IP3 data in the `Data` property. The values must be positive, and the order of the frequencies must correspond to the order of the IP3 values. This property is empty by default.

Examples

```
f = [2.08 2.10]*1.0e9;  
ip3data = rfddata.ip3;  
ip3data.Freq = f;
```

Name property

Class: rfddata.ip3

Package: rfddata

Object name

Values

'3rd order intercept'

Description

Read-only string that contains the name of the object.

Examples

```
ip3data = rfddata.ip3;  
ip3data.Name
```

```
ans =
```

```
    3rd order intercept
```

Type property

Class: rfdata.ip3

Package: rfdata

Power reference type

Values

'OIP3' (default) or 'IIP3'

Description

String that indicates whether the specified IP3 data is output or input IP3.

Examples

```
ip3data = rfdata.ip3;  
ip3data.Type
```

```
ans =
```

```
    OIP3
```

Data property

Class: rfddata.mixerspurs

Package: rfddata

Mixer spur power values

Values

Matrix

Description

Matrix of values, in decibels, by which the mixer spur power is less than the power at the fundamental output frequency. Values must be between 0 and 99. This property is empty by default.

Examples

```
spurs = rfddata.mixerspurs...  
        ('Data',[2 5 3; 1 0 99; 10 99 99],...  
         'PinRef',3,'PLORef',5)
```

```
spurs.data
```

```
ans =
```

```
     2     5     3  
     1     0    99  
    10    99    99
```

Name property

Class: rfdata.mixerspur

Package: rfdata

Object name

Values

'Intermodulation table'

Description

Read-only string that contains the name of the object.

Examples

```
spurdata = rfdata.mixerspur;  
spurdata.Name
```

```
ans =
```

```
Intermodulation table
```

PLORef property

Class: rfddata.mixerspur

Package: rfddata

Reference local oscillator power

Values

Scalar

Description

Scalar local oscillator power reference, in decibels relative to one milliwatt. The default is 0.

Examples

```
spurs = rfddata.mixerspur...  
        ('Data',[2 5 3; 1 0 99; 10 99 99],  
         'PinRef',3,'PLORef',5)  
spurs.PLORef
```

```
ans =
```

```
5
```

PinRef property

Class: rfddata.mixerspurs

Package: rfddata

Reference input power

Values

Scalar

Description

Scalar input power reference, in decibels relative to one milliwatt. The default is 0.

Examples

```
spurs = rfddata.mixerspurs...
        ('Data',[2 5 3; 1 0 99; 10 99 99],...
         'PinRef',3,'PLORef',5)
spurs.PinRef

ans =

     3
```

Data property

Class: rfdata.network

Package: rfdata

Network parameter data

Values

Array

Description

2-by-2-by-M array of network parameters, where M is the number of frequencies at which the network parameters are specified. The values correspond to the frequencies stored in the `Freq` property. This property is empty by default.

Examples

```
y(:,:,1) = [-.0090-.0104i, .0013+.0018i; ...  
            -.2947+.2961i, .0252+.0075i];  
y(:,:,2) = [-.0086-.0047i, .0014+.0019i; ...  
            -.3047+.3083i, .0251+.0086i];  
y(:,:,3) = [-.0051+.0130i, .0017+.0020i; ...  
            -.3335+.3861i, .0282+.0110i];
```

```
netdata = rfdata.network;  
netdata.Data=y;
```

Freq property

Class: rfdata.network

Package: rfdata

Frequency data

Values

Vector

Description

M-element vector of frequency values in hertz for the network parameters in the **Data** property. The values must be positive, and the order of the frequencies must correspond to the order of the network parameters. This property is empty by default.

Examples

```
f = [2.08 2.10]*1.0e9;  
netdata = rfdata.network;  
netdata.Freq=f;
```

Name property

Class: rfddata.network

Package: rfddata

Object name

Values

'Network parameters'

Description

Read-only string that contains the name of the object.

Examples

```
netdata=rfddata.network;  
netdata.Name
```

```
ans =
```

```
    Network parameters
```

Type property

Class: rfddata.network

Package: rfddata

Type of network parameters.

Values

'S', 'Y', 'Z', 'ABCD', 'H', 'G', or 'T'

Description

String that indicates whether the rfddata.network object .

Examples

```
netdata=rfddata.network;  
netdata.Type='Y';
```

Z0 property

Class: rfdata.network

Package: rfdata

Reference impedance

Values

Scalar

Description

Scalar reference impedance in ohms. This property is only available when the Type property is set to 'S'. The default is 50 ohms.

Examples

```
netdata=rfdata.network;  
netdata.z0=75;
```

Data property

Class: rfdata.nf

Package: rfdata

Noise figure values

Values

Vector

Description

M-element vector of noise figure data, in dB, that corresponds to the frequencies stored in the `Freq` property. The default is 0.

Examples

```
nf_vec = [1.2 3.1];  
nfdata = rfdata.nf;  
nfdata.Data = nf_vec;
```

Freq property

Class: rfddata.nf

Package: rfddata

Frequency data

Values

Vector

Description

M-element vector of frequency values in hertz for the noise figure data in the **Data** property. The values must be positive, and the order of the frequencies must correspond to the order of the noise figure values. This property is empty by default.

Examples

```
f = [2.08 2.10]*1.0e9;  
nfdata = rfddata.nf;  
nfdata.Freq = f;
```

Name property

Class: rfdata.nf

Package: rfdata

Object name

Values

'Noise figure'

Description

Read-only string that contains the name of the object.

Examples

```
nfddata = rfdata.nf;  
nfddata.Name
```

```
ans =
```

```
    Noise figure
```

FMIN property

Class: rfdata.noise

Package: rfdata

Minimum noise figure data

Values

Vector

Description

M-element vector of minimum noise figure values, in decibels, that correspond to the frequencies stored in the `Freq` property. The default is 1.

Examples

```
fmin = [12.08 13.40];  
noisedata = rfdata.noise;  
noisedata.FMIN = fmin;
```

Freq property

Class: rfdata.noise

Package: rfdata

Frequency data

Values

Vector

Description

M-element vector of frequency values in hertz for the spot noise data in the FMIN, GAMMAOPT, and RN properties. The values must be positive, and the order of the frequencies must correspond to the order of the spot noise values. This property is empty by default.

Examples

```
f = [2.08 2.10]*1.0e9;  
noisedata = rfdata.noise;  
noisedata.Freq = f;
```

GAMMAOPT property

Class: rfdata.noise

Package: rfdata

Optimum source reflection coefficients

Values

Vector

Description

M-element vector of optimum source reflection coefficients that correspond to the frequencies stored in the `Freq` property. The default is 1.

Examples

```
gopt = [0.2484-1.2102j 1.0999-0.9295j];  
noisedata = rfdata.noise;  
noisedata.GAMMAOPT = gopt;
```

Name property

Class: rfdata.noise

Package: rfdata

Object name

Values

'Spot noise data'

Description

Read-only string that contains the name of the object.

Examples

```
noisedata = rfdata.noise;  
noisedata.Name
```

```
ans =
```

```
    Spot noise data
```

RN property

Class: rfdata.noise

Package: rfdata

Equivalent normalized noise resistance data

Values

Vector

Description

M-element vector of equivalent normalized noise resistance values that correspond to the frequencies stored in the `Freq` property. The default is 1.

Examples

```
rn = [0.26 0.45];  
noisedata = rfdata.noise;  
noisedata.RN = rn;
```

Freq property

Class: rfdata.power

Package: rfdata

Frequency data

Values

Vector

Description

M-element vector of frequency values in hertz for the power data in the **Phase**, **Pin**, and **Pout** properties. The values must be positive, and the order of the frequencies must correspond to the order of the phase and power values. This property is empty by default.

Examples

```
f = [2.08 2.10]*1.0e9;  
powerdata = rfdata.power;  
powerdata.Freq = f;
```

Name property

Class: rfddata.power

Package: rfddata

Object name

Values

'Power data'

Description

Read-only string that contains the name of the object.

Examples

```
powerdata = rfddata.power;  
powerdata.Name
```

```
ans =
```

```
    Power data
```

Phase property

Class: rfdata.power

Package: rfdata

Phase shift data

Values

Cell

Description

M-element cell of phase shift values, in degrees, where each element corresponds to a frequency stored in the `Freq` property. The values within each element correspond to the input power values stored in the `Pin` property. The default is 1.

Examples

```
phase = {[27.1 35.3],[15.4 19.3 21.1]};  
powerdata = rfdata.power;  
powerdata.Phase = phase;
```

Pin property

Class: rfdata.power

Package: rfdata

Input power data

Values

Cell

Description

M-element cell of input power values, in watts, where each element corresponds to a frequency stored in the **Freq** property. For example,

```
Pin = {[A]; [B]; [C]};
```

where **A**, **B**, and **C** are column vectors that contain the **Pin** values at the first three frequencies stored in the **Freq** property. The default is 1.

Examples

```
pin = {[0.001 0.002],[0.001 0.005 0.01]};  
powerdata = rfdata.power;  
powerdata.Pin = pin;
```

Pout property

Class: rfdata.power

Package: rfdata

Output power data

Values

Cell

Description

M-element cell of output power values, in watts, where each element corresponds to a frequency stored in the **Freq** property. The values within each element correspond to the input power values stored in the **Pin** property. The default is 1.

Examples

```
pout = {[0.0025 0.0031],[0.0025 0.0028 0.0028]};  
powerdata = rfdata.power;  
powerdata.Pout = pout;
```

A property

Class: rfmodel.rational

Package: rfmodel

Poles of rational function object

Values

Vector

Description

Complex vector containing poles of the rational function in radians per second. Its length, shown in

$$F(s) = \left(\sum_{k=1}^n \frac{C_k}{s - A_k} + D \right) e^{-s\tau}, \quad s = j2\pi f$$

as `n`, must be equal to the length of the vector you provide for '`C`'. `n` is the number of poles in the rational function object. This property is empty by default.

Examples

```
rat = rfmodel.rational;  
rat.A = [-0.0532 + 1.3166i; -0.0532 - 1.3166i]*1e10;
```

C property

Class: rfmodel.rational

Package: rfmodel

Residues of rational function object

Values

Vector

Description

Complex vector containing residues of the rational function object in radians per second. Its length, shown in

$$F(s) = \left(\sum_{k=1}^n \frac{C_k}{s - A_k} + D \right) e^{-s\tau}, \quad s = j2\pi f$$

as `n`, must be equal to the length of the vector you provide for 'A'. `n` is the number of residues in the rational function object. This property is empty by default.

Examples

```
rat = rfmodel.rational;  
rat.C = [4.4896 - 4.5025i; 4.4896 + 4.5025i]*1e9;
```

D property

Class: rfmodel.rational

Package: rfmodel

Frequency response offset

Values

Scalar

Description

Scalar value specifying the constant offset in the frequency response of the rational function object. The default is 0.

Examples

```
rat = rfmodel.rational;  
rat.D = 1e-3;
```

Delay property

Class: rfmodel.rational

Package: rfmodel

Frequency response time delay

Values

Scalar

Description

Scalar value specifying the time delay, in seconds, in the frequency response of the rational function object. The default is 0.

Examples

```
rat = rfmodel.rational;  
rat.Delay = 1e-9;
```

Name property

Class: rfmodel.rational

Package: rfmodel

Object name

Values

'Rational Function'

Description

Read-only string that contains the name of the object.

Examples

```
rat = rfmodel.rational;  
rat.Name
```

```
ans =
```

```
    Rational Function
```

Methods — Alphabetical List

addMixer

Add mixer to multiband transmitter or receiver for IF planning analysis

Syntax

```
addMixer(hif,imt,rfcf,rfbw,injection,newIFBW)
```

Description

`addMixer(hif,imt,rfcf,rfbw,injection,newIFBW)` adds a mixer to a multiband transmitter or receiver object `hif` as part of an intermediate-frequency (IF) planning analysis workflow.

Input Arguments

hif

Specify the handle of the `OpenIF` object.

imt

Provide the intermodulation table (IMT) for the mixer as a matrix of real numbers. Each entry in the intermodulation table is a number between 0 and 99. The matrix must be 2-by-2 or larger, and `imt(2,2)` must equal 0.

rfcf

Specify the RF center frequency of the mixer in Hz.

rfbw

Specify the RF bandwidth of the mixer in Hz.

injection

Specify the mixer type. The available values for `injection` change depending on the setting of `hif.IFLocation`.

When `hif.IFLocation` is `'MixerOutput'`, the available values for injection are as follows.

- `'low'` — The LO frequency is less than the RF (low-side injection).
- `'high'` — The LO frequency is greater than the RF (high-side injection).

When `hif.IFLocation` is `'MixerInput'`, the available values for injection are as follows.

- `'sum'` — The RF signal is the sum of the LO frequency and the IF.
- `'diff'` — The RF signal is the difference between the LO frequency and the IF.

newIFBW

Specify the IF bandwidth in Hz after mixing. Use this argument if the IF bandwidth before mixing (defined by the `hif.IFBW` property) is different from the bandwidth after mixing.

Examples

- The `OpenIF` class reference page contains an example that shows how to find the spur-free zones of a multiband receiver with three mixers.
- The example `Finding Free IF Bandwidths` shows how to use information from a spur graph to design a multiband receiver with spur-free zones.

See Also

`getSpurData` | `getSpurFreeZoneData` | `report` | `show` | `OpenIF`

analyze

Analyze circuit object in frequency domain

Syntax

```
analyze(h, freq)
analyze(h, freq, z1, zs, zo, aperture)
analyze(h, freq, 'condition1', value1, ..., 'conditionm', valuem)
```

Description

`analyze(h, freq)` calculates the following circuit data at the specified frequency values:

- Circuit network parameters
- Noise figure
- Output third-order intercept point
- Power data
- Phase noise
- Voltage standing-wave ratio
- Power gain
- Group delay
- Reflection coefficients
- Stability data
- Transfer function

`h` is the handle of the circuit object to be analyzed. `freq` is a vector of frequencies, specified in hertz, at which to analyze the circuit. OIP_3 is always infinite for passive circuits.

`analyze(h, freq, z1, zs, zo, aperture)` calculates the circuit data at the specified frequency values. The arguments `z1`, `zs`, `zo`, and `aperture` are optional. `z1`, `zs`, and `zo`

represent the circuit load, circuit source, and reference impedances of the S-parameters, respectively. The default value of all these arguments is 50 ohms.

Note: When you specify impedance values, the `analyze` method changes the object's values to match your specification.

The `aperture` argument determines the two frequency points that the `analyze` method uses to compute the group delay for each frequency in `freq`. `aperture` can be a positive scalar or a vector of the same length of as `freq`.

Note: For `rfckt.datafile`, `rfckt.passive`, `rfckt.amplifier`, and `rfckt.mixer` objects that contain measured S-parameter data, the `analyze` method uses the two nearest measurement points to compute the group delay, regardless of the value of `aperture`.

Group delay τ_g at each frequency point f is the negative slope of the phase angle of S_{21} with respect to f :

$$\tau_g(f) = -\frac{\Delta\phi}{\Delta\omega} = -\frac{\arg(S_{21}(f_+)) - \arg(S_{21}(f_-))}{2\pi(f_+ - f_-)}$$

where:

- f_+ is:
 - $f(1 + \text{aperture}/2)$ for `aperture` < 1.
 - $f + \text{aperture}/2$ for `aperture` ≥ 1.

If f is the maximum value of `freq`, then $f_+ = f$.

- f_- is:
 - $f(1 - \text{aperture}/2)$ for `aperture` < 1.
 - $f - \text{aperture}/2$ for `aperture` ≥ 1.

If f is the minimum value of `freq`, then $f_- = f$.

By default, `analyze` calculates the group delay in nanoseconds.

The value of `aperture` affects the accuracy of the computed group delay. If `aperture` is too large, the slope estimate may be not accurate. If `aperture` is too small, the computer numerical error may affect the accuracy of the group delay result.

`analyze(h, freq, 'condition1', value1, ..., 'conditionm', valuem)` calculates the circuit data at the specified frequency values and operating conditions for the object `h`. The inputs `'condition1', value1, ..., 'conditionm', valuem` are the condition/value pairs at which to analyze the object. Use this syntax for `rfckt.amplifier`, `rfckt.mixer`, and `rfdata.data` objects where the condition/value pairs are operating conditions from a `.p2d` or `.s2d` file.

Note: When you specify condition/value pairs, the `analyze` method changes the object's values to match your specification.

When you analyze a network that contains several objects, RF Toolbox software does not issue an error or warning if the specified conditions cannot be applied to all objects. For some networks, because there is no error or warning, you can call the `analyze` method once to apply the same set of operating conditions to any objects where operating conditions are applicable. However, you may want to analyze a network that contains one or more of the following:

- Several objects with different sets of operating conditions.
- Several objects with the same set of operating conditions that are configured differently.

To analyze such a network, you should use the `setop` method to configure the operating conditions of each individual object before analyzing the network.

Analysis of Circuit Objects

For most circuit objects, the `AnalyzedResult` property is empty until the `analyze` method is applied to the circuit object. However, the following four circuit objects are the exception to this rule:

- `rfckt.datafile` — By default, the `AnalyzedResult` property of `rfckt.datafile` objects contains the S-parameter, noise figure, and group delay values that are calculated over the network parameter frequencies in the `passive.s2p` data file. OIP3 is ∞ by default because the data in `passive.s2p` is passive.

- `rfckt.passive` — By default, the `AnalyzedResult` property of `rfckt.passive` objects contains the S-parameter, noise figure, and group delay values that are the result of analyzing the values stored in the `passive.s2p` file at the frequencies stored in this file. These frequency values are also stored in the `NetworkData` property. OIP3 is always ∞ for `rfckt.passive` objects because the data is passive.
- `rfckt.amplifier` — By default, the `AnalyzedResult` property of `rfckt.amplifier` objects contains the S-parameter, noise figure, OIP3, and group delay values that result from analyzing the values stored in the `default.amp` file at the frequencies stored in this file. These frequency values are also stored in the `NetworkData` property.
- `rfckt.mixer` — By default, the `AnalyzedResult` property of `rfckt.mixer` objects contains the S-parameter, noise figure, OIP3, and group delay values that result from analyzing the values stored in the `default.s2p` file at the frequencies stored in this file. These frequency values are also stored in the `NetworkData` property.

For a detailed explanation of how the `analyze` method calculates the network parameters, noise figure values, and OIP3 values for a particular object, see the `AnalyzedResult` property on the reference page for that object.

References

<http://www.microwaves101.com/encyclopedia/groupdelaymeasurements.cfm>

See Also

`calculate` | `extract` | `getz0` | `listformat` | `listparam` | `loglog` | `plot` | `plotyy` | `polar` | `semilogx` | `semilogy` | `smith` | `read` | `restore` | `write`

calculate

Calculate specified parameters for circuit object

Syntax

```
[data,params,freq] = calculate(h,'parameter1',...,'parameterN',  
'format')  
[ydata,params,xdata] = calculate(h,'parameter1',...,'parameterN',  
'format',xparameter,xformat,  
'condition1',value1,...,'conditionM',valuem, 'freq',freq,'pin',pin)
```

Description

`[data,params,freq] = calculate(h,'parameter1',...,'parameterN', 'format')` calculates the specified parameters for the object `h` and returns them in the `n`-element cell array `data`.

The input `h` is the handle of a circuit object.

`parameter1, ..., parameterN` is the list of parameters to be calculated. Use the `listparam` method to get a list of the valid parameters for a circuit object.

`format` is the format of the output `data`. The format determines if RF Toolbox software converts the parameter values to a new set of units, or operates on the components of complex parameter values.

For example:

- Specify `format` as `Real` to compute the real part of the selected parameter.
- Specify `format` as `'none'` to return the parameter values unchanged.

Use the `listformat` method to get a list of the valid formats for a particular parameter.

The output `params` is an `n`-element cell array containing the names, as strings, of the parameters in `data`. `freq` is a vector of frequencies at which the parameters are known.

Note: Before calling `calculate`, you must use the `analyze` method to perform a frequency domain analysis for the circuit object.

```
[ydata,params,xdata] = calculate(h,'parameter1',...,'parameterN',
'format',xparameter,xformat,
'condition1',value1,...,'conditionM',valuem, 'freq',freq,'pin',pin)
calculates the specified parameters at the specified operating conditions for the object h.
```

`xparameter` is the independent parameter for which to calculate the specified parameters. Several `xparameter` values are available for all objects. When you import `rfckt.amplifier`, `rfckt.mixer`, or `rfdata.data` object specifications from a `.p2d` or `.s2d` file, you can also specify any operating conditions from the file that have numeric values, such as bias.

The following table shows the most commonly available parameters and the corresponding `xparameter` values. The default settings listed in the table are used if `xparameter` is not specified.

Parameter Name	xparameter values
Pout, Phase, LS11, LS12, LS21, LS22	Pin (default), Freq
S11, S12, S21, S22, NF, IIP3, OIP3, GroupDelay, VSWRIn, VSWROut, GammaIn, GammaOut, FMIN, GammaOPT, RN, TF1, TF2, Gt, Ga, Gp, Gmag, Gmsg, GammaMS, GammaML, K, Delta, Mu, MuPrime	Freq
AM/AM, AM/PM	AM (default, and only available value)

`xformat` is the format to use for the specified `xparameter`. No `xformat` specification is needed when `xparameter` is an operating condition.

The following table shows the `xformat` values that are available for the `xparameter` values listed in the preceding table, along with the default settings that are used if `xformat` is not specified.

xparameter values	xformat values
Pin	dBm (default), mW, W, dBW

xparameter values	xformat values
Freq	THz, GHz, MHz, KHz, Hz By default, <code>xformat</code> is chosen to provide the best scaling for the given <code>xparameter</code> values.
AM	Magnitude (decibels) (default), Magnitude (linear)

`condition1, value1, . . . , conditionm, valuem` are the optional condition/value pairs at which to calculate the specified parameters. These pairs are usually operating conditions from a `.p2d` or `.s2d` file. For some parameters, you can specify a set of frequency or input power values at which to calculate the specified parameter.

For example:

- When you calculate large-signal S-parameters as a function of input power, you can specify frequency points of interest using condition/value pairs.
- When you calculate large-signal S-parameters as a function of frequency, you can specify input power levels of interest using condition/value pairs.
- When you calculate parameters as a function of an operating condition, you can specify both frequency and input power values using condition/value pairs.

`freq` is the optional frequency value at which to calculate the specified parameters.

`pin` is the optional input power value at which to calculate the specified parameters.

The method returns the following `n`-element cell arrays:

- `ydata` — The calculated values of the specified parameter.
- `params` — The names, as strings, of the parameters in `xdata` and `ydata`.
- `xdata` — The `xparameter` values at which the specified parameters are known.

Note: For compatibility reasons, if `xdata` contains only one vector or if all `xdata` values are equal, then `xdata` is a numeric vector rather than a cell of a single vector.

If `h` has multiple operating conditions, such as from a `.p2d` or `.s2d` file, the `calculate` method operates as follows:

- If you do not specify any operating conditions as arguments to the `calculate` method, then the method returns the parameter values based on the currently selected operating condition.
- If one or more operating conditions are specified, the `calculate` method returns the parameter values based on those operating conditions.
- When an operating condition is used for the `xparameter` input argument, the `xdata` cell array returned by the `calculate` method contains the operating condition values in ascending order.

Examples

Analyze a general transmission line, `trl`, with the default characteristic impedance of 50 ohms, phase velocity of 299792458 meters per second, and line length of 0.01 meters for frequencies of 1.0 GHz to 3.0 GHz. Then, calculate the S_{11} and S_{22} parameters in decibels.

```
trl = rfckt.txline;
f = [1e9:1.0e7:3e9];
analyze(trl,f);
[data,params,freq] = calculate(trl,'S11','S22','dB')
```

```
data =
    [201x1 double]    [201x1 double]
params =
    'S_{11}'    'S_{22}'
freq = 1.0e+009 *
    1.0000
    1.0100
    1.0200
    ...
```

The `params` output is formatted so you can use it as a plot legend. The first few elements of `data{1}` look like

```
ans =
    1.0e+003 *
    -6.4661
    -0.3372
```

-0.3432
-0.3432
-0.3432
...

See Also

analyze | extract | getz0 | listformat | listparam | loglog | plot | plotyy
| polar | semilogx | semilogy | smith | read | restore | write

circle

Draw circles on Smith chart

Syntax

```
[hlines, hsm] = circle(h, freq, type1, value1, ..., typen, valuen, hsm)
```

Description

`[hlines, hsm] = circle(h, freq, type1, value1, ..., typen, valuen, hsm)` draws the specified circles on a Smith chart and returns the following handles:

- `hlines` — A vector of handles to line objects, with one handle per circle specification.
- `hsm` — The handle to the Smith chart.

The arguments to `circle` are:

- `h` — The handle to an `rfckt` object.
- `freq` — A single frequency point of interest.
- `type1, value1, ..., typen, valuen` — The type/value pairs that specify the circles to plot.

The following table lists the supported circle `type` options and the definition of each option.

type	Definition
'Ga'	Constant available power gain circle
'Gp'	Constant operating power gain circle
'Gt'	Constant transducer power gain circle
'Stab'	Stability circle
'NF'	Constant noise figure circle
'R'	Constant resistance circle

type	Definition
'X'	Constant reactance circle
'G'	Constant conductance circle
'B'	Constant susceptance circle
'Gamma'	Constant reflection magnitude circle

The following table lists the available `value` options for the above types of circles and the definition of each value.

value	Definition
'Ga'	Scalar or vector of gains in dB
'Gp'	Scalar or vector of gains in dB
'Gt'	Scalar or vector of gains in dB
'Stab'	String 'in' or 'source' for input/source stability circle; string 'out' or 'load' for output/load stability circle
'NF'	Scalar or vector of noise figures in dB
'R'	Scalar or vector of normalized resistance
'X'	Scalar or vector of normalized reactance
'G'	Scalar or vector of normalized conductance
'B'	Scalar or vector of normalized susceptance
'Gamma'	Scalar or vector of non-negative reflection magnitude

`hsm` is an optional input argument that you can use to place circles on an existing Smith chart.

Examples

For an example of how to use the `circle` method, see the RF Toolbox example [Designing Matching Networks \(Part 1: Networks with an LNA and Lumped Elements\)](#).

See Also

`smith`

extract

Extract array of network parameters from data object

Syntax

```
[outmatrix, freq] = extract(h,outtype,z0)
```

Description

`[outmatrix, freq] = extract(h,outtype,z0)` extracts the network parameters of `outtype` from an `rfckt`, `rfdata.data` or `rfdata.network` object, `h`, and returns them in `outmatrix`. `freq` is a vector of frequencies that correspond to the network parameters.

`outtype` can be one of these case-insensitive strings 'ABCD_parameters', 'S_parameters', 'Y_parameters', 'Z_parameters', 'H_parameters', 'G_parameters', or 'T_parameters'. `z0` is the reference impedance for the S-parameters. The default is 50 ohms.

See Also

`analyze` | `calculate` | `getz0` | `listformat` | `listparam` | `loglog` | `plot` | `plotyy` | `polar` | `semilogx` | `semilogy` | `smith` | `read` | `restore` | `write`

freqresp

Frequency response of rational function object

Syntax

```
[resp,outfreq] = freqresp(h,infreq)
```

Description

`[resp,outfreq] = freqresp(h,infreq)` computes the frequency response, `resp`, of the rational function object, `h`, at the frequencies specified by `freq`.

The input `h` is the handle of a rational function object returned by `rationalfit`, and `infreq` is a vector of positive frequencies, in Hz, over which the frequency response is calculated.

The output argument `outfreq` is a vector that contains the same frequencies as the input frequency vector, in order of increasing frequency. The frequency response, `resp`, is a vector of frequency response values corresponding to these frequencies. It is computed using the analytical form of the rational function

$$resp = \left(\sum_{k=1}^n \frac{C_k}{s - A_k} + D \right) e^{-s*Delay}, \quad s = j2\pi * freq$$

where `A`, `C`, `D`, and `Delay` are properties of the rational function object, `h`.

Examples

The following example shows you how to compute the frequency response of the data stored in the file `default.s2p` by reading it into an `rfdata` object, fitting a rational function object to the data, and using the `freqresp` method to compute the frequency response of the object.

```
orig_data=read(rfdata.data,'default.s2p')
```

```
freq=orig_data.Freq;
data=orig_data.S_Parameters(2,1,:);
fit_data=rationalfit(freq,data)

[resp,freq]=freqresp(fit_data,freq);

plot(freq/1e9,20*log10(abs(resp)));
figure
plot(freq/1e9,unwrap(angle(resp)));
```

More About

- `rfmodel.rational`

See Also

`rationalfit` | `timeresp` | `writeva`

getop

Display operating conditions

Syntax

```
getop(h)
```

Description

`getop(h)` displays the selected operating conditions for the circuit or data object, `h`.

Information about operating conditions is available only when you import the object specifications from a `.p2d` or `.s2d` file.

Examples

Display the operating conditions of an object:

```
ckt1 = read(rfckt.amplifier, 'default.p2d');  
getop(ckt1)
```

See Also

`setop`

getSpurData

Find spurs in multiband transmitter or receiver frequency space

Syntax

```
spurs = getSpurData(hif)
```

Description

`spurs = getSpurData(hif)` returns a matrix of spur data for the network defined by the `OpenIF` object `hif`. Each spur is a range of frequencies. The two columns of `spurs` contain the endpoints of each spur. The first column contains the lower endpoints and the second column contains the upper endpoints.

Input Arguments

hif — IF (Intermediate Frequency) planning object

`OpenIF` object

IF (Intermediate Frequency) planning object, specified as an `OpenIF` object.

Output Arguments

spurs — Spur data

matrix

Spur data of the network, returned as a matrix. The first column of the matrix contains the lower endpoints of the spur and the second column contains the upper endpoints.

Examples

- The `OpenIF` class reference page contains an example that shows how to find the spur-free zones of a multiband receiver with three mixers.

- The example Finding Free IF Bandwidths shows how to use information from a spur graph to design a multiband receiver with spur-free zones.

See Also

`addMixer` | `report` | `getSpurFreeZoneData` | `OpenIF`

getSpurFreeZoneData

Find spur-free zones in multiband transmitter or receiver frequency space

Syntax

```
zones = getSpurFreeZoneData(hif)
```

Description

`zones = getSpurFreeZoneData(hif)` returns the spur-free zones for the network defined by the `OpenIF` object `hif`. Each zone is a range of IF center frequencies. An IF signal centered in this range does not generate interference in any transmission or reception bands. The two columns of `ZONES` contain the endpoints of each spur-free zone. The first column contains the lower endpoints, and the second column contains the upper endpoints.

Input Arguments

hif — IF (Intermediate Frequency) planning object
`OpenIF` object

IF (Intermediate Frequency) planning object, specified as `OpenIF` object.

Output Arguments

zones — Spur-free zones
matrix

Spur-free zones for the defined network, returned as a matrix. The two columns of the matrix contains the endpoints of each spur free zone.

Alternatives

- The `report` method displays mixer configurations, intermodulation tables, and spur-free zone information at the command line.
- The `show` method generates an interactive spur graph that shows spurious regions and spur-free zones.

Examples

- The `OpenIF` class reference page contains an example that shows how to find the spur-free zones of a multiband receiver with three mixers.
- The example `Finding Free IF Bandwidths` shows how to use information from a spur graph to design a multiband receiver with spur-free zones.

See Also

`addMixer` | `getSpurData` | `report` | `show` | `OpenIF`

getz0

Characteristic impedance of transmission line object

Syntax

```
z0 = getz0(h)
```

Description

`z0 = getz0(h)` returns a scalar or vector, `z0`, that represents the characteristic impedance(s) of circuit object `h`. The object `h` can be `rfckt.txline`, `rfckt.rlcgline`, `rfckt.twowire`, `rfckt.parallelplate`, `rfckt.coaxial`, `rfckt.microstrip`, or `rfckt.cpw`.

See Also

`analyze` | `calculate` | `extract` | `listformat` | `listparam` | `loglog` | `plot` | `plotyy` | `polar` | `semilogx` | `semilogy` | `smith` | `read` | `restore` | `write`

impulse

Impulse response for rational function object

Note: `impulse` may be removed in a future release. Use `timeresp` instead.

Syntax

```
[resp,t] = impulse(h,ts,n)
```

Description

`[resp,t] = impulse(h,ts,n)` computes the impulse response, `resp`, of the rational function object, `h`, over the time period specified by `ts` and `n`.

Note: While you can compute the output response for a rational function object by computing the impulse response of the object and then convolving that response with the input signal, this approach is not recommended. Instead, you should use the `timeresp` method to perform this computation because it generally gives a more accurate output signal for a given input signal.

The input `h` is the handle of a rational function object. `ts` is a positive scalar value that specifies the sample time of the computed impulse response, and `n` is a positive integer that specifies the total number of samples in the response.

The vector of time samples of the impulse response, `t`, is computed from the inputs as `t = [0,ts,2*ts,...,(n-1)*ts]`. The impulse response, `resp`, is an `n`-element vector of impulse response values corresponding to these times. It is computed using the analytical form of the rational function

$$resp = \sum_{k=1}^M C_k e^{A_k(t-Delay)} u(t-Delay) + D\delta(t-Delay)$$

where

- A, C, D, and Delay are properties of the rational function object, h.
- M is the number of poles in the rational function object.

Examples

The following example shows you how to compute the impulse response of the data stored in the file `default.s2p` by fitting a rational function object to the data and using the `impulse` method to compute the impulse response of the object.

```
orig_data=read(rfdata.data,'default.s2p')
freq=orig_data.Freq;
data=orig_data.S_Parameters(2,1,:);
fit_data=rationalfit(freq,data)
```

```
[resp,t]=impulse(fit_data,1e-12,1e4);
```

```
plot(t,resp);
```

More About

- `rfmodel.rational`

See Also

`freqresp` | `rationalfit` | `writeeva`

ispassive

Check passivity of scalar rational function object

Syntax

```
result = ispassive(h)
```

Description

`result = ispassive(h)` checks the passivity of the rational function object, `h`, across all frequencies, and returns `result`, a logical value. If `h` is passive, then `result` is 1. If `h` is not passive, then `result` is 0.

Examples

Create a scalar rational function object and check the passivity of the object:

```
% Read a Touchstone data file
ckt = read(rfckt.passive, 'passive.s2p');
% Fit the transfer function into a rational function object
TF = s2tf(ckt.AnalyzedResult.S_Parameters);
TF_Object = rationalfit(ckt.AnalyzedResult.Freq, TF);
% Check the passivity of the rational function object
Is_Passive = ispassive(TF_Object)
```

See Also

`rfmodel.rational` | `rationalfit`

listformat

List valid formats for specified circuit object parameter

Syntax

```
list = listformat(h, 'parameter')
```

Description

`list = listformat(h, 'parameter')` lists the allowable formats for the specified network parameter. The first listed format is the default format for the specified parameter.

In these lists, 'Abs' and 'Mag' are the same as 'Magnitude (linear)', and 'Angle' is the same as 'Angle (degrees)'.

When you plot phase information as a function of frequency, RF Toolbox software unwraps the phase data using the MATLAB `unwrap` function. The resulting plot is only meaningful if the phase data varies smoothly as a function of frequency, as described in the `unwrap` reference page. If your data does not meet this requirement, you must obtain data on a finer frequency grid.

Use the `listparam` method to get the valid parameters of a circuit object.

Note: Before calling `listformat`, you must use the `analyze` method to perform a frequency domain analysis for the circuit object.

Examples

```
trl = rfckt.txline;  
f = [1e9:1.0e7:3e9];  
analyze(trl,f);  
list = listformat(trl,'S11')  
  
list =
```

'dB'
'Magnitude (decibels)'
'Abs'
'Mag'
'Magnitude (linear)'
'Angle'
'Angle (degrees)'
'Angle (radians)'
'Real'
'Imag'
'Imaginary'

See Also

analyze | calculate | extract | getz0 | listparam | loglog | plot | plotyy |
polar | semilogx | semilogy | smith | read | restore | write

listparam

List valid parameters for specified circuit object

Syntax

```
list = listparam(h)
```

Description

`list = listparam(h)` lists the valid parameters for the specified circuit object `h`.

Note: Before calling `listparam`, you must use the `analyze` method to perform a frequency domain analysis for the circuit object.

Several parameters are available for all objects. When you import `rfckt.amplifier`, `rfckt.mixer`, or `rfdata.data` object specifications from a `.p2d` or `.s2d` file, the list of valid parameters also includes any operating conditions from the file that have numeric values, such as bias.

The following table describes the most commonly available parameters.

Parameter	Description
S11, S12, S21, S22	S-parameters
LS11, LS12, LS21, LS22 (Amplifier and mixer objects with multiple operating conditions only)	
GroupDelay	Group delay
GammaIn, GammaOut	Input and output reflection coefficients
VSWRIn, VSWROut	Input and output voltage standing-wave ratio
IIP3, OIP3 (Amplifier and mixer objects only)	Third-order intercept point

Parameter	Description
NF	Noise figure
TF1	Ratio of the load voltage to the output voltage of the source when the input port is conjugate matched
TF2	Ratio of load voltage to the source voltage
<ul style="list-style-type: none"> • Gt • Ga • Gp • Gmag • Gmsg 	<ul style="list-style-type: none"> • Transducer power gain • Available power gain • Operating power gain • Maximum available power gain • Maximum stable gain
GammaMS, GammaML	Source and load reflection coefficients for simultaneous conjugate match
K, Mu, MuPrime	Stability factor
Delta	Stability condition

Examples

The following examples show you how to list the parameters for a transmission line object.

```
tr1 = rfckt.txline;
f = [1e9:1.0e7:3e9];
analyze(tr1,f);
list = listparam(tr1)
```

See Also

analyze | calculate | extract | getz0 | listformat | loglog | plot | plotyy
| polar | semilogx | semilogy | smith | read | restore | write

loglog

Plot specified circuit object parameters using log-log scale

Syntax

```
lineseries = loglog(h,parameter)
lineseries = loglog(h,parameter1,...,parametern)
lineseries = loglog(h,parameter1,...,parametern,format)
lineseries = loglog(h,'parameter1',...,'parametern',
format,xparameter,xformat,'condition1',value1,...,
'conditionm',valuem,'freq',freq,'pin',pin)
```

Description

`lineseries = loglog(h,parameter)` plots the specified `parameter` in the default format using a log-log scale. `h` is the handle of a circuit (`rfckt`) object.

Type `listparam(h)` to get a list of valid parameters for a circuit object, `h`. Type `listformat(h,parameter)` to see the legitimate formats for a specified parameter. The first listed format is the default for the specified parameter.

The `loglog` method returns a column vector of handles to `lineseries` objects, one handle per line. This output is the same as the output returned by the MATLAB `loglog` method.

`lineseries = loglog(h,parameter1,...,parametern)` plots the parameters `parameter1, ..., parametern` from the object `h` on an X-Y plane using logarithmic scales for both the *x*- and *y*- axes.

`lineseries = loglog(h,parameter1,...,parametern,format)` plots the parameters `parameter1, ..., parametern` in the specified format. `format` is the format of the data to be plotted, e.g. 'Magnitude (decibels)'.

Note: For all circuit objects except those that contain data from a data file, you must perform a frequency domain analysis with the `analyze` method before calling `loglog`.

Use the Property Editor (`propertyeditor`) or the MATLAB `set` function to change Chart Line Properties. The reference pages for MATLAB functions such as `figure`, `axes`, and `text` also list available properties and provide links to more complete property descriptions.

Note: Use the MATLAB `loglog` function to create a log-log scale plot of parameters that are specified as vector data and are not part of a circuit (`rfckt`) object or data (`rfddata`) object.

```
lineseries = loglog(h, 'parameter1', ..., 'parameterN',
format, xparameter, xformat, 'condition1', value1, ...,
'conditionM', valueM, 'freq', freq, 'pin', pin) plots the specified parameters at
the specified operating conditions for the object h.
```

`xparameter` is the independent variable to use in plotting the specified parameters. Several `xparameter` values are available for all objects. When you import `rfckt.amplifier`, `rfckt.mixer`, or `rfddata.data` object specifications from a `.p2d` or `.s2d` file, you can also specify any operating conditions from the file that have numeric values, such as bias.

The following table shows the most commonly available parameters and the corresponding `xparameter` values. The default settings listed in the table are used if `xparameter` is not specified.

Parameter Name	xparameter values
Pout, Phase, LS11, LS12, LS21, LS22	Pin (default), Freq
S11, S12, S21, S22, NF, IIP3, OIP3, GroupDelay, VSWRIn, VSWROut, GammaIn, GammaOut, FMIN, GammaOPT, RN, TF1, TF2, Gt, Ga, Gp, Gmag, Gmsg, GammaMS, GammaML, K, Delta, Mu, MuPrime	Freq
AM/AM, AM/PM	AM

`xformat` is the format to use for the specified `xparameter`. No `xformat` specification is needed when `xparameter` is an operating condition.

The following table shows the `xformat` values that are available for the `xparameter` values listed in the preceding table, along with the default settings that are used if `xformat` is not specified.

xparameter values	xformat values
Pin	dBm (default), mW, W, dBW
Freq	THz, GHz, MHz, KHz, Hz By default, <code>xformat</code> is chosen to provide the best scaling for the given <code>xparameter</code> values.
AM	Magnitude (decibels) (default), Magnitude (linear)

`condition1,value1, . . . , conditionm,valuem` are the optional condition/value pairs at which to plot the specified parameters. These pairs are usually operating conditions from a `.p2d` or `.s2d` file. For some parameters, you can specify a set of frequency or input power values at which to plot the specified parameter.

For example:

- When plotting large-signal S-parameters as a function of input power, you can specify frequency points of interest using condition/value pairs.
- When plotting large-signal S-parameters as a function of frequency, you can specify input power levels of interest using condition/value pairs.
- When plotting parameters as a function of an operating condition, you can specify both frequency and input power values using condition/value pairs.

`freq` is the optional frequency value, in hertz, at which to plot the specified parameters.

`pin` is the optional input power value, in dBm, at which to plot the specified parameters.

If `h` has multiple operating conditions, such as from a `.p2d` or `.s2d` file, the `loglog` method operates as follows:

- If you do not specify any operating conditions as arguments to the `loglog` method, then the method plots the parameter values based on the currently selected operating condition.
- If you specify one or more operating conditions, the `loglog` method plots the parameter values based on those operating conditions.

- When you use an operating condition for the `xparameter` input argument, the method plots the parameters for all operating condition values.

See Also

`analyze` | `calculate` | `extract` | `getz0` | `listformat` | `listparam` | `plot` | `plotyy` | `polar` | `read` | `restore` | `semilogx` | `semilogy` | `smith` | `write`

plot

Plot specified circuit object parameters on X-Y plane

Syntax

```
lineseries = plot(h,parameter)
lineseries = plot(h,parameter1,...,parametern)
lineseries = plot(h,parameter1,...,parametern,format)
lineseries = plot(h,'parameter1',...,'parametern',
format,xparameter,xformat, 'condition1',value1,...,
'conditionm',valuem,'freq',freq,'pin',pin)
lineseries = plot(h,'budget',...)
lineseries = plot(h,'mixerspurspur',k,pin,fin)
```

Description

`lineseries = plot(h,parameter)` plots the specified `parameter` on an X-Y plane in the default format. `h` is the handle of a circuit (`rfckt`) object. Use the `listparam` method to get a list of the valid parameters for a particular circuit object, `h`.

The `plot` method returns a column vector of handles to `lineseries` objects, one handle per line. This output is the same as the output returned by the MATLAB `plot` function.

`lineseries = plot(h,parameter1,...,parametern)` plots the specified parameters `parameter1,..., parametern` from the object `h` on an X-Y plane.

`lineseries = plot(h,parameter1,...,parametern,format)` plots the specified parameters `parameter1,..., parametern` in the specified format. The format determines if RF Toolbox software converts the parameter values to a new set of units, or operates on the components of complex parameter values. For example:

- Specify `format` as `Real` to plot the real part of the selected parameter.
- Specify `format` as `'none'` to plot the parameter values unchanged.

Use the `listformat` method to get a list of the valid formats for a particular parameter.

```
lineseries = plot(h,'parameter1',...,'parametern',
format,xparameter,xformat, 'condition1',value1,...,
```

'conditionm', valuem, 'freq', freq, 'pin', pin) plots the specified parameters at the specified operating conditions for the object h.

xparameter is the independent variable to use in plotting the specified parameters. Several xparameter values are available for all objects. When you import rfckt.amplifier, rfckt.mixer, or rfdata.data object specifications from a .p2d or .s2d file, you can also specify any operating conditions from the file that have numeric values, such as bias.

The following table shows the most commonly available parameters and the corresponding xparameter values. The default settings listed in the table are used if xparameter is not specified.

Parameter Name	xparameter values
Pout, Phase, LS11, LS12, LS21, LS22	Pin (default), Freq
S ₁₁ , S ₁₂ , S ₂₁ , S ₂₂ , S _{ij} , NF, IIP3, OIP3, GroupDelay, VSWRIn, VSWROut, GammaIn, GammaOut, FMIN, GammaOPT, RN, TF1, TF2, Gt, Ga, Gp, Gmag, Gmsg, GammaMS, GammaML, K, Delta, Mu, MuPrime	Freq
AM/AM, AM/PM	AM

xformat is the format to use for the specified xparameter. No xformat specification is needed when xparameter is an operating condition.

The following table shows the xformat values that are available for the xparameter values listed in the preceding table, along with the default settings that are used if xformat is not specified.

xparameter values	xformat values
Pin	dBm (default), mW, W, dBW
Freq	THz, GHz, MHz, KHz, Hz By default, xformat is chosen to provide the best scaling for the given xparameter values.
AM	Magnitude (decibels) (default), Magnitude (linear)

`condition1, value1, ..., conditionm, valuem` are the optional condition/value pairs at which to plot the specified parameters. These pairs are usually operating conditions from a `.p2d` or `.s2d` file. For some parameters, you can specify a set of frequency or input power values at which to plot the specified parameter.

For example:

- When plotting large-signal S-parameters as a function of input power, you can specify frequency points of interest using condition/value pairs.
- When plotting large-signal S-parameters as a function of frequency, you can specify input power levels of interest using condition/value pairs.
- When plotting parameters as a function of an operating condition, you can specify both frequency and input power values using condition/value pairs.

`freq` is the optional frequency value, in hertz, at which to plot the specified parameters.

`pin` is the optional input power value, in dBm, at which to plot the specified parameters.

If `h` has multiple operating conditions, such as from a `.p2d` or `.s2d` file, the `plot` method operates as follows:

- If you do not specify any operating conditions as arguments to the `plot` method, then the method plots the parameter values based on the currently selected operating condition.
- If you specify one or more operating conditions, the `plot` method plots the parameter values based on those operating conditions.
- When you use an operating condition for the `xparameter` input argument, the method plots the parameters for all operating condition values.

`lineseries = plot(h, 'budget', ...)` plots budget data for the specified parameters `parameter1, ..., parameterN` from the `rfckt.cascade` object `h`.

The following table summarizes the parameters and formats that are available for a budget plot.

Parameter	Format
S_{11} , S_{12} , S_{21} , S_{22} , S_{ij}	Magnitude (decibels) Magnitude (linear) Angle (degrees) Real

Parameter	Format
	Imaginary
OIP3	dBm dBW W mW
NF	Magnitude (decibels) Magnitude (linear)

`lineseries = plot(h, 'mixerspurs', k, pin, fin)` plots spur power of an `rfckt.mixer` object or an `rfckt.cascade` object that contains one or more mixers.

`k` is the index of the circuit object for which to plot spur power. Its value can be an integer or 'all'. The default is 'all'. This value creates a budget plot of the spur power for `h`. Use 0 to plot the power at the input of `h`.

`pin` is the optional scalar input power value, in dBm, at which to plot the spur power. The default is 0 dBm. When you create a spur plot for an object, the previous input power value is used for subsequent plots until you specify a different value.

`fin` is the optional scalar input frequency value, in hertz, at which to plot the spur power. If `h` is an `rfckt.mixer` object, the default value of `fin` is the input frequency at which the magnitude of the S_{21} parameter of the mixer, in decibels, is highest. If `h` is an `rfckt.cascade` object, the default value of `fin` is the input frequency at which the magnitude of the S_{21} parameter of the first mixer in the cascade is highest. When you create a spur plot for an object, the previous input frequency value is used for subsequent plots until you specify a different value.

For more information on plotting mixer spur power, see the [Visualizing Mixer Spurs](#) example.

Note: For all circuit objects except those that contain data from a data file, you must perform a frequency domain analysis with the `analyze` method before calling `plot`.

Use the Property Editor (`propertyeditor`) or the MATLAB `set` function to change Chart Line Properties. The reference pages for MATLAB functions such as `figure`, `axes`, and `text` also list available properties and provide links to more complete property descriptions.

Note: Use the MATLAB `plot` function to plot network parameters that are specified as vector data and are not part of a circuit (`rfckt`) object or data (`rfddata`) object.

Alternatives

The `rfplot` function creates magnitude-frequency plots for RF Toolbox S-parameter objects.

See Also

`analyze` | `calculate` | `extract` | `getz0` | `listformat` | `listparam` | `loglog` | `plotyy` | `polar` | `read` | `restore` | `rfplot` | `semilogx` | `semilogy` | `smith` | `write`

plotyy

Plot specified object parameters with y-axes on both left and right sides

Syntax

```
[ax,hlines1,hlines2] = plotyy(h,parameter)
[ax,hlines1,hlines2] = plotyy(h,parameter1,...,parametern)
[ax,hlines1,hlines2] = plotyy(h,parameter,format1,format2)
[ax,hlines1,hlines2] = plotyy(h, parameter1, ..., parametern,
format1, format2)
[ax,hlines1,hlines2] = plotyy(h,parameter1_1,...,parameter1_n1,
format1,parameter2_1,...,parameter2_n2,format2)
[ax,hlines1,hlines2] = plotyy(h,parameter1_1,...,parameter1_n1,
format1,parameter2_1,...,parameter2_n2,format2,xparameter,
xformat,'condition1',value1,...,'conditionm',valuem,
'freq',freq,'pin',pin)
```

Description

`[ax,hlines1,hlines2] = plotyy(h,parameter)` plots the specified `parameter` using the predefined primary and secondary formats for the left and right y-axes, respectively. The formats define how RF Toolbox software displays the data on the plot. `h` is the handle of a circuit (`rfckt`) or an `rfdata.data` object.

- See “Determining Formats” on page 7-43 for a table that shows the predefined primary and secondary formats for the parameters for all circuit and data objects.
- Type `listparam(h)` to get a list of valid parameters for a circuit object, `h`. Type `listformat(h,parameter)` to see the legitimate formats for a specified parameter. The first listed format is the default for the specified parameter.

The `plotyy` method returns the handles to the two axes created in `ax` and the handles to two `lineseries` objects in `hlines1` and `hlines2`.

- `ax(1)` is the left axes.
- `ax(2)` is the right axes.

- `hlines1` is the `lineseries` object for the left y -axis.
- `hlines2` is the `lineseries` object for the right y -axis.

Note: For all circuit objects except those that contain data from a data file, you must perform a frequency domain analysis with the `analyze` method before calling `plotyy`.

Use the Property Editor (`propertyeditor`) or the MATLAB `set` function to change Chart Line Properties. The reference pages for MATLAB functions such as `figure`, `axes`, and `text` also list available properties and provide links to more complete property descriptions.

Note: Use the MATLAB `plotyy` function to plot parameters on two y -axes that are specified as vector data and are not part of a circuit (`rfckt`) object or data (`rfdata`) object.

`[ax,hlines1,hlines2] = plotyy(h,parameter1,...,parameterN)` plots the parameters `parameter1`, ..., `parameterN`. `plotyy` determines the formats for the left and right y -axes based on the predefined primary and secondary formats for the specified parameters, as described in “Determining Formats” on page 7-43.

`[ax,hlines1,hlines2] = plotyy(h,parameter,format1,format2)` plots the specified parameter using `format1` for the left y -axis and `format2` for the right y -axis.

`[ax,hlines1,hlines2] = plotyy(h, parameter1, ..., parameterN, format1, format2)` plots the parameters `parameter1`, ..., `parameterN` on an X-Y plane using `format1` for the left y -axis and `format2` for the right y -axis.

`[ax,hlines1,hlines2] = plotyy(h,parameter1_1,...,parameter1_n1, format1,parameter2_1,...,parameter2_n2,format2)` plots the following data:

- Parameters `parameter1_1`, ..., `parameter1_n1` using `format1` for the left y -axis.
- Parameters `parameter2_1`, ..., `parameter2_n2` using `format2` for the right y -axis.

`[ax,hlines1,hlines2] = plotyy(h,parameter1_1,...,parameter1_n1, format1,parameter2_1,...,parameter2_n2,format2,xparameter, xformat,'condition1',value1,...,'conditionm',valuem,`

'freq', freq, 'pin', pin) plots the specified parameters at the specified operating conditions for the object h.

xparameter is the independent variable to use in plotting the specified parameters. Several xparameter values are available for all objects. When you import rfckt.amplifier, rfckt.mixer, or rfdata.data object specifications from a .p2d or .s2d file, you can also specify any operating conditions from the file that have numeric values, such as bias.

The following table shows the most commonly available parameters and the corresponding xparameter values. The default settings listed in the table are used if xparameter is not specified.

Parameter Name	xparameter values
Pout, Phase, LS11, LS12, LS21, LS22	Pin (default), Freq
S11, S12, S21, S22, NF, IIP3, OIP3, GroupDelay, VSWRIn, VSWROut, GammaIn, GammaOut, FMIN, GammaOPT, RN, TF1, TF2, Gt, Ga, Gp, Gmag, Gmsg, GammaMS, GammaML, K, Delta, Mu, MuPrime	Freq
AM/AM, AM/PM	AM

xformat is the format to use for the specified xparameter. No xformat specification is needed when xparameter is an operating condition.

The following table shows the xformat values that are available for the xparameter values listed in the preceding table, along with the default settings that are used if xformat is not specified.

xparameter values	xformat values
Pin	dBm (default), mW, W, dBW
Freq	THz, GHz, MHz, KHz, Hz By default, xformat is chosen to provide the best scaling for the given xparameter values.
AM	Magnitude (decibels) (default), Magnitude (linear)

`condition1,value1, ..., conditionm,valuem` are the optional condition/value pairs at which to plot the specified parameters. These pairs are usually operating conditions from a `.p2d` or `.s2d` file. For some parameters, you can specify a set of frequency or input power values at which to plot the specified parameter.

For example:

- When plotting large-signal S-parameters as a function of input power, you can specify frequency points of interest using condition/value pairs.
- When plotting large-signal S-parameters as a function of frequency, you can specify input power levels of interest using condition/value pairs.
- When plotting parameters as a function of an operating condition, you can specify both frequency and input power values using condition/value pairs.

`freq` is the optional frequency value, in hertz, at which to plot the specified parameters.

`pin` is the optional input power value, in dBm, at which to plot the specified parameters.

If `h` has multiple operating conditions, such as from a `.p2d` or `.s2d` file, the `plotyy` method operates as follows:

- If you do not specify any operating conditions as arguments to the `plotyy` method, then the method plots the parameter values based on the currently selected operating condition.
- If you specify one or more operating conditions, the `plotyy` method plots the parameter values based on those operating conditions.
- When you use an operating condition for the `xparameter` input argument, the method plots the parameters for all operating condition values.

Determining Formats

When you call `plotyy` without specifying the plot formats for the left and right *y*-axes, `plotyy` determines the formats from the predefined primary and secondary formats for the one or more specified parameters.

This section contains the following topics:

- “Primary and Secondary Formats” on page 7-44

- “Determining Formats for One Parameter” on page 7-45
- “Determining Formats for Multiple Parameters” on page 7-45

Primary and Secondary Formats

The following table shows the primary and secondary formats for the parameters for all circuit and data objects. Use the `listparam` method to list the valid parameters for a particular object. Use the `listformat` method to list valid formats.

Parameter	Primary Format	Secondary Format
S11, S12, S21, S22	Magnitude (decibels)	Angle (Degrees)
LS11, LS12, LS21, LS22	Magnitude (decibels)	Angle (Degrees)
NF	Magnitude (decibels)	
OIP3	dBm	W
Pout	dBm	W
Phase	Angle (Degrees)	
AM/AM	Magnitude (decibels)	
AM/PM	Angle (Degrees)	
GammaIn, GammaOut	Magnitude (decibels)	Angle (Degrees)
Gt, Ga, Gp, Gmag, Gmsg	Magnitude (decibels)	
Delta	Magnitude (decibels)	Angle (Degrees)
TF1, TF2	Magnitude (decibels)	Angle (Degrees)
GammaMS, GammaML	Magnitude (decibels)	Angle (Degrees)
VSWRIn, VSWRout	Magnitude (decibels)	
GroupDelay	ns	
Fmin	Magnitude (decibels)	
GammaOPT	Magnitude (decibels)	Angle (Degrees)
K, Mu, MuPrime	None	
RN	None	
PhaseNoise	dBc/Hz	
NTemp	K	

Parameter	Primary Format	Secondary Format
NFactor	None	

Determining Formats for One Parameter

When you specify only one parameter for plotting, `plotyy` creates the plot as follows:

- The predefined primary format is the format for the left y -axis.
- The predefined secondary format is the format for the right y -axis.

If the specified parameter does not have the predefined secondary format, `plotyy` behaves the same way as `plot`, and does not add a second y -axis to the plot.

Determining Formats for Multiple Parameters

To plot multiple parameters on two y -axes, `plotyy` tries to find two formats from the predefined primary and secondary formats for the specified parameters. To be used in the plot, the formats must meet the following criteria:

- Each format must be a valid format for at least one parameter.
- Each parameter must be plotted at least on one y -axis.

If `plotyy` cannot meet this criteria it issues an error message.

The function uses the following algorithm to determine the two parameters:

- 1 Look up the primary and secondary formats for the specified parameters.
- 2 If one or more pairs of primary-secondary formats meets the preceding criteria for all parameters:
 - Select the pair that applies to the most parameters.
 - Use these formats to create the plot.

Otherwise, proceed to the next step.

- 3 If no pairs of primary-secondary formats meet the criteria for all parameters, try to find one or more pairs of primary-primary formats that meets the criteria. If one or more pairs of primary-primary formats meets the preceding criteria for all parameters:

- Select the pair that applies to the most parameters.
- Use these formats to create the plot.

Otherwise, proceed to the next step.

- 4 If the preceding steps fail to produce a plot, try to find one format from the predefined primary formats. If a primary format is valid for all parameters, use this format to create the plot with the MATLAB `plot` function.

If this is not successful, issue an error message.

The following example shows how `plotyy` applies this criteria to create plots.

Example — Determining Formats for Multiple Parameters

At the MATLAB prompt:

- 1 Type this command to create an `rfckt` object called `amp`:

```
amp = rfckt.amplifier;
```
- 2 Type this command to plot the `S11` and `S21` parameters of `amp` on two *y*-axis:

```
plotyy(amp, 'S11', 'S21')
```

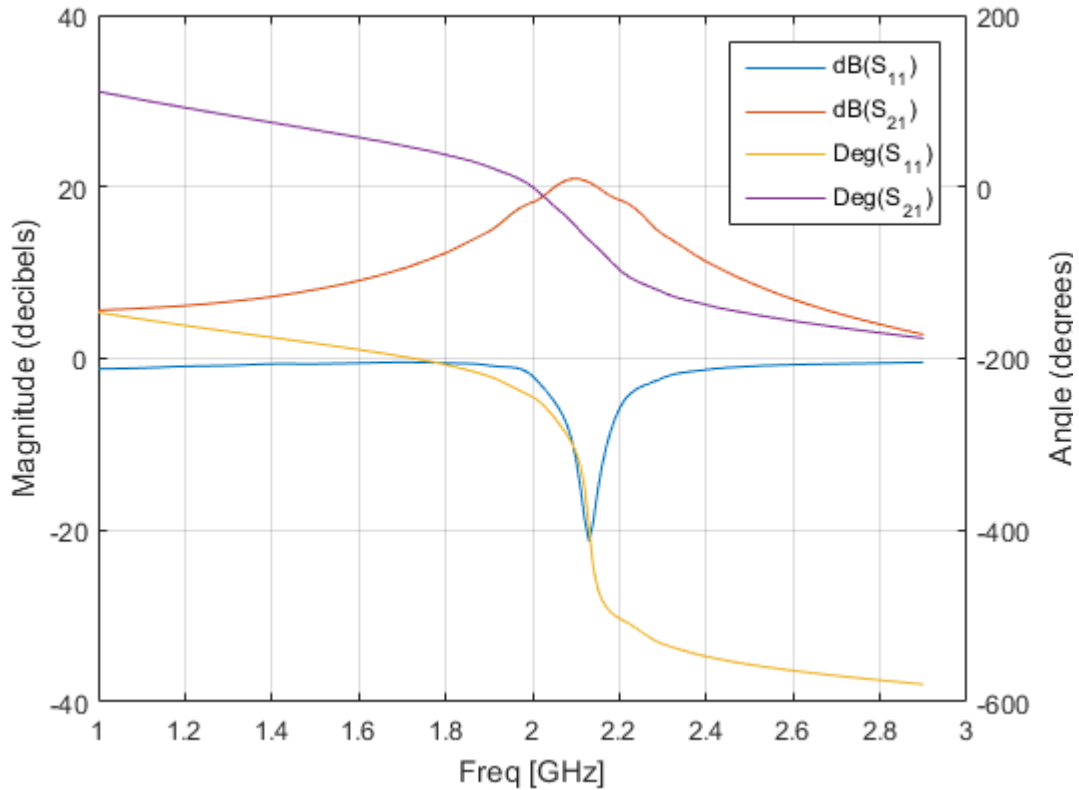
The primary and secondary formats for both S11 and S21 are Magnitude (decibels) and Angle (Degrees), respectively, so plotty uses this primary-secondary format pair to create the plot

- 3 Type this command to plot the S11 and NF parameters of amp on two y-axis:

```
plotty(amp, 'S11', 'NF')
```

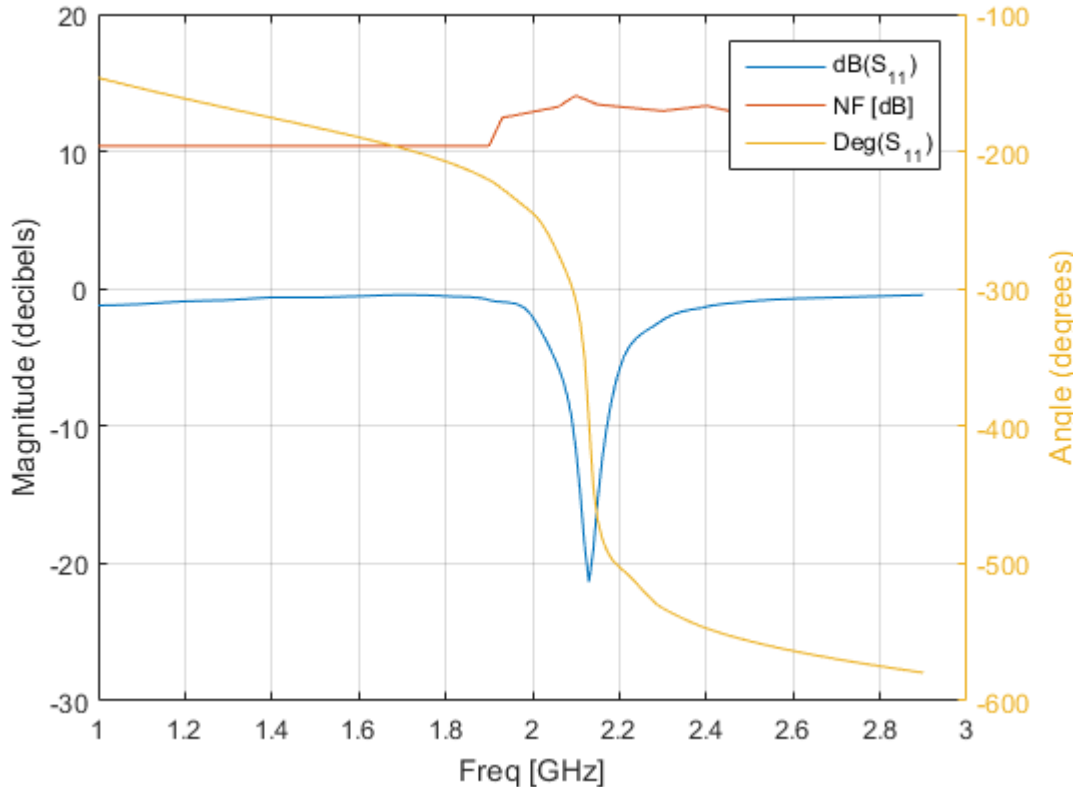

The primary and secondary formats for S_{11} are Magnitude (decibels) and Angle (Degrees), respectively.

- Magnitude (decibels) is a valid format for both S_{11} and NF
- Angle (Degrees) is a valid format for S_{11} .

These formats both meet the preceding criteria, so the function uses this primary-secondary format pair to create the plot.

- 4 Type this command to plot the NF, S_{21} and GroupDelay parameters of amp on two y-axis:

```
plotyy(amp, 'NF', 'S21', 'GroupDelay')
```

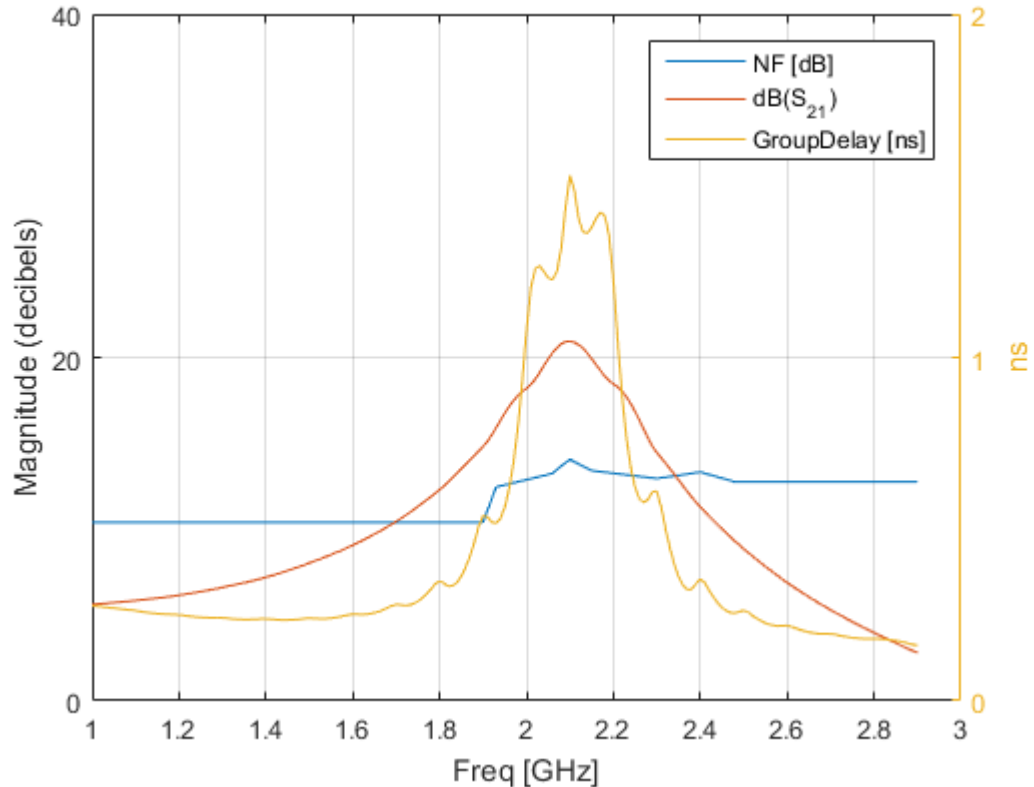

The primary and secondary formats for S_{21} are Magnitude (decibels) and Angle (Degrees), respectively. Both NF and GroupDelay have only a primary format.

- Magnitude (decibels) is the primary format for NF.
- ns is the primary format for GroupDelay.

There is no primary-secondary format pair that meets the preceding criteria, so `plotyy` tries to find a pair of primary formats that meet the criteria. `plotyy` creates the plot using:

- Magnitude (decibels) for the left y-axis.

This format is valid for both NF and S21.

- ns for the right y-axis.

This format is valid for GroupDelay .

These formats meet the criteria.

- 5 Type this command to plot the NFactor and K parameters of amp on two y-axis:

```
plotyy(amp, 'NFactor', 'K')
```

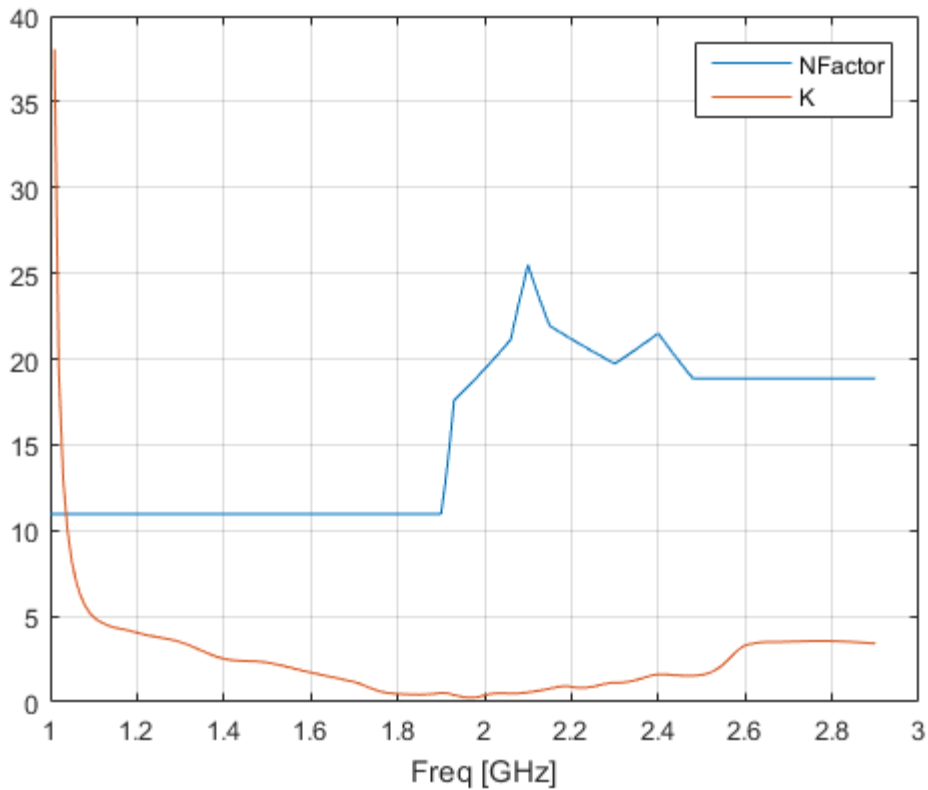

Both NFactor and K have only a primary format, None, so plotyy calls the plot command to create a plot with a single y-axis whose format is None.

- 6 Type this command to plot the NTemp, S21 and NFactor parameters of amp on two y-axes:

```
plotyy(amp, 'NTemp', 'S21', 'NFactor')
```

```
??? Error using ==> rfdata.data.plotyyprocess at 97  
No format specified for input parameters and cannot reconcile  
default formats. Try reducing the number of parameters to plotyy  
and explicitly specifying formats.
```

The primary and secondary formats for S21 are Magnitude (decibels) and Angle (Degrees), respectively. Both NTemp and NFactor have only a primary format.

- Kelvin is the primary format for NTemp.
- None is the primary format for NFactor.

These parameters have no formats in common, so no formats meet the criteria and plotyy issues an error message.

See Also

analyze | calculate | extract | getz0 | listformat | listparam | loglog | plot | polar | read | restore | semilogx | semilogy | smith | write

polar

Plot specified circuit object parameters on polar coordinates

Syntax

```
lineseries = polar(h,'parameter1',...,'parameterN')  
lineseries = polar(h,'parameter1',...,'parameterN',  
xparameter,xformat,'condition1',value1,..., 'conditionM',valuem,  
'freq',freq,'pin',pin)
```

Description

`lineseries = polar(h,'parameter1',...,'parameterN')` plots the parameters `parameter1`, ..., `parameterN` from the object `h` on polar coordinates. `h` is the handle of a circuit (`rfckt`) object.

`polar` returns a column vector of handles to `lineseries` objects, one handle per line. This is the same as the output returned by the MATLAB `polar` function.

Type `listparam(h)` to get a list of valid parameters for a circuit object `h`.

Note: For all circuit objects except those that contain data from a data file, you must use the `analyze` method to perform a frequency domain analysis before calling `polar`.

Use the Property Editor (`propertyeditor`) or the MATLAB `set` function to change the Chart Line Properties. The reference pages for MATLAB functions such as `figure`, `axes`, and `text` list available properties and provide links to more complete descriptions.

Note: Use the MATLAB `polar` function to plot parameters that are not part of a circuit (`rfckt`) object, but are specified as vector data.

```
lineseries = polar(h,'parameter1',...,'parameterN',  
xparameter,xformat,'condition1',value1,..., 'conditionM',valuem,
```

'freq', freq, 'pin', pin) plots the specified parameters at the specified operating conditions for the object h.

xparameter is the independent variable to use in plotting the specified parameters. Several xparameter values are available for all objects. When you import rfckt.amplifier, rfckt.mixer, or rfdata.data object specifications from a .p2d or .s2d file, you can also specify any operating conditions from the file that have numeric values, such as bias.

The following table shows the most commonly available parameters and the corresponding xparameter values. The default settings listed in the table are used if xparameter is not specified.

Parameter Name	xparameter values
Pout, Phase, LS11, LS12, LS21, LS22	Pin (default), Freq
S11, S12, S21, S22, NF, OIP3, VSWRIn, VSWROut, GammaIn, GammaOut, FMIN, GammaOPT, RN	Freq
AM/AM, AM/PM	AM

xformat is the format to use for the specified xparameter. No xformat specification is needed when xparameter is an operating condition.

The following table shows the xformat values that are available for the xparameter values listed in the preceding table, along with the default settings that are used if xformat is not specified.

xparameter values	xformat values
Pin	dBm (default), mW, W, dBW
Freq	THz, GHz, MHz, KHz, Hz By default, xformat is chosen to provide the best scaling for the given xparameter values.
AM	Magnitude (decibels) (default), Magnitude (linear)

condition1,value1, ..., conditionm,valuem are the optional condition/value pairs at which to plot the specified parameters. These pairs are usually operating conditions

from a `.p2d` or `.s2d` file. For some parameters, you can specify a set of frequency or input power values at which to plot the specified parameter.

For example:

- When plotting large-signal S-parameters as a function of input power, you can specify frequency points of interest using condition/value pairs.
- When plotting large-signal S-parameters as a function of frequency, you can specify input power levels of interest using condition/value pairs.
- When plotting parameters as a function of an operating condition, you can specify both frequency and input power values using condition/value pairs.

`freq` is the optional frequency value, in hertz, at which to plot the specified parameters.

`pin` is the optional input power value, in dBm, at which to plot the specified parameters.

If `h` has multiple operating conditions, such as from a `.p2d` or `.s2d` file, the `polar` method operates as follows:

- If you do not specify any operating conditions as arguments to the `polar` method, then the method plots the parameter values based on the currently selected operating condition.
- If you specify one or more operating conditions, the `polar` method plots the parameter values based on those operating conditions.
- When you use an operating condition for the `xparameter` input argument, the method plots the parameters for all operating condition values.

See Also

`analyze` | `calculate` | `extract` | `getz0` | `listformat` | `listparam` | `loglog` | `plot` | `plotyy` | `read` | `restore` | `semilogx` | `semilogy` | `smith` | `write`

read

Read RF data from file to new or existing circuit or data object

Syntax

```
h = read(h)
```

```
h = read(rfckt.datafile,filename)
```

```
h = read(rfckt.passive,filename)
```

```
h = read(rfckt.amplifier,filename)
```

```
h = read(rfckt.mixer,filename)
```

```
h = read(rfdata.data,filename)
```

Description

`h = read(h)` prompts you to select a file and then reads the data from that file into the circuit or data object, `h`. You can read data from an `.snp`, `.ynp`, `.znp`, `.hnp`, `.gnp`, or `.amp` file, where `n` is the number of ports. If `h` is an `rfckt.amplifier`, `rfckt.mixer`, or `rfdata.data` object, you can also read data from `.p2d` and `.s2d` files.

For an example of how to use RF Toolbox software to read data from a `.s2d` file, see [Visualizing Mixer Spurs](#).

`h = read(h,filename)` updates `h` with data from the specified file. In this syntax, `h` can be a circuit or data object. `filename` is a string, representing the filename of a `.snp`, `.ynp`, `.znp`, `.hnp`, `.gnp`, or `.amp` file. If `h` is an `rfckt.amplifier`, `rfckt.mixer`, or `rfdata.data` object, `filename` can also represent a `.p2d` or `.s2d` file. For all files, the filename must include the file extension.

`h = read(rfckt.datafile,filename)` creates an `rfckt.datafile` object `h`, reads the RF data from the specified file, and stores it in `h`.

`h = read(rfckt.passive,filename)` creates an `rfckt.passive` object `h`, reads the RF data from the specified file, and stores it in `h`.

`h = read(rfckt.amplifier, filename)` creates an `rfckt.amplifier` object `h`, reads the RF data from the specified file, and stores it in `h`.

`h = read(rfckt.mixer, filename)` creates an `rfckt.mixer` object `h`, reads the RF data from the specified file, and stores it in `h`.

`h = read(rfdata.data, filename)` creates an `rfdata.data` object `h`, reads the RF data from the specified file, and stores it in `h`.

Examples

The following example shows you how to import data from the file `default.amp` into an `rfckt.amplifier` object.

```
ckt_obj=read(rfckt.amplifier, 'default.amp');
```

References

EIA/IBIS Open Forum, “Touchstone File Format Specification,” Rev. 1.1, 2002 (http://www.vhdl.org/pub/ibis/connector/touchstone_spec11.pdf).

See Also

`analyze` | `calculate` | `extract` | `getz0` | `listformat` | `listparam` | `loglog` | `plot` | `plotyy` | `polar` | `restore` | `semilogx` | `semilogy` | `smith` | `write`

report

Summarize mixer configurations and spur-free-zone information for a multiband transmitter or receiver

Syntax

```
report(hif)
```

Description

`report(hif)` displays a summary at the command line of the information contained in the OpenIF object `hif`. The summary contains:

- The IF location.
- The properties of each mixer, including the RF center frequencies, bandwidths, mixing types, and intermodulation tables.
- The spur-free zones.

Each spur-free zone is a range of IF center frequencies. An IF signal centered in this range does not generate interference in any transmission or reception bands.

Input Arguments

hif — IF planning object

OpenIF object

Intermediate frequency planning object, specified as OpenIF object.

Alternatives

- The `getSpurFreeZoneData` returns the endpoints of the spur-free zones in a matrix.
- The `show` method generates an interactive spur graph that shows spurious regions and spur-free zones.

Examples

For an IF-planning example using an `OpenIF` object, see the examples section of the `OpenIF` class reference page.

See Also

`addMixer` | `getSpurData` | `getSpurFreeZoneData` | `show` | `OpenIF`

restore

Restore data to original frequencies

Syntax

```
h = restore(h)
```

Description

`h = restore(h)` restores data in `h` to the original frequencies of `NetworkData` for plotting. Here, `h` can be `rfckt.datafile`, `rfckt.passive`, `rfckt.amplifier`, or `rfckt.mixer`.

See Also

`analyze` | `calculate` | `extract` | `getz0` | `listformat` | `listparam` | `loglog` | `plot` | `plotyy` | `polar` | `semilogx` | `semilogy` | `smith` | `read` | `write`

semilogx

Plot specified circuit object parameters using log scale for x -axis

Syntax

```
lineseries = semilogx(h,parameter)
lineseries = semilogx(h,parameter1,...,parametern)
lineseries = semilogx(h,parameter1,...,parametern,format)
lineseries = semilogx(h,'parameter1',...,'parametern',
format,xparameter,xformat,'condition1',value1,...,
'conditionm',valuem, 'freq',freq,'pin',pin)
```

Description

`lineseries = semilogx(h,parameter)` plots the specified `parameter` in the default format using a logarithmic scale for the x -axis. `h` is the handle of a circuit (`rfckt`) object.

Type `listparam(h)` to get a list of valid parameters for a circuit object, `h`. Type `listformat(h,parameter)` to see the legitimate formats for a specified `parameter`. The first listed format is the default for the specified `parameter`.

The `semilogx` method returns a column vector of handles to `lineseries` objects, one handle per line. This output is the same as the output returned by the MATLAB `semilogx` function.

`lineseries = semilogx(h,parameter1,...,parametern)` plots the parameters `parameter1, ..., parametern` from the object `h` on an X-Y plane using a logarithmic scale for the x -axis.

`lineseries = semilogx(h,parameter1,...,parametern,format)` plots the parameters `parameter1, ..., parametern` in the specified format. `format` is the format of the data to be plotted, e.g. 'Magnitude (decibels)'.

Note: For all circuit objects except those that contain data from a data file, you must perform a frequency domain analysis with the `analyze` method before calling `semilogx`.

Use the Property Editor (`propertyeditor`) or the MATLAB `set` function to change Chart Line Properties. The reference pages for MATLAB functions such as `figure`, `axes`, and `text` also list available properties and provide links to more complete property descriptions.

Note: Use the MATLAB `semilogx` function to create a semi-log scale plot of network parameters that are specified as vector data and are not part of a circuit (`rfckt`) object or data (`rfddata`) object.

`lineseries = semilogx(h,'parameter1',...,'parameterN',
format,xparameter,xformat,'condition1',value1,...,
'conditionM',valueM, 'freq',freq,'pin',pin)` plots the specified parameters at the specified operating conditions for the object `h`.

`xparameter` is the independent variable to use in plotting the specified parameters. Several `xparameter` values are available for all objects. When you import `rfckt.amplifier`, `rfckt.mixer`, or `rfddata.data` object specifications from a `.p2d` or `.s2d` file, you can also specify any operating conditions from the file that have numeric values, such as `bias`.

The following table shows the most commonly available parameters and the corresponding `xparameter` values. The default settings listed in the table are used if `xparameter` is not specified.

Parameter Name	xparameter values
Pout, Phase, LS11, LS12, LS21, LS22	Pin (default), Freq
S11, S12, S21, S22, NF, IIP3, OIP3, GroupDelay, VSWRIn, VSWROut, GammaIn, GammaOut, FMIN, GammaOPT, RN, TF1, TF2, Gt, Ga, Gp, Gmag, Gmsg, GammaMS, GammaML, K, Delta, Mu, MuPrime	Freq
AM/AM, AM/PM	AM

`xformat` is the format to use for the specified `xparameter`. No `xformat` specification is needed when `xparameter` is an operating condition.

The following table shows the `xformat` values that are available for the `xparameter` values listed in the preceding table, along with the default settings that are used if `xformat` is not specified.

xparameter values	xformat values
Pin	dBm (default), mW, W, dBW
Freq	THz, GHz, MHz, KHz, Hz By default, <code>xformat</code> is chosen to provide the best scaling for the given <code>xparameter</code> values.
AM	Magnitude (decibels) (default), Magnitude (linear)

`condition1,value1, . . . , conditionm,valuem` are the optional condition/value pairs at which to plot the specified parameters. These pairs are usually operating conditions from a `.p2d` or `.s2d` file. For some parameters, you can specify a set of frequency or input power values at which to plot the specified parameter.

For example:

- When plotting large-signal S-parameters as a function of input power, you can specify frequency points of interest using condition/value pairs.
- When plotting large-signal S-parameters as a function of frequency, you can specify input power levels of interest using condition/value pairs.
- When plotting parameters as a function of an operating condition, you can specify both frequency and input power values using condition/value pairs.

`freq` is the optional frequency value, in hertz, at which to plot the specified parameters.

`pin` is the optional input power value, in dBm, at which to plot the specified parameters.

If `h` has multiple operating conditions, such as from a `.p2d` or `.s2d` file, the `semilogx` method operates as follows:

- If you do not specify any operating conditions as arguments to the `semilogx` method, then the method plots the parameter values based on the currently selected operating condition.
- If you specify one or more operating conditions, the `semilogx` method plots the parameter values based on those operating conditions.

- When you use an operating condition for the `xparameter` input argument, the method plots the parameters for all operating condition values.

See Also

`analyze` | `calculate` | `extract` | `getz0` | `listformat` | `listparam` | `loglog` | `plot` | `plotyy` | `polar` | `read` | `restore` | `semilogy` | `smith` | `write`

semilogy

Plot specified circuit object parameters using log scale for x -axis

Syntax

```
lineseries = semilogy(h,parameter)
lineseries = semilogy(h,parameter1,...,parametern)
lineseries = semilogy(h,parameter1,...,parametern,format)
lineseries = semilogy(h,'parameter1',...,'parametern',
format,xparameter,xformat,'condition1',value1,...,
'conditionm',valuem, 'freq',freq,'pin',pin)
```

Description

`lineseries = semilogy(h,parameter)` plots the specified `parameter` in the default format using a logarithmic scale for the y -axis. `h` is the handle of a circuit (`rfckt`) object.

Type `listparam(h)` to get a list of valid parameters for a circuit object, `h`. Type `listformat(h,parameter)` to see the legitimate formats for a specified `parameter`. The first listed format is the default for the specified `parameter`.

The `semilogy` method returns a column vector of handles to `lineseries` objects, one handle per line. This output is the same as the output returned by the MATLAB `semilogy` function.

`lineseries = semilogy(h,parameter1,...,parametern)` plots the parameters `parameter1, ..., parametern` from the object `h` on an X-Y plane using a logarithmic scale for the y -axis.

`lineseries = semilogy(h,parameter1,...,parametern,format)` plots the parameters `parameter1, ..., parametern` in the specified format. `format` is the format of the data to be plotted, e.g. 'Magnitude (decibels)'.

Note: For all circuit objects except those that contain data from a data file, you must perform a frequency domain analysis with the `analyze` method before calling `semilogy`.

Use the Property Editor (`propertyeditor`) or the MATLAB `set` function to change Chart Line Properties. The reference pages for MATLAB functions such as `figure`, `axes`, and `text` also list available properties and provide links to more complete property descriptions.

Note: Use the MATLAB `semilogy` function to create a semi-log scale plot of parameters that are specified as vector data and are not part of a circuit (`rfckt`) object or data (`rfddata`) object.

`lineseries = semilogy(h,'parameter1',...,'parameterN',
format,xparameter,xformat,'condition1',value1,...,
'conditionM',valueM, 'freq',freq,'pin',pin)` plots the specified parameters at the specified operating conditions for the object `h`.

`xparameter` is the independent variable to use in plotting the specified parameters. Several `xparameter` values are available for all objects. When you import `rfckt.amplifier`, `rfckt.mixer`, or `rfddata.data` object specifications from a `.p2d` or `.s2d` file, you can also specify any operating conditions from the file that have numeric values, such as `bias`.

The following table shows the most commonly available parameters and the corresponding `xparameter` values. The default settings listed in the table are used if `xparameter` is not specified.

Parameter Name	xparameter values
Pout, Phase, LS11, LS12, LS21, LS22	Pin (default), Freq
S11, S12, S21, S22, NF, IIP3, OIP3, GroupDelay, VSWRIn, VSWROut, GammaIn, GammaOut, FMIN, GammaOPT, RN, TF1, TF2, Gt, Ga, Gp, Gmag, Gmsg, GammaMS, GammaML, K, Delta, Mu, MuPrime	Freq
AM/AM, AM/PM	AM

`xformat` is the format to use for the specified `xparameter`. No `xformat` specification is needed when `xparameter` is an operating condition.

The following table shows the `xformat` values that are available for the `xparameter` values listed in the preceding table, along with the default settings that are used if `xformat` is not specified.

xparameter values	xformat values
Pin	dBm (default), mW, W, dBW
Freq	THz, GHz, MHz, KHz, Hz By default, <code>xformat</code> is chosen to provide the best scaling for the given <code>xparameter</code> values.
AM	Magnitude (decibels) (default), Magnitude (linear)

`condition1,value1, . . . , conditionm,valuem` are the optional condition/value pairs at which to plot the specified parameters. These pairs are usually operating conditions from a `.p2d` or `.s2d` file. For some parameters, you can specify a set of frequency or input power values at which to plot the specified parameter.

For example:

- When plotting large-signal S-parameters as a function of input power, you can specify frequency points of interest using condition/value pairs.
- When plotting large-signal S-parameters as a function of frequency, you can specify input power levels of interest using condition/value pairs.
- When plotting parameters as a function of an operating condition, you can specify both frequency and input power values using condition/value pairs.

`freq` is the optional frequency value, in hertz, at which to plot the specified parameters.

`pin` is the optional input power value, in dBm, at which to plot the specified parameters.

If `h` has multiple operating conditions, such as from a `.p2d` or `.s2d` file, the `semilogy` method operates as follows:

- If you do not specify any operating conditions as arguments to the `semilogy` method, then the method plots the parameter values based on the currently selected operating condition.
- If you specify one or more operating conditions, the `semilogy` method plots the parameter values based on those operating conditions.

- When you use an operating condition for the `xparameter` input argument, the method plots the parameters for all operating condition values.

See Also

`analyze` | `calculate` | `extract` | `getz0` | `listformat` | `listparam` | `loglog` | `plot` | `plotyy` | `polar` | `read` | `restore` | `semilogx` | `smith` | `write`

setup

Set operating conditions

Syntax

```
setup(h)
setup(h, 'Condition1')
setup(h, 'Condition1', value1, 'Condition2', value2, ...)
```

Description

`setup(h)` lists the available values for all operating conditions of the object `h`. Operating conditions only apply to objects you import from a `.p2d` or `.s2d` file. To import these types of data into an object, use the `read` method. Operating conditions are not listed with other properties of an object.

`setup(h, 'Condition1')` lists the available values for the specified operating condition `'Condition1'`.

`setup(h, 'Condition1', value1, 'Condition2', value2, ...)` changes the operating conditions of the circuit or data object, `h`, to those specified by the condition/value pairs. Conditions you do not specify retain their original values. The method ignores any conditions that are not applicable to the specified object. Ignoring these conditions lets you apply the same set of operating conditions to an entire network where different conditions exist for different components.

When you set the operating conditions for a network that contains several objects, the software does not issue an error or warning if the specified conditions cannot be applied to all objects. For some networks, this lack of error or warning lets you call the `setup` method once to apply the same set of operating conditions to any objects where operating conditions are applicable. However, you may want to specify a network that contains one or more of the following:

- Several objects with different sets of operating conditions.
- Several objects with the same set of operating conditions that are configured differently.

To specify operating conditions one of these types of networks, use a separate call to the `setop` method for each object.

Examples

List the possible operating conditions of an object:

```
ckt1 = read(rfckt.amplifier, 'default.p2d');  
setop(ckt1)
```

Analyze an object under specific operating conditions:

```
ckt1 = read(rfckt.amplifier, 'default.p2d');  
freq = ckt1.AnalyzedResult.Freq;  
setop(ckt1, 'Bias', '1.5');  
result1 = analyze(ckt1, freq)
```

See Also

`getop`

show

Produce spur graph for multiband transmitter or receiver

Syntax

```
show(hif)
```

Description

`show(hif)` produces a spur graph of the `OpenIF` object `hif`. The spur graph contains:

- Vertical green bands, representing spur-free zones.
- Horizontal colored bands, representing spurious regions.

The following figure shows a spur graph for the three-mixer multiband receiver example on the `OpenIF` class reference page.

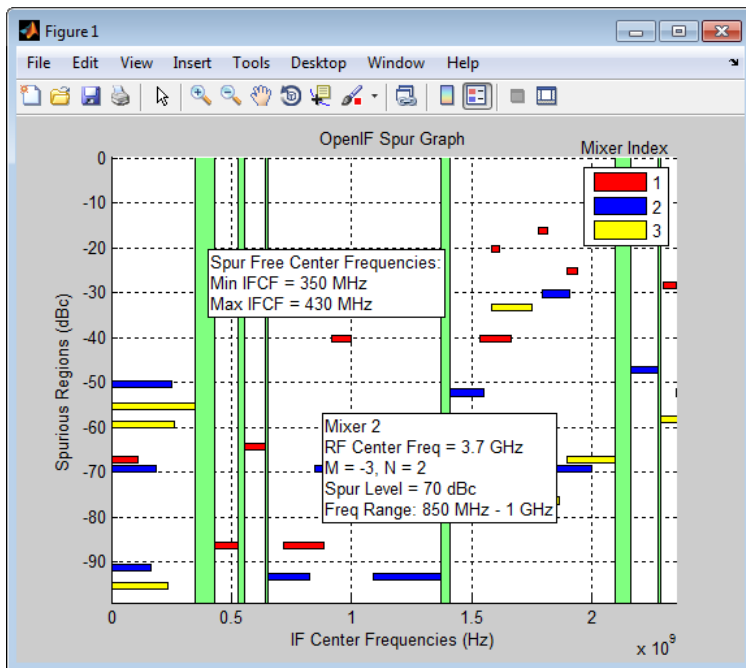

Spur-free zones are ranges of possible IF center frequencies that are free from intermodulation distortion. Depending on the configuration of the mixers in `hif`, spur-free zones may not appear. Clicking on a spur-free zone produces a tooltip, which displays information about the spur-free zone:

- **Min IFCF** — The minimum possible IF center frequency f_{IF} for the corresponding spur-free zone.
- **Max IFCF** — The maximum possible IF center frequency f_{IF} for the corresponding spur-free zone.

Spurious regions contain intermodulation products from at least one mixer. The color of a spur on the spur graph indicates which mixer generates the spur, according to the legend on the spur graph. Clicking on a spurious region produces a tooltip, which displays information about the spur:

- **RF Center Freq** — The RF center frequency f_{RF} of the mixer that generates the spur
- **M, N** — The coefficients in the equation $|Mf_{RF} - N(f_{RF} \pm f_{IF})|$ (down-conversion) or the equation $|Mf_{IF} + N(f_{RF} \pm f_{IF})|$. The sign of ‘ \pm ’ in these equations is determined by the

injection type of the mixer. These coefficients refer to the particular mixing product that generates the spurious region.

- **Spur Level** — The difference in magnitude between a signal at 0 dBc and the spur. If you set `hif.SpurLevel` to a number greater than this value, then `hif` does not report the region as spurious.
- **Freq Range** — The frequency range of the spurious region. Choosing an IF center frequency in this range causes interference with the intermodulation product corresponding to the spur.

Input Arguments

`hif` — IF planning object

OpenIF object

Intermediate frequency planning (IF) object, specified as an OpenIF object.

Alternatives

- The `getSpurFreeZoneData` function returns the endpoints of the spur-free zones in a matrix.
- The `report` method displays mixer configurations, intermodulation tables, and spur-free zone information at the command line.

Examples

- The OpenIF class reference page contains an example that shows how to find the spur-free zones of a multiband receiver with three mixers.
- The example Finding Free IF Bandwidths shows how to use information from a spur graph to design a multiband receiver with spur-free zones.

See Also

`addMixer` | `getSpurData` | `getSpurFreeZoneData` | `report` | `OpenIF`

smith

Plot specified circuit object parameters on Smith chart

Syntax

```
smith(hnet,i,j)
hsm = smith(hnet,i,j)
[lineseries,hsm] = smith(h,parameter1,...,parametern,type)
[lineseries,hsm] = smith(h,'parameter1',...,'parametern',
type,xparameter,xformat,'condition1',value1,...,
'conditionm',valuem, 'freq',freq,'pin',pin)
```

Description

`smith(hnet,i,j)` plots the (i,j) th parameter of `hnet` on a Smith Chart. `hnet` is an RF Toolbox network parameter object. The inputs `i` and `j` are positive integers whose value is less than or equal to 2 for hybrid and hybrid-g parameter objects, or less than or equal to `hnet.NumPorts` for ABCD, S, Y, or Z-parameter objects.

`hsm = smith(hnet,i,j)` returns the lineseries handle used to create the plot, `hsm`.

`[lineseries,hsm] = smith(h,parameter1,...,parametern,type)` plots the network parameters `parameter1, ..., parametern` from the object `h` on a Smith chart. `h` is the handle of a circuit (`rfckt`) or data (`rfdata`) object that contains n -port network parameter data. `type` is a string that specifies the type of Smith chart:

- 'z' (default)
- 'y'
- 'zy'

Type `listparam(h)` to get a list of valid parameters for a circuit object `h`.

Note: For all circuit objects except those that contain data from a data file, you must use the `analyze` method to perform a frequency domain analysis before calling `smith`.

`[lineseries,hsm] = smith(h,'parameter1',...,'parameterN', type,xparameter,xformat,'condition1',value1,..., 'conditionm',valuem, 'freq',freq,'pin',pin)` plots the specified parameters at the specified operating conditions for the object `h`.

`xparameter` is the independent variable to use in plotting the specified parameters. Several `xparameter` values are available for all objects. When you import 2-port `rfckt.amplifier`, `rfckt.mixer`, or `rfdata.data` object specifications from a `.p2d` or `.s2d` file, you can also specify any operating conditions from the file that have numeric values, such as `bias`.

The following table shows the most commonly available parameters and the corresponding `xparameter` values. The default settings listed in the table are used if `xparameter` is not specified.

Parameter Name	xparameter values
Pout, Phase, LS11, LS12, LS21, LS22	Pin (default), Freq
S11, S12, S21, S22, NF, IIP3, OIP3, VSWRIn, VSWRout, GammaIn, GammaOut, FMIN, GammaOPT, RN	Freq
AM/AM, AM/PM	AM

`xformat` is the format to use for the specified `xparameter`. No `xformat` specification is needed when `xparameter` is an operating condition.

The following table shows the `xformat` values that are available for the `xparameter` values listed in the preceding table, along with the default settings that are used if `xformat` is not specified.

xparameter values	xformat values
Pin	dBm (default), mW, W, dBW
Freq	THz, GHz, MHz, KHz, Hz By default, <code>xformat</code> is chosen to provide the best scaling for the given <code>xparameter</code> values.
AM	Magnitude (decibels) (default), Magnitude (linear)

`condition1,value1, ..., conditionm,valuem` are the optional condition/value pairs at which to plot the specified parameters. These pairs are usually operating conditions from a `.p2d` or `.s2d` file. For some parameters, you can specify a set of frequency or input power values at which to plot the specified parameter.

For example:

- When plotting large-signal S-parameters as a function of input power, you can specify frequency points of interest using condition/value pairs.
- When plotting large-signal S-parameters as a function of frequency, you can specify input power levels of interest using condition/value pairs.
- When plotting parameters as a function of an operating condition, you can specify both frequency and input power values using condition/value pairs.

`freq` is the optional frequency value, in hertz, at which to plot the specified parameters.

`pin` is the optional input power value, in dBm, at which to plot the specified parameters.

If `h` has multiple operating conditions, such as from a `.p2d` or `.s2d` file, the `smith` method operates as follows:

- If you do not specify any operating conditions as arguments to the `smith` method, then the method plots the parameter values based on the currently selected operating condition.
- If you specify one or more operating conditions, the `smith` method plots the parameter values based on those operating conditions.
- When you use an operating condition for the `xparameter` input argument, the method plots the parameters for all operating condition values.

Note: Use the `smithchart` function to plot network parameters that are not part of a circuit (`rfckt`) or data (`rfdata`) object, but are specified as vector data.

Changing Properties of the Plotted Lines

The `smith` method returns `lineseries`, a column vector of handles to `lineseries` objects, one handle per plotted line. Use the Chart Line Properties function to change the properties of these lines.

Changing Properties of the Smith Chart

The `smith` method returns the handle `hsm` of the Smith chart. Use the properties listed below to change the properties of the chart itself.

Properties

`smith` creates the plot using the default property values of a Smith chart. Use `set(hsm, 'PropertyName1', PropertyValue1, ...)` to change the property values of the chart. Use `get(hsm)` to get the property values.

This table lists all properties you can specify for a Smith chart object along with units, valid values, and a descriptions of their use.

Property Name	Description	Units, Values
Color	Line color for a Z or Y Smith chart. For a ZY Smith chart, the Z line color.	ColorSpec. Default is [0.4 0.4 0.4] (dark gray).
LabelColor	Color of the line labels.	ColorSpec. Default is [0 0 0] (black).
LabelSize	Size of the line labels.	FontSize. Default is 10. See the Annotation Text Box Properties reference page for more information on specifying font size.
LabelVisible	Visibility of the line labels.	'on' (default) or 'off'
LineType	Line spec for a Z or Y Smith chart. For a ZY Smith chart, the Z line spec.	LineStyle. Default is '-' (solid line).
LineWidth	Line width for a Z or Y Smith chart. For a ZY Smith chart, the Z line width.	Number of points. Default is 0.5.
SubColor	The Y line color for a ZY Smith chart.	ColorSpec. Default is [0.8 0.8 0.8] (medium gray).

Property Name	Description	Units, Values
SubLineType	The Y line spec for a ZY Smith chart.	LineSpec. Default is ':' (dotted line).
SubLineWidth	The Y line width for a ZY Smith chart.	Number of points. Default is 0.5.
Type	Type of Smith chart.	'z' (default), 'y', or 'zy'
Value	Two-row matrix. Row 1 specifies the values of the constant resistance and reactance lines that appear on the chart. For the constant resistance/reactance lines, each element in Row 2 specifies the value of the constant reactance/resistance line at which the corresponding line specified in Row 1 ends.	2-by-n matrix. Default is [0.2000 0.5000 1.0000 2.0000 5.0000; 1.0000 2.0000 5.0000 5.0000 30.0000]

See Also

analyze | calculate | circle | getz0 | listformat | listparam | loglog | plot | plotyy | polar | read | restore | semilogx | semilogy | write

stepresp

Step-signal response of rational function object

Syntax

```
[yout,tout] = stepresp(h, ts, n, trise)
```

Description

[yout,tout] = stepresp(h, ts, n, trise) calculates the time-domain response of a rational function object, h, to a step signal, defined as:

$$\begin{cases} U(kt_s) = kt_s / t_{rise}, & 0 \leq k < (t_{rise} / t_s) \\ U(kt_s) = 1, & (t_{rise} / t_s) \leq k \leq N \end{cases}$$

The input h is the handle of a rational function object returned by `rationalfit`. The variable t_s is the sample time, `ts`; N is the number of samples, `n`; and t_{rise} is the time, `trise`, that it takes for the step signal to reach its maximum value. The variable k is an integer between 0 and N , referring to the index of the samples.

The following figure illustrates the construction of this signal.

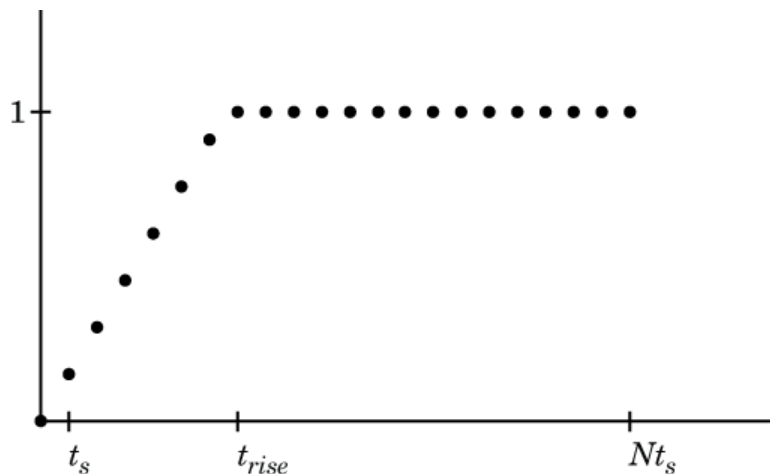

The output `yout` is the response of the step signal at time `tout`.

Examples

Calculate the step response of a rational function object:

```
% Read a .S2P data file
S = sparameters('passive.s2p');
freq = S.Frequencies;
% Get S11 and convert to a TDR transfer function
s11 = rfparam(S,1,1);
Vin = 1;
tdrfreqdata = Vin*(s11+1)/2;
% Fit to a rational function object
tdrfit = rationalfit(freq,tdrfreqdata);
% Define parameters for a step signal
Ts = 1.0e-11;
N = 10000;
Trise = 1.0e-10;
% Calculate the step response for TDR and plot it
[tdr,t1] = stepresp(tdrfit,Ts,N,Trise);
figure
plot(t1*1e9,tdr)
ylabel('TDR')
xlabel('Time (ns)')
```

More About

- `rfmodel.rational`

See Also

`freqresp` | `rationalfit` | `timeresp`

table

Display specified RF object parameters in Variable Editor

Syntax

```
table(h,param1,format1,..., paramn,formatn)  
table(h,'budget',param1,format1,...,paramn,formatn)
```

Description

`table(h,param1,format1,..., paramn,formatn)` displays the specified parameters *param1* through *paramn*, with units *format1* through *formatn*, in the Variable Editor. The input *h* is a function handle to an `rfckt` object.

The method creates a structure in the MATLAB workspace and constructs the name of the structure from the names of the object and parameters you provide. Specify parameters and formats in pairs. If you do not specify a format, the method uses the default format for that parameter.

To list valid parameters and parameter formats for *h*, use the `listparam` and `listformat` methods.

`table(h,'budget',param1,format1,...,paramn,formatn)` specified budget parameters of an `rfckt.cascade` object *h*.

Examples

Analyze an RF cascade and display the link budget in a table:

```
% Construct a cascaded RFCKT object  
Cascaded_Ckt = rfckt.cascade('Ckts', ...  
    {rfckt.txline('LineLength', .001), ...  
    rfckt.amplifier, rfckt.txline( ...  
    'LineLength', 0.025, 'PV', 2.0e8)})  
% Do frequency domain analysis at the given frequency  
freq = 2.1e9;
```

```
analyze(Cascaded_Ckt,freq);  
% Plot the Budget S21 and NF  
plot(Cascaded_Ckt, 'budget', 'S21', 'NF');  
% Display the Budget S21 and NF in a table  
table(Cascaded_Ckt, 'budget', 'S21', 'NF');
```

See Also

openvar | plot

timeresp

Time response for rational function object

Syntax

```
[y,t] = timeresp(h,u,ts)
```

Description

`[y,t] = timeresp(h,u,ts)` computes the output signal, `y`, that the rational function object, `h`, produces in response to the given input signal, `u`.

The input `h` is the handle of a rational function object returned by `rationalfit`. `ts` is a positive scalar value that specifies the sample time of the input signal.

The output `y` is the output signal. RF Toolbox software computes the value of the signal at the time samples in the vector `t` using the following equation.

$$Y(n) = \text{sum}(C .* X(n - \text{Delay} / ts)) + D * U(n - \text{Delay} / ts)$$

where

$$X(n + 1) = F * X(n) + G * U(n)$$

$$X(1) = 0$$

$$F = \exp(A * ts)$$

$$G = (F - 1) ./ A$$

and `A`, `C`, `D`, and `Delay` are properties of the rational function object, `h`.

Examples

The following example shows you how to compute the time response of the data stored in the file `default.s2p` by fitting a rational function object to the data and using the `timeresp` method to compute the time response of the object.

```
% Define the input signal
SampleTime = 2e-11;
OverSamplingFactor = 25;
TotalSampleNumber = 2^12;
InputTime = double((1:TotalSampleNumber)')*SampleTime;
InputSignal = sign(randn(1, ...
    ceil(TotalSampleNumber/OverSamplingFactor)));
InputSignal = repmat(InputSignal, [OverSamplingFactor, 1]);
InputSignal = InputSignal(:);

% Create a rational function object
orig_data=read(rfdata.data,'default.s2p');
freq=orig_data.Freq;
data=orig_data.S_Parameters(2,1,:);
fit_data=rationalfit(freq,data);

% Compute the time response
[y,t]=timeresp(fit_data,InputSignal,SampleTime);
```

More About

- `rfmodel.rational`

See Also

`freqresp` | `rationalfit` | `writeva`

write

Write RF data from circuit or data object to file

Syntax

```
status = write(data, filename, dataformat, funit, printformat,
              freqformat)
```

Description

`status = write(data, filename, dataformat, funit, printformat, freqformat)` writes information from `data` to the specified file. `data` is a circuit object or `rfdata.data` object that contains sufficient information to write the specified file. `filename` is a string representing the filename of a `.snp`, `.ynp`, `.znp`, `.hnp`, or `.amp` file, where `n` is the number of ports. The default `filename` extension is `.snp`. `write` returns `True` if the operation is successful and returns `False` otherwise.

`dataformat` specifies the format of the data to be written. It must be one of the case-insensitive strings in the following table.

Format	Description
'DB'	Data is given in (dB-magnitude, angle) pairs with angle in degrees.
'MA'	Data is given in (magnitude, angle) pairs with angle in degrees.
'RI'	Data is given in (real, imaginary) pairs (default).

`funit` specifies the frequency units of the data to be written. It must be `'GHz'`, `'MHz'`, `'KHz'`, or `'Hz'`. If you do not specify `funit`, its value is taken from the object `data`. All values are case-insensitive.

The `printformat` string that specifies the precision of the network and noise parameters. The default value is `%22.10f`. This value means the method writes the data using fixed-point notation with a precision of 10 digits. The minimum positive value the `write` method can express by default is `1e-10`. For greater precision, specify a different `printformat`. See the Format String specification for `fprintf`.

The `freqformat` string that specifies the precision of the frequency. The default value is `%-22.10f`. See the Format String specification for `fprintf`.

Note: The method only writes property values from `data` that the specified output file supports. For example, Touchstone files, which have the `.snp`, `.ynp`, `.znp`, or `.hnp` extension, do not support noise figure or output third-order intercept point. Consequently, the `write` method does not write these property values to these such files.

Examples

The following example shows you how to analyze the data stored in the file `default.s2p` for a different set of frequency values, and use the `write` method to store the results in a file called `test.s2p`.

```
orig_data=read(rfdata.data, 'default.s2p')
freq=[1:.1:2]*1e9;
analyze(orig_data, freq);
write(orig_data, 'test.s2p');
```

References

EIA/IBIS Open Forum, “Touchstone File Format Specification,” Rev. 1.1, 2002 (http://www.vhdl.org/pub/ibis/connector/touchstone_spec11.pdf).

See Also

`analyze` | `calculate` | `extract` | `getz0` | `listformat` | `listparam` | `loglog` | `plot` | `plotyy` | `polar` | `semilogx` | `semilogy` | `smith` | `read` | `restore`

writeva

Write Verilog-A description of rational function object

Syntax

```
status = writeva(h, filename, innets, outnets, ...  
                printfmt, discipline, filestoinclude)
```

Description

`status = writeva(h, filename, innets, outnets, printfmt, discipline, filestoinclude)` writes a Verilog-A module that describes a rational function object `h` to the file specified by `filename`. The method implements the object in Verilog-A using Laplace Transform S-domain filters. It returns a `status` of `True`, if the operation is successful, and `False` if it is unsuccessful.

`h` is the handle to the rational function object. Typically, the `rationalfit` function creates this object when you fit a rational function to a set of data.

`filename` is a string representing the name of the Verilog-A file to which to write the module. The `filename` can be specified with or without a path name and extension. The default extension, `.va`, is added automatically if `filename` does not end in this extension. The module name that is used in the file is the part of the `filename` that remains when the path name and extension are removed.

`innets` is a string or a cell of two strings that specifies the name of each of the module's input nets. The default is `'in'`.

`outnets` is a string or a cell of two strings that specifies the name of each of the module's output nets. The default is `'out'`.

`printfmt` is a string that specifies the precision of the following Verilog-A module parameters using the C language conversion specifications:

- The numerator and denominator coefficients of the Verilog-A filter.
- The module's delay value and constant offset (or direct feedthrough), which are taken directly from the rational function object.

The default is `'%15.10e'`. For more information on how to specify `printf` format, see the Format String specification for `fprintf`.

`discipline` is a string that specifies the predefined Verilog-A discipline of the nets. The discipline defines attributes and characteristics associated with the nets. The default is `'electrical'`.

`filestoinclude` is a cell of strings that specifies a list of header files to include in the module using Verilog-A `'`include'` statements. By default, `filestoinclude` is set to `'`include discipline.vams'`.

For more information on Verilog-A, see the Verilog-A Reference Manual.

More About

- `rfmodel.rational`

See Also

`freqresp` | `rationalfit` | `timeresp`

newref

Change reference impedance of S-parameters

Syntax

```
hs2 = newref (hs,Z0)
```

Description

`hs2 = newref (hs,Z0)` creates an S-parameter object, `hs2`, by converting the S-parameters in `hs` to the specified reference impedance, `Z0`.

Examples

Change reference impedance of S-parameters

Create an S-parameters object from data in the file, `default.s2p`.

```
hs = sparameters('default.s2p');
```

Change the reference impedance to 40 ohms.

```
hs2 = newref (hs,40);
```

Input Arguments

hs — S-parameters

network parameter object

S-parameters, specified as an RF Toolbox network parameter object. To create this type of object, use the `sparameters` function.

Z0 — Reference impedance

real positive scalar

Characteristic impedance, in ohms, specified as a real positive scalar.

Output Arguments

hs2 — S-parameters

network parameter object

S-parameters with reference impedance Z_0 , returned as an RF Toolbox network parameter object.

See Also

sparameters

rfinterp1

Interpolate network parameter data

Syntax

```
hnet2 = rfinterp1(hnet, freq)
```

Description

`hnet2 = rfinterp1(hnet, freq)` interpolates the network parameter data in `hnet` at the specified frequencies, `freq`, storing the results in `hnet2`.

Examples

Interpolate S-parameter data

Read the data from the file `default.s2p` into an S-parameter object.

```
hnet = sparameters('default.s2p');
```

Interpolate the data at a specified set of frequencies.

```
freq = [1.2:0.2:2.8]*1e9;  
hnet2 = rfinterp1(hnet, freq);
```

Input Arguments

hnet — Original data

network parameter object

Data to interpolate, specified as an RF Toolbox network parameter object.

freq — Frequencies

vector of positive numbers

Frequencies of interpolation, specified as a vector of positive numbers ordered from smallest to largest.

Output Arguments

hnet2 — Interpolated data

network parameter object

Result of interpolation, returned as an RF Toolbox network parameter object of the same type as `hnet`.

More About

Algorithms

The function uses the MATLAB function `interp1` to perform the interpolation operation. Overall performance is similar to the RF Toolbox `analyze` function. However, behaviors of the two functions differ when `freq` contains frequencies outside the range of the original data:

- `analyze` performs a zeroth-order extrapolation for out-of-range data points.
- `rfinterp1` inserts NaN values for out-of-range data points.

See Also

`analyze` | `interp1`

rfparam

Extract vector of network parameters

Syntax

```
n_ij = rfparam(hnet,i,j)
abcd_vector = rfparam(habcd,abcdflag)
```

Description

`n_ij = rfparam(hnet,i,j)` extracts the network parameter vector (i,j) from the network parameter object, `hnet`.

`abcd_vector = rfparam(habcd,abcdflag)` extracts the A , B , C , or D vector from ABCD-parameter object, `habcd`.

Examples

Create Data Vector From S-Parameter Object

Read in the file `default.s2p` into an `sparameters` object and get the S_{21} value.

```
S = sparameters('default.s2p');
s21 = rfparam(S,2,1)
```

```
s21 =
-0.6857 + 1.7827i
-0.6560 + 1.7980i
-0.6262 + 1.8131i
-0.5963 + 1.8278i
-0.5664 + 1.8422i
-0.5363 + 1.8563i
-0.5062 + 1.8700i
-0.4760 + 1.8835i
-0.4457 + 1.8966i
-0.4152 + 1.9094i
-0.3847 + 1.9219i
```

-0.3542 + 1.9339i
-0.3236 + 1.9455i
-0.2930 + 1.9566i
-0.2623 + 1.9674i
-0.2316 + 1.9779i
-0.2008 + 1.9882i
-0.1698 + 1.9983i
-0.1387 + 2.0084i
-0.1073 + 2.0185i
-0.0758 + 2.0286i
-0.0441 + 2.0387i
-0.0124 + 2.0488i
0.0194 + 2.0588i
0.0513 + 2.0687i
0.0834 + 2.0785i
0.1158 + 2.0882i
0.1484 + 2.0977i
0.1813 + 2.1072i
0.2145 + 2.1164i
0.2482 + 2.1256i
0.2821 + 2.1344i
0.3161 + 2.1430i
0.3504 + 2.1513i
0.3849 + 2.1595i
0.4197 + 2.1676i
0.4550 + 2.1757i
0.4908 + 2.1839i
0.5272 + 2.1922i
0.5642 + 2.2007i
0.6020 + 2.2095i
0.6403 + 2.2186i
0.6792 + 2.2281i
0.7186 + 2.2377i
0.7587 + 2.2476i
0.7994 + 2.2575i
0.8410 + 2.2675i
0.8833 + 2.2774i
0.9266 + 2.2871i
0.9708 + 2.2967i
1.0161 + 2.3061i
1.0623 + 2.3152i
1.1091 + 2.3243i
1.1567 + 2.3333i
1.2053 + 2.3423i

1.2551 + 2.3512i
1.3062 + 2.3600i
1.3588 + 2.3687i
1.4131 + 2.3774i
1.4691 + 2.3860i
1.5272 + 2.3944i
1.5870 + 2.4032i
1.6484 + 2.4123i
1.7115 + 2.4218i
1.7768 + 2.4313i
1.8443 + 2.4407i
1.9143 + 2.4497i
1.9871 + 2.4582i
2.0629 + 2.4659i
2.1419 + 2.4726i
2.2243 + 2.4782i
2.3101 + 2.4840i
2.3991 + 2.4911i
2.4918 + 2.4987i
2.5887 + 2.5060i
2.6900 + 2.5120i
2.7962 + 2.5161i
2.9077 + 2.5174i
3.0248 + 2.5150i
3.1481 + 2.5082i
3.2778 + 2.4961i
3.4155 + 2.4848i
3.5624 + 2.4786i
3.7185 + 2.4736i
3.8836 + 2.4662i
4.0576 + 2.4524i
4.2405 + 2.4287i
4.4322 + 2.3911i
4.6326 + 2.3359i
4.8415 + 2.2595i
5.0590 + 2.1579i
5.3116 + 2.0531i
5.6159 + 1.9604i
5.9571 + 1.8657i
6.3204 + 1.7550i
6.6908 + 1.6143i
7.0535 + 1.4295i
7.3937 + 1.1868i
7.6964 + 0.8720i

7.9468 + 0.4711i
8.1299 - 0.0298i
8.3110 - 0.6357i
8.5403 - 1.3306i
8.7814 - 2.0977i
8.9975 - 2.9196i
9.1519 - 3.7795i
9.2080 - 4.6601i
9.1291 - 5.5445i
8.8786 - 6.4155i
8.4198 - 7.2560i
7.7160 - 8.0490i
6.8506 - 8.6946i
5.9420 - 9.1242i
5.0061 - 9.3672i
4.0588 - 9.4532i
3.1158 - 9.4116i
2.1931 - 9.2719i
1.3066 - 9.0637i
0.4720 - 8.8165i
-0.2947 - 8.5596i
-0.9777 - 8.3228i
-1.5383 - 8.0622i
-1.9620 - 7.7264i
-2.2692 - 7.3328i
-2.4800 - 6.8992i
-2.6148 - 6.4430i
-2.6939 - 5.9818i
-2.7376 - 5.5332i
-2.7663 - 5.1147i
-2.8001 - 4.7441i
-2.8594 - 4.4387i
-2.9211 - 4.1801i
-2.9519 - 3.9375i
-2.9569 - 3.7102i
-2.9413 - 3.4973i
-2.9102 - 3.2982i
-2.8689 - 3.1120i
-2.8225 - 2.9379i
-2.7761 - 2.7753i
-2.7349 - 2.6234i
-2.7041 - 2.4813i
-2.6776 - 2.3487i
-2.6464 - 2.2251i

-2.6116 - 2.1099i
-2.5741 - 2.0022i
-2.5348 - 1.9015i
-2.4946 - 1.8069i
-2.4544 - 1.7178i
-2.4154 - 1.6335i
-2.3782 - 1.5531i
-2.3440 - 1.4761i
-2.3111 - 1.4026i
-2.2778 - 1.3333i
-2.2442 - 1.2679i
-2.2106 - 1.2060i
-2.1771 - 1.1474i
-2.1442 - 1.0918i
-2.1119 - 1.0388i
-2.0805 - 0.9882i
-2.0504 - 0.9396i
-2.0216 - 0.8929i
-1.9938 - 0.8481i
-1.9662 - 0.8054i
-1.9391 - 0.7647i
-1.9124 - 0.7258i
-1.8862 - 0.6887i
-1.8605 - 0.6532i
-1.8353 - 0.6190i
-1.8108 - 0.5861i
-1.7870 - 0.5543i
-1.7640 - 0.5235i
-1.7415 - 0.4938i
-1.7195 - 0.4652i
-1.6978 - 0.4378i
-1.6766 - 0.4114i
-1.6558 - 0.3860i
-1.6353 - 0.3615i
-1.6152 - 0.3377i
-1.5954 - 0.3147i
-1.5759 - 0.2924i
-1.5567 - 0.2706i
-1.5377 - 0.2493i
-1.5189 - 0.2286i
-1.5003 - 0.2086i
-1.4819 - 0.1892i
-1.4638 - 0.1704i
-1.4459 - 0.1523i

```
-1.4283 - 0.1349i  
-1.4110 - 0.1182i  
-1.3940 - 0.1022i  
-1.3773 - 0.0869i
```

Input Arguments

abcdflag — ABCD-parameter index

'A' | 'B' | 'C' | 'D'

Flag that determines which ABCD parameters the function extracts, specified as 'A', 'B', 'C', or 'D'.

habcd — 2-port ABCD parameters

ABCD parameter object

2-port ABCD parameters, specified as an RF Toolbox ABCD parameter object. When you specify **abcdflag**, you must also specify an ABCD parameter object.

hnet — Network parameters

network parameter object

Network parameters, specified as an RF Toolbox network parameter object.

i — Row index

positive integer

Row index of data to extract, specified as a positive integer.

j — Column index

positive integer

Column index of data to extract, specified as a positive integer.

Output Arguments

n_ij — Network parameters (*i*, *j*)

vector

Network parameters (i, j), returned as a vector. The i and j input arguments determine which parameters the function returns.

Example: `S_21 = rfparam(hs,2,1)`

abcd_vector — A, B, C, or D- parameters

vector

A , B , C , or D - parameters, returned as a vector. The `abcdflag` input argument determines which parameters the function returns. The function supports only 2-port ABCD parameters; thus, the output is always a vector.

Example: `a_vector = rfparam(habcd,'A');`

rfplot

Plot S-parameter data

Syntax

```
rfplot(s_obj)
rfplot(s_obj,i,j)
rfplot( ____,lineSpec)
rfplot( ____,plotflag)
hline = rfplot( ____ )
```

Description

`rfplot(s_obj)` plots the magnitude in dB versus frequency of all S-parameters (S_{11} , S_{12} ... S_{NN}) on the current axis. `s_obj` must be an s-parameter object.

`rfplot(s_obj,i,j)` plots the magnitude of $S_{i,j}$, in decibels, versus frequency on the current axis.

`rfplot(____,lineSpec)` plots S-parameters using optional line types, symbols, and colors specified by `linespec`.

`rfplot(____,plotflag)` allows to specify the type of plot by using the `plotflag`.

`hline = rfplot(____)` plots the S-parameters and returns the column vector of handles to the line objects, `hline`.

Examples

Plot S-Parameter Data Using rfplot

Create S-parameter

```
hs = sparameters('default.s2p');
```

Plot all S-paramteres

```
figure;  
rfplot(hs)
```

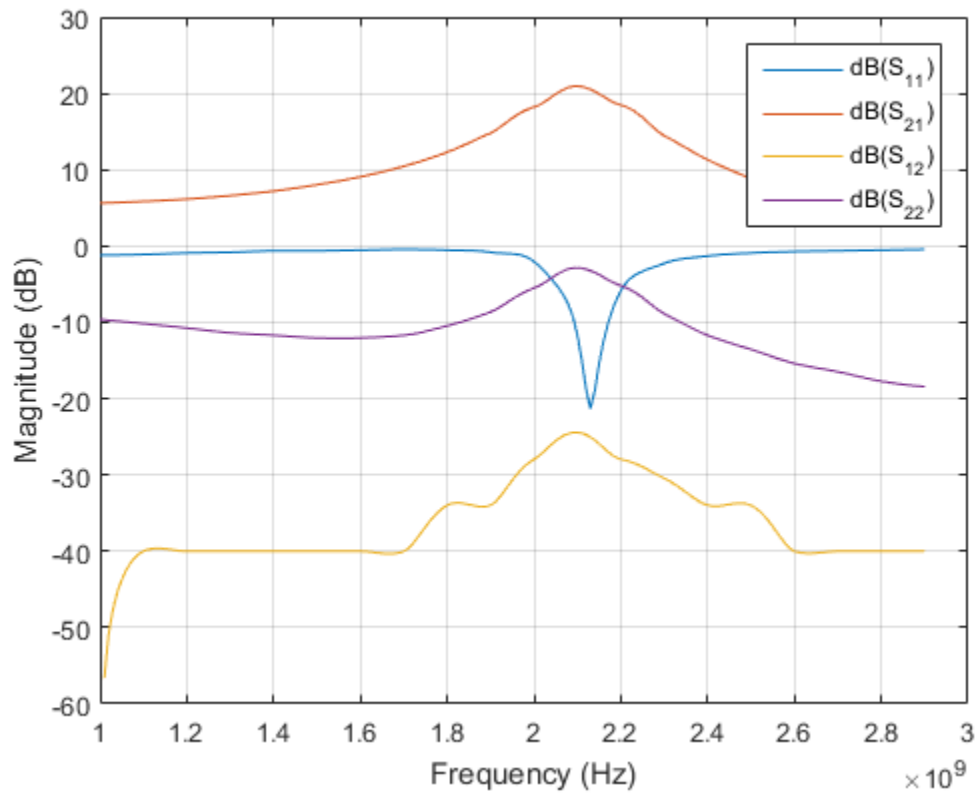
**Plot S21**

```
figure;  
rfplot(hs,2,1)
```

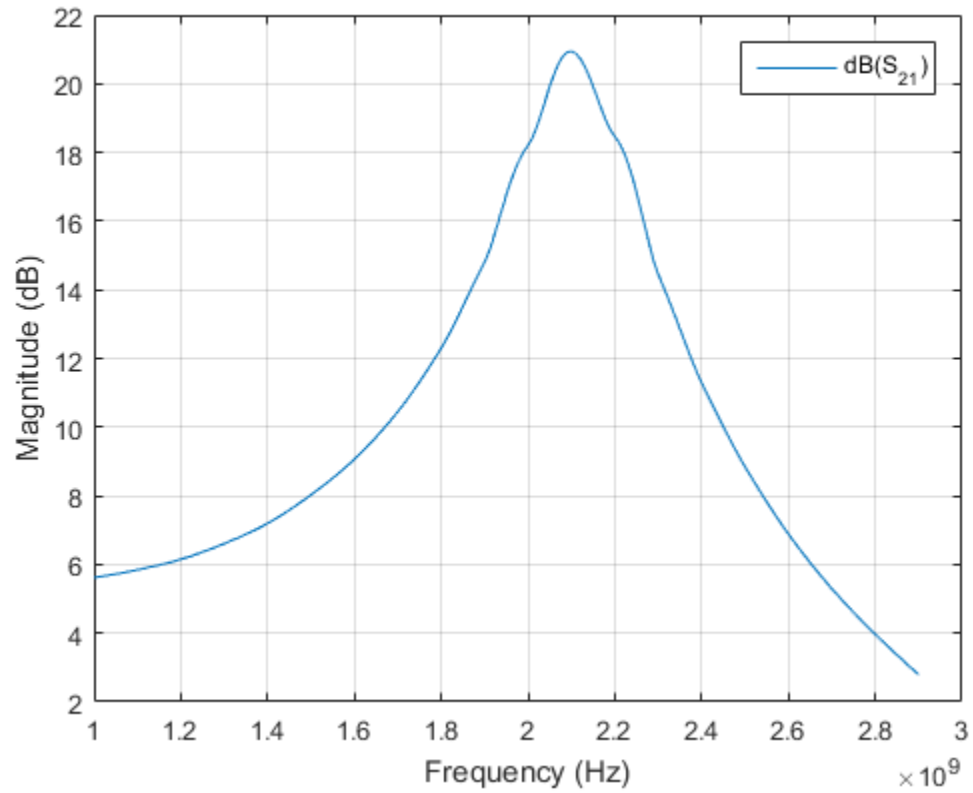

Plot the angle of S21 in degrees

```
rfplot(hs,2,1,'angle')
```

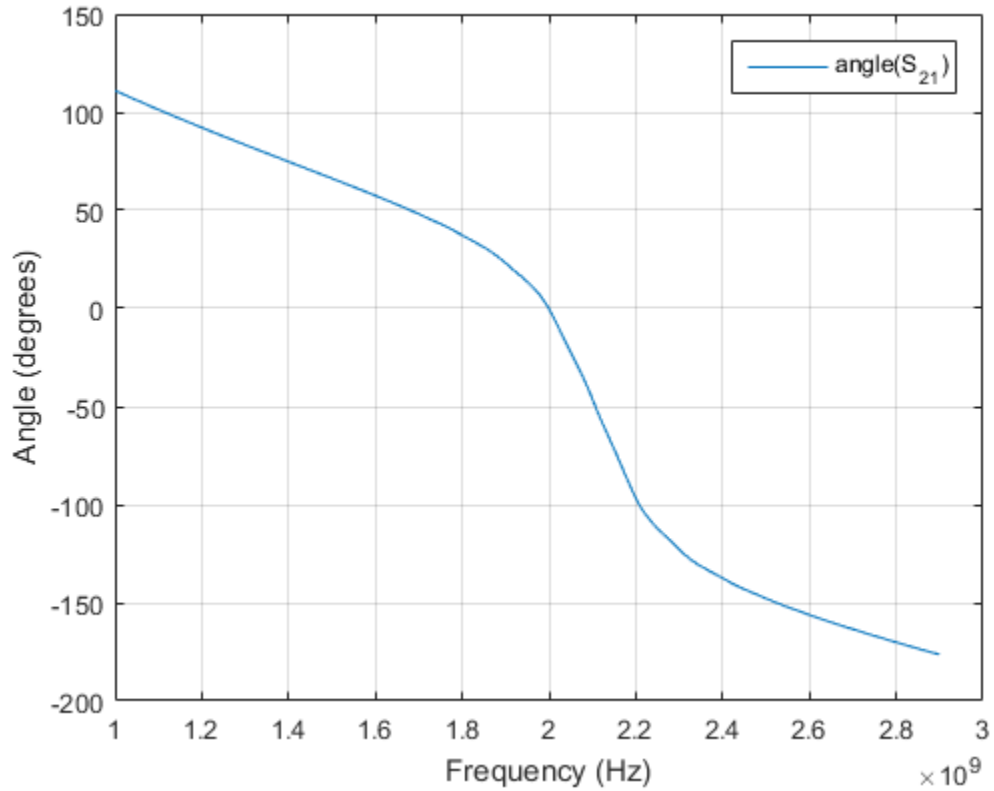

Plot the real part of S21

```
rfplot(hs,2,1,'real')
```

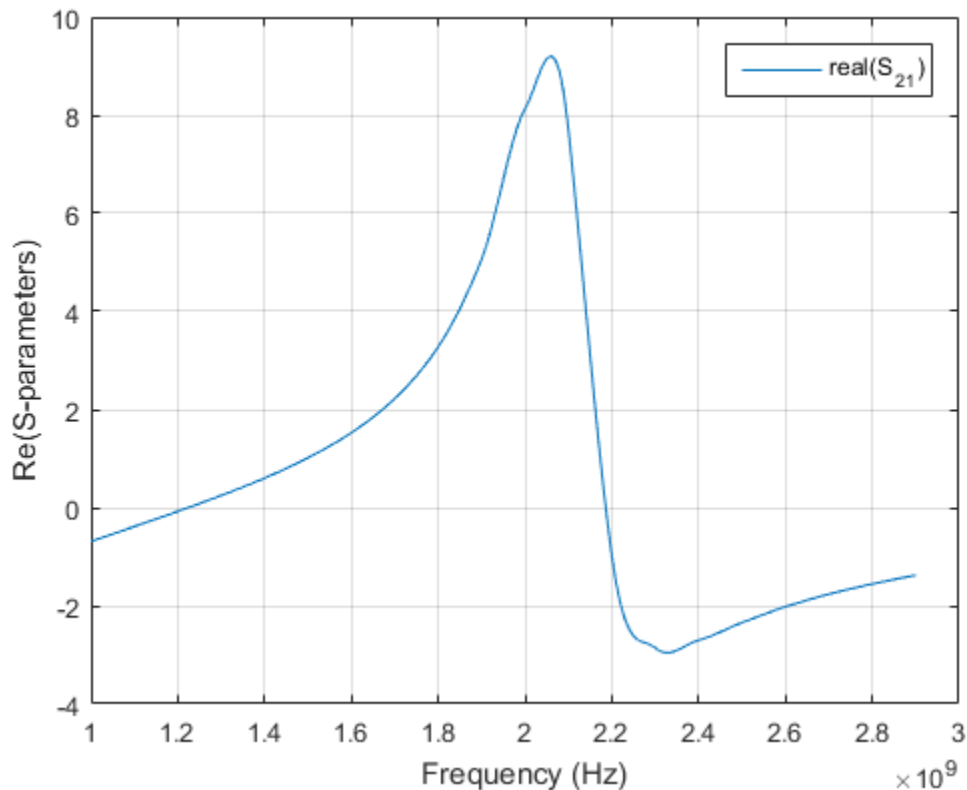
Input Arguments

s_obj — S-parameters

network parameter object

S-parameters, specified as an RF Toolbox network parameter object. To create this type of object, use the `sparameters` function.

i — Row index

positive integer

Row index of data to plot, specified as a positive integer.

j — Column index

positive integer

Column index of data to plot, specified as a positive integer.

lineSpec — Line specification

character string

Line specification, specified as a character string, that modifies the line types, symbols, and colors of the plot. The function takes string specifiers in the same format as `plot` command. For more information on line specification strings, see `linespec`.

Example: `'-or'`

plotflag — Plot types

`'db'` (default) | character string

Plot types, specified as a character string. The valid plot flags are `'db'`, `'real'`, `'imag'`, `'abs'`, `'angle'`.

Example: `'angle'`

Output Arguments

hline — Line

line handle

Line containing the S-parameter plot, returned as a line handle.

See Also

`rfinterp1` | `rfparam` | `smith`

sparameters

Create S-parameter object

Syntax

```
obj = sparameters(filename)
```

```
obj = sparameters(data,freq)
```

```
obj = sparameters(cktobj,freq,Z0)
```

```
obj = sparameters(obj)
```

```
obj = sparameters(__,Z0)
```

```
obj = sparameters(rftbobj)
```

Description

`obj = sparameters(filename)` creates an S-parameter object `obj` by importing data from the Touchstone file specified by `filename`.

`obj = sparameters(data,freq)` creates an S-parameter object from the S-parameter data, `data`, and frequencies, `freq`.

`obj = sparameters(cktobj,freq,Z0)` calculates the S-parameters of a circuit object.

`obj = sparameters(obj)` copies the contents of s-parameter object, `hs`.

`obj = sparameters(__,Z0)` creates an S-parameter object with a new impedance of `Z0`.

`obj = sparameters(rftbobj)` extracts network data from `rftbobj` and converts it into S-parameter data.

Examples

Extract and Plot the S-parameters of File

Extract S-parameters from file `default.s2p` and plot it.

```
S = sparameters('default.s2p');  
disp(S)  
rfplot(S)
```

```
sparameters: S-parameters object
```

```
    NumPorts: 2  
Frequencies: [191x1 double]  
Parameters: [2x2x191 double]  
Impedance: 50
```

```
rfparam(obj,i,j) returns S-parameter Sij
```

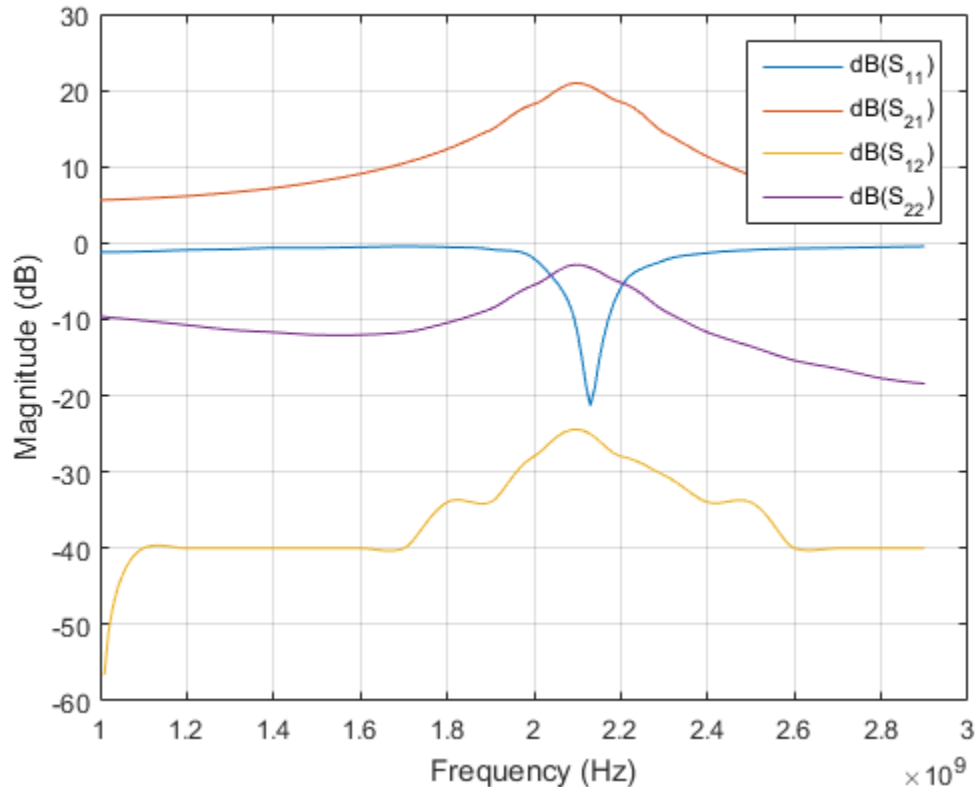

Calculate the S-parameters of Circuit Object

Create a resistor element R50 and add it to a circuit object `example2`. Calculate the S-parameters of `example2`.

```
hR1 = resistor(50, 'R50');
hckt1 = circuit('example2');
add(hckt1, [1 2], hR1)
setports(hckt1, [1 0], [2 0])
freq = linspace(1e3, 2e3, 100);
S = sparameters(hckt1, freq, 100);
disp(S)
```

```
sparameters: S-parameters object
```

```
    NumPorts: 2
    Frequencies: [100x1 double]
    Parameters: [2x2x100 double]
    Impedance: 100
```

`rfparam(obj,i,j)` returns S-parameter S_{ij}

Convert Y-parameters to S-parameters

Extract Y-parameters from file `default.s2p`. Convert the resulting Y-parameters to S-parameters.

```
Y1 = yparameters('default.s2p');
S1 = sparameters(Y1,100);
disp(Y1)
disp(S1)
```

yparameters: Y-parameters object

```
    NumPorts: 2
    Frequencies: [191x1 double]
    Parameters: [2x2x191 double]
```

`rfparam(obj,i,j)` returns Y-parameter Y_{ij}

sparameters: S-parameters object

```
    NumPorts: 2
    Frequencies: [191x1 double]
    Parameters: [2x2x191 double]
    Impedance: 100
```

`rfparam(obj,i,j)` returns S-parameter S_{ij}

Convert RF Data Object to S-parameters

```
file = 'default.s2p';
h = read(rfdata.data, file);
S = sparameters(h)
```

```

S =

    sparameters: S-parameters object

        NumPorts: 2
    Frequencies: [191x1 double]
        Parameters: [2x2x191 double]
        Impedance: 50.0000 + 0.0000i

    rfparam(obj,i,j) returns S-parameter Sij

```

Input Arguments

data — S-parameter data

array of complex numbers

S-parameter data, specified as an array of complex numbers, of size N -by- N -by- K . The function uses this input argument to set the value of the `Parameters` property of `hs`.

cktobj — Circuit object

scalar handle object

Circuit object, specified as scalar handle object. The function uses this input argument to calculate the S-parameters of the circuit object.

Example: `hs = sparameters(hckt1, freq, 100);`

filename — Touchstone data file

string

Touchstone data file, specified as a string, that contains network parameter data. `filename` can be the name of a file on the MATLAB path or the full path to a file.

Example: `hs = sparameters('defaultbandpass.s2p');`

freq — S-parameter frequencies

vector of positive real numbers

S-parameter frequencies, specified as a vector of positive real numbers, sorted from smallest to largest. The function uses this input argument to set the value of the `Frequencies` property of `hs`.

Z0 — Reference impedance

50 (default) | positive real scalar

Reference impedance in ohms, specified as a positive real scalar. The function uses this input argument to set the value of the **Impedance** property of **hs**. You cannot specify **Z0** if you are importing data from a file. The argument **Z0** is optional and will be stored in the **Impedance** property.

When making a deep copy of an S-parameter object, this input argument is not supported. To change the reference impedance of an S-parameters object, use **newref**.

rftbxobj — network object

scalar handle

Network object, specified as scalar handle. Specify **rftbxobj** as one of the following types: **rfddata.data**, **rfddata.network**, and any analyzed **rfckt** type.

Example: `hs = sparameters(rfddata.data);`

Output Arguments

obj — S-parameter data

scalar handle

S-parameter data, returned as a scalar handle. **disp(hs)** returns the properties of the object:

- **NumPorts** — Number of ports, specified as an integer. The function calculates this value automatically when you create the object.
- **Frequencies** — S-parameter frequencies, specified as a K -by-1 vector of positive real numbers sorted from smallest to largest. The function sets this property from the **filename** or **freq** input arguments.
- **Parameters** — S-parameter data, specified as an N -by- N -by- K array of complex numbers. The function sets this property from the **filename** or **data** input arguments.
- **Impedance** — Reference impedance in ohms, specified as a positive real scalar. The function sets this property from the **filename** or **Z0** input arguments. If no reference impedance is provided, the function uses a default value of **50**.

See Also

abcdparameters | gparameters | hparameters | rfparam | rfplot |
yparameters | zparameters

abcdparameters

Create ABCD parameter object

Syntax

```
habcd = abcdparameters(filename)
habcd = abcdparameters(hnet)
habcd = abcdparameters(data, freq)
habcd = abcdparameters(rftbobj)
```

Description

`habcd = abcdparameters(filename)` creates an ABCD parameter object `habcd` by importing data from the Touchstone file specified by `filename`.

`habcd = abcdparameters(hnet)` creates an ABCD parameter object from the RF Toolbox network parameter object `hnet`.

`habcd = abcdparameters(data, freq)` creates an ABCD parameter object from the ABCD parameter data, `data`, and frequencies, `freq`.

`habcd = abcdparameters(rftbobj)` extracts network data from `rftbobj` and converts it into ABCD-parameter data.

Examples

Read a File as ABCD-parameters and Extract A

Read the file `default.s2p` as abcd-parameters

```
abcd = abcdparameters('default.s2p')
```

```
abcd =
```

```
abcdparameters: ABCD-parameters object
```

```
    NumPorts: 2  
    Frequencies: [191x1 double]  
    Parameters: [2x2x191 double]
```

```
rfparam(obj,specifier) returns specified ABCD-parameter 'A', 'B', 'C', or 'D'
```

Extract parameter A

```
A = rfparam(abcd, 'A');
```

Input Arguments

data — ABCD parameter data

array of complex numbers

ABCD parameter data, specified as an array of complex numbers, of size $2N$ -by- $2N$ -by- K . The function uses this input argument to set the value of the `Parameters` property of `habcd`.

filename — Touchstone data file

string

Touchstone data file, specified as a string, that contains network parameter data. `filename` can be the name of a file on the MATLAB path or the full path to a file.

```
Example: habcd = abcdparameters('defaultbandpass.s2p');
```

freq — ABCD parameter frequencies

vector of positive numbers

ABCD parameter frequencies, specified as a vector of positive real numbers, sorted from smallest to largest. The function uses this input argument to set the value of the `Frequencies` property of `habcd`.

hnet — Network parameter data

scalar handle

Network parameter data, specified as a scalar handle. If `hnet` is an ABCD parameter object, then `habcd` is a deep copy of `hnet`. Otherwise, the function performs a network

parameter conversion to create `habcd`. When converting network parameters, the same restrictions apply as those for RF Toolbox network parameter data conversion functions:

- ABCD parameter objects support $2N$ -port data.
- Hybrid-g parameter objects support 2-port data.
- Hybrid parameter objects support 2-port data.
- S-parameter objects support N -port data.
- Y-parameter objects support N -port data.
- Z-parameter objects support N -port data.

rftbobj — network object

scalar handle

Network object, specified as a scalar handle. Specify `rftbobj` as one of the following types: `rftdata.data`, `rftdata.network`, and any analyzed `rfckt` type.

Output Arguments

habcd — ABCD parameter data

scalar handle

ABCD parameter data, returned as a scalar handle. `disp(habcd)` returns the properties of the object:

- `NumPorts` — Number of ports, specified as an integer. The function calculates this value automatically when you create the object.
- `Frequencies` — ABCD parameter frequencies, specified as a K -by-1 vector of positive real numbers sorted from smallest to largest. The function sets this property from the `filename` or `freq` input arguments.
- `Parameters` — ABCD parameter data, specified as a $2N$ -by- $2N$ -by- K array of complex numbers. The function sets this property from the `filename` or `data` input arguments.

See Also

`gparameters` | `hparameters` | `rfparam` | `sparameters` | `yparameters` | `zparameters`

gparameters

Create hybrid-g parameter object

Syntax

```
hg = gparameters(filename)
hg = gparameters(hnet)
hg = gparameters(data, freq)
hg = gparameters(rftbxobj)
```

Description

`hg = gparameters(filename)` creates a hybrid-g parameter object `hg` by importing data from the Touchstone file specified by `filename`.

`hg = gparameters(hnet)` creates a hybrid-g parameter object from the RF Toolbox network parameter object `hnet`.

`hg = gparameters(data, freq)` creates a hybrid-g parameter object from the g-parameter data, `data`, and frequencies, `freq`.

`hg = gparameters(rftbxobj)` extracts network data from `rftbxobj` and converts it into G-parameter data.

Examples

Read File as G-parameters, Extract G11

Read the file `default.s2p` as g-parameters

```
g = gparameters('default.s2p')
```

```
g =
```

```
gparameters: g-parameters object

    NumPorts: 2
    Frequencies: [191x1 double]
    Parameters: [2x2x191 double]

rfparam(obj,i,j) returns g-parameter gij
```

Extract parameter g11

```
g11 = rfparam(g,1,1);
```

Input Arguments

data — Hybrid-g parameter data

array of complex numbers

Hybrid-g parameter data, specified as an array of complex numbers, of size $2N$ -by- $2N$ -by- K . The function uses this input argument to set the value of the `Parameters` property of `hg`.

filename — Touchstone data file

string

Touchstone data file, specified as a string, that contains network parameter data. `filename` can be the name of a file on the MATLAB path or the full path to a file.

```
Example: hg = gparameters('defaultbandpass.s2p');
```

freq — Hybrid-g parameter frequencies

vector of positive scalars

Hybrid-g parameter frequencies, specified as a vector of positive real numbers, sorted from smallest to largest. The function uses this input argument to set the value of the `Frequencies` property of `hg`.

hnet — Network parameter data

scalar handle

Network parameter data, specified as a scalar handle. If `hnet` is a hybrid-g parameter object, then `hg` is a deep copy of `hnet`. Otherwise, the function performs a network

parameter conversion to create `hg`. When converting network parameters, the same restrictions apply as those for RF Toolbox network parameter data conversion functions:

- ABCD parameter objects support $2N$ -port data.
- Hybrid-g parameter objects support 2-port data.
- Hybrid parameter objects support 2-port data.
- S-parameter objects support N -port data.
- Y-parameter objects support N -port data.
- Z-parameter objects support N -port data.

rftbobj — network object

scalar handle

Network object, specified as a scalar handle. Specify `rftbobj` as one of the following types: `rftdata.data`, `rftdata.network`, and any analyzed `rfckt` type.

Output Arguments

hg — Hybrid-g parameter data

scalar handle

Hybrid-g parameter data, returned as a scalar handle. `disp(hg)` returns the properties of the object:

- **Frequencies** — Hybrid-g parameter frequencies, specified as a K -by-1 vector of positive real numbers sorted from smallest to largest. The function sets this property from the `filename` or `freq` input arguments.
- **Parameters** — Hybrid-g parameter data, specified as an N -by- N -by- K array of complex numbers. The function sets this property from the `filename` or `data` input arguments.

See Also

`abcdparameters` | `hparameters` | `rfparam` | `sparameters` | `yparameters` | `zparameters`

hparameters

Create hybrid parameter object

Syntax

```
hh = hparameters(filename)
```

```
hh = hparameters(hnet)  
hh = hparameters(data, freq)
```

```
hh = hparameters(rftbxobj)
```

Description

`hh = hparameters(filename)` creates a hybrid parameter object `hh` by importing data from the Touchstone file specified by `filename`.

`hh = hparameters(hnet)` creates a hybrid parameter object from the RF Toolbox network parameter object `hnet`.

`hh = hparameters(data, freq)` creates a hybrid parameter object from the hybrid parameter data, `data`, and frequencies, `freq`.

`hh = hparameters(rftbxobj)` extracts network data from `rftbxobj` and converts it into H-parameter data.

Examples

Read File as H-parameters, Extract H11

Read the file `default.s2p` as h-parameters

```
h = hparameters('default.s2p')
```

```
h =
```



```
hparameters: h-parameters object

    NumPorts: 2
    Frequencies: [191x1 double]
    Parameters: [2x2x191 double]

rfparam(obj,i,j) returns h-parameter hij
```

Extract parameter h11

```
h11 = rfparam(h,1,1);
```

Input Arguments

data — Hybrid parameter data

array of complex numbers

Hybrid parameter data, specified as array of complex numbers, of size 2-by-2-by- K . The function uses this input argument to set the value of the `Parameters` property of `hh`.

filename — Touchstone data file

string

Touchstone data file, specified as a string, that contains network parameter data. `filename` can be the name of a file on the MATLAB path or the full path to a file.

```
Example: hh = hparameters('defaultbandpass.s2p');
```

freq — Hybrid parameter frequencies

vector of positive numbers

Hybrid parameter frequencies, specified as a vector of positive real numbers, sorted from smallest to largest. The function uses this input argument to set the value of the `Frequencies` property of `hh`.

hnet — Network parameter data

scalar handle

Network parameter data, specified as a scalar handle. If `hnet` is a hybrid parameter object, then `hh` is a deep copy of `hnet`. Otherwise, the function performs a network

parameter conversion to create `hh`. When converting network parameters, the same restrictions apply as those for RF Toolbox network parameter data conversion functions:

- ABCD parameter objects support $2N$ -port data.
- Hybrid-g parameter objects support 2-port data.
- Hybrid parameter objects support 2-port data.
- S-parameter objects support N -port data.
- Y-parameter objects support N -port data.
- Z-parameter objects support N -port data.

rftbxobj — network object

scalar handle

Network object, specified as scalar handle. Specify `rftbxobj` as one of the following types: `rftbxobj.data`, `rftbxobj.network`, and any analyzed `rfckt` type.

Output Arguments

hh — Hybrid parameter data

scalar handle

Hybrid parameter data, returned as a scalar handle. `disp(hh)` returns the properties of the object:

- **Frequencies** — Hybrid parameter frequencies, specified as a K -by-1 vector of positive real numbers sorted from smallest to largest. The function sets this property from the `filename` or `freq` input arguments.
- **Parameters** — Hybrid parameter data, specified as a 2-by-2-by- K array of complex numbers. The function sets this property from the `filename` or `data` input arguments.

See Also

`abcdparameters` | `gparameters` | `rfparam` | `sparameters` | `yparameters` | `zparameters`

yparameters

Create Y-parameter object

Syntax

```
hy = yparameters(filename)
```

```
hy = yparameters(hnet)  
hy = yparameters(data, freq)
```

```
hy = yparameters(rftbxobj)
```

Description

`hy = yparameters(filename)` creates a Y-parameter object `hy` by importing data from the Touchstone file specified by `filename`.

`hy = yparameters(hnet)` creates a Y-parameter object from the RF Toolbox network parameter object `hnet`.

`hy = yparameters(data, freq)` creates a Y-parameter object from the Y-parameter data, `data`, and frequencies, `freq`.

`hy = yparameters(rftbxobj)` extracts network data from `rftbxobj` and converts it into y-parameter data.

Examples

Extract Y-parameters, Plot On Smithchart

Extract y-parameters from a file

```
Y = yparameters('default.s2p');  
disp(Y)
```

```
yparameters: Y-parameters object
```

```
NumPorts: 2  
Frequencies: [191x1 double]  
Parameters: [2x2x191 double]
```

`rfparam(obj,i,j)` returns Y-parameter Y_{ij}

Plot parameter Y_{11} on a smithchart

```
figure;  
smith(Y,1,1)
```

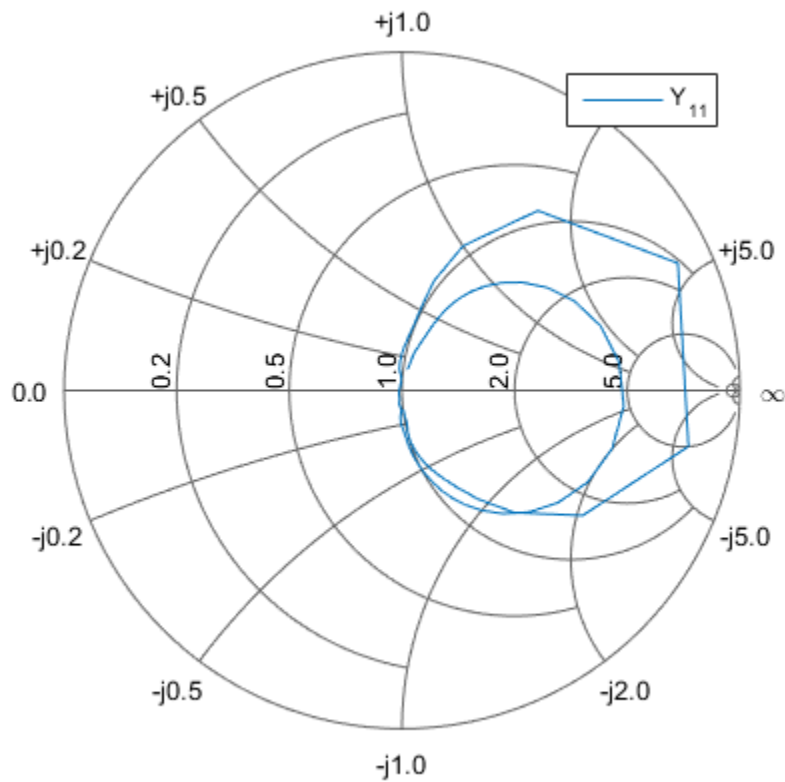

Extract Y_{21} and plot on a smithchart

```

y21 = rfparam(Y,2,1);
figure;
smith(Y,2,1)

```

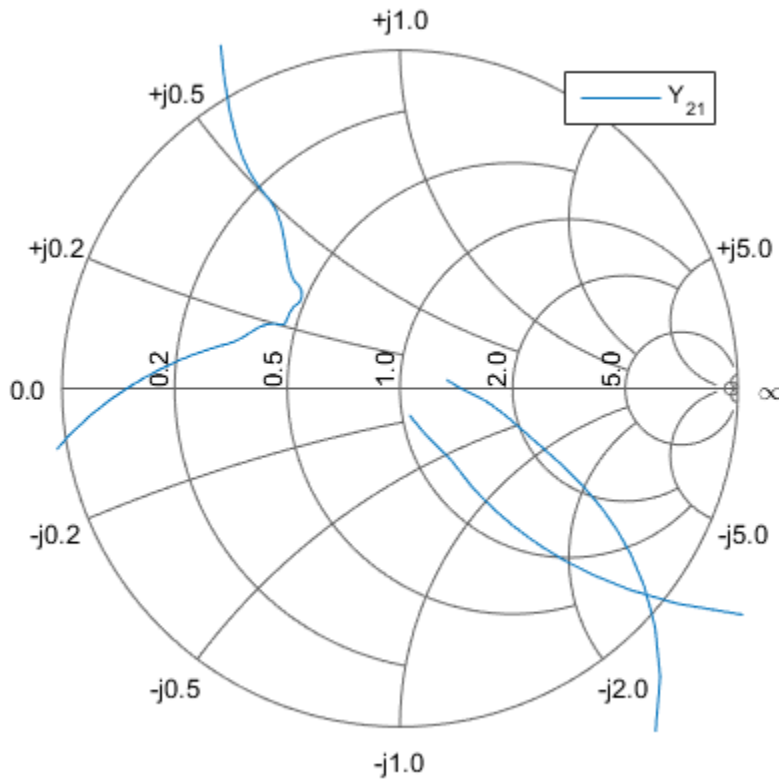

Input Arguments

data — Y-parameter data

array of complex numbers

Y-parameter data, specified as an array of complex numbers, of size N -by- N -by- K . The function uses this input argument to set the value of the `Parameters` property of `hy`.

filename — Touchstone data file

string

Touchstone data file, specified as a string, that contains network parameter data. **filename** can be the name of a file on the MATLAB path or the full path to a file.

Example: `hy = yparameters('defaultbandpass.s2p');`

freq — Y-parameter frequencies

vector of positive numbers

Y-parameter frequencies, specified as a vector of positive real numbers, sorted from smallest to largest. The function uses this input argument to set the value of the **Frequencies** property of **hy**.

hnet — Network parameter data

scalar handle

Network parameter data, specified as a scalar handle. If **hnet** is a Y-parameter object, then **hy** is a deep copy of **hnet**. Otherwise, the function performs a network parameter conversion to create **hy**. When converting network parameters, the same restrictions apply as those for RF Toolbox network parameter data conversion functions:

- ABCD parameter objects support $2N$ -port data.
- Hybrid-g parameter objects support 2-port data.
- Hybrid parameter objects support 2-port data.
- S-parameter objects support N -port data.
- Y-parameter objects support N -port data.
- Z-parameter objects support N -port data.

rftbxobj — network object

scalar

Network object, specified as scalar handle. Specify **rftbxobj** as one of the following types: `rftdata.data`, `rftdata.network`, and any analyzed `rfckt` type.

Output Arguments

hy — Y-parameter data

scalar handle

Y-parameter data, returned as a scalar handle. `disp(hy)` returns the properties of the object:

- **NumPorts** — Number of ports, specified as an integer. The function calculates this value automatically when you create the object.
- **Frequencies** — Y-parameter frequencies, specified as a K -by-1 vector of positive real numbers sorted from smallest to largest. The function sets this property from the `filename` or `freq` input arguments.
- **Parameters** — Y-parameter data, specified as an N -by- N -by- K array of complex numbers. The function sets this property from the `filename` or `data` input arguments.

See Also

`abcdparameters` | `gparameters` | `hparameters` | `rfparam` | `sparameters` | `zparameters`

zparameters

Create Z-parameter object

Syntax

```
hz = zparameters(filename)
```

```
hz = zparameters(hnet)  
hz = zparameters(data, freq)  
hz = zparameters( ____, Z0)
```

```
hz = zparameters(rftbxobj)
```

Description

`hz = zparameters(filename)` creates a Z-parameter object `hz` by importing data from the Touchstone file specified by `filename`.

`hz = zparameters(hnet)` creates a Z-parameter object from the RF Toolbox network parameter object `hnet`.

`hz = zparameters(data, freq)` creates a Z-parameter object from the Z-parameter data, `data`, and frequencies, `freq`.

`hz = zparameters(____, Z0)` creates a Z-parameter object using the previously described syntax, with a reference impedance of `Z0`.

`hz = zparameters(rftbxobj)` extracts network data from `rftbxobj` and converts it into z-parameter data.

Examples

Read File as Z-parameters, Extract Z11, Plot Imaginary Part of Z11

Read the file `defaultbandpass.s2p` as z-parameters.

```
Z = zparameters('defaultbandpass.s2p')
```

```
Z =
```

```
zparameters: Z-parameters object
```

```
  NumPorts: 2
```

```
  Frequencies: [1000x1 double]
```

```
  Parameters: [2x2x1000 double]
```

```
rfparam(obj,i,j) returns Z-parameter Zij
```

Extract parameter z11.

```
z11 = rfparam(Z,1,1);
```

Plot imaginary part of z11.

```
plot(Z.Frequencies, imag(z11))
```

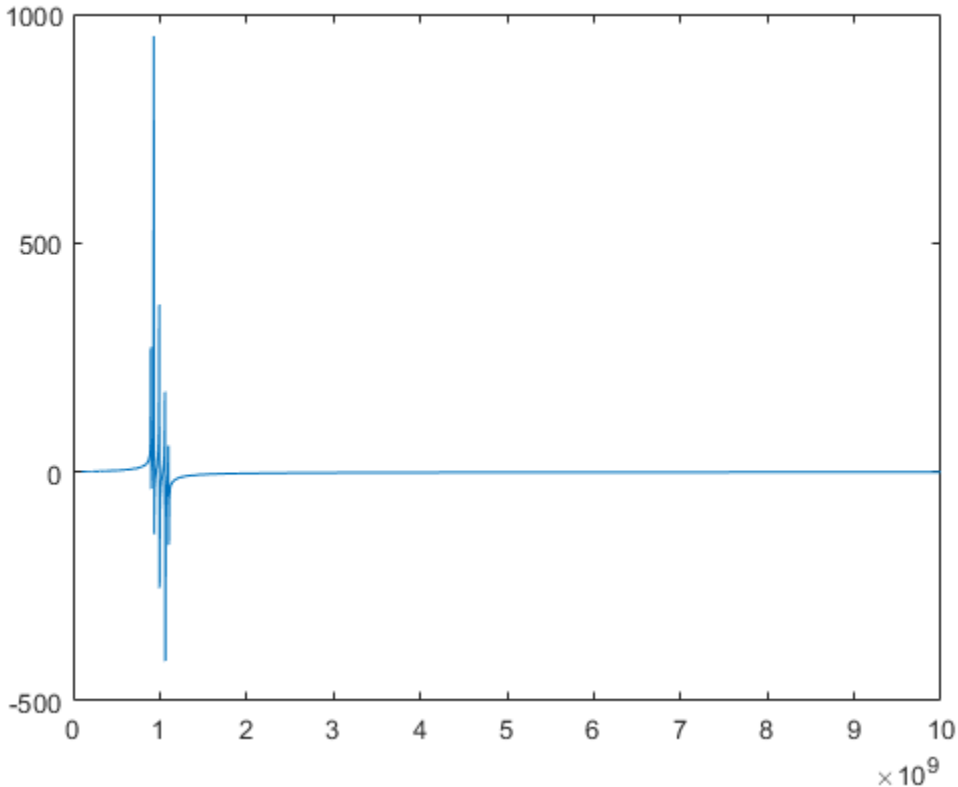

Input Arguments

data — Z-parameter data

array of complex numbers

Z-parameter data, specified as an array of complex numbers, of size N -by- N -by- K . The function uses this input argument to set the value of the `Parameters` property of `hz`.

filename — Touchstone data file that contains network parameter data

string

Touchstone data file, specified as a string. `filename` can be the name of a file on the MATLAB path or the full path to a file.

Example: `hz = zparameters('defaultbandpass.s2p');`

freq — Z-parameter frequencies

vector of positive numbers

Z-parameter frequencies, specified as a vector of positive real numbers, sorted from smallest to largest. The function uses this input argument to set the value of the `Frequencies` property of `hz`.

hnet — Network parameter data

scalar handle

Network parameter data, specified as a scalar handle. If `hnet` is a Z-parameter object, then `hz` is a deep copy of `hnet`. Otherwise, the function performs a network parameter conversion to create `hz`. When converting network parameters, the same restrictions apply as those for RF Toolbox network parameter data conversion functions:

- ABCD parameter objects support $2N$ -port data.
- Hybrid-g parameter objects support 2-port data.
- Hybrid parameter objects support 2-port data.
- S-parameter objects support N -port data.
- Y-parameter objects support N -port data.
- Z-parameter objects support N -port data.

rftbxobj — network object

scalar

Network object, specified as scalar handle. Specify `rftbxobj` as one of the following types: `rftdata.data`, `rftdata.network`, and any analyzed `rfckt` type.

Output Arguments

hz — Z-parameter object

scalar handle

Z-parameter data, returned as a scalar handle. `disp(hz)` returns the properties of the object:

- **NumPorts** — Number of ports, specified as an integer. The function calculates this value automatically when you create the object.
- **Frequencies** — Z -parameter frequencies, specified as a K -by-1 vector of positive real numbers sorted from smallest to largest. The function sets this property from the `filename` or `freq` input arguments.
- **Parameters** — Z -parameter data, specified as an N -by- N -by- K array of complex numbers. The function sets this property from the `filename` or `data` input arguments.

See Also

`abcdparameters` | `gparameters` | `hparameters` | `rfparam` | `sparameters` | `yparameters`

tparameters

Create T-parameter object

Syntax

```
tobj = tparameters(filename)
tobj = tparameters(tobj_old,z0)

tobj = tparameters(rftbx_obj)
tobj = tparameters(hnet, z0)
tobj = tparameters(paramdata,freq,z0)
```

Description

`tobj = tparameters(filename)` creates a T-parameter object, `ht` by importing data from the Touchstone file specified by `filename`.

`tobj = tparameters(tobj_old,z0)` converts a T-parameter data in `tobj_old` to the new impedance Z_0 . Z_0 is optional, and if not provided, `tparam_data` is copied instead of converted.

`tobj = tparameters(rftbx_obj)` extracts S-parameter network data from `rfddata.network` object, an `rfddata.data` object, or any analyzed network object, and then converts the data to T-parameter data.

`tobj = tparameters(hnet, z0)` converts the network parameter data in `hnet` into T-parameter data.

`tobj = tparameters(paramdata,freq,z0)` creates T-parameter object directly from the specified data, `paramdata` using specified frequency and impedance.

Examples

Convert File to T-Parameters

Read S-parameter data from a Touchstone file and convert the data to T-parameters

```
T1 = tparameters('passive.s2p');
```

```
disp(T1)
```

```
  tparameters: T-parameters object
```

```
    NumPorts: 2  
    Frequencies: [202x1 double]  
    Parameters: [2x2x202 double]  
    Impedance: 50
```

```
  rfparam(obj,i,j) returns T-parameter Tij
```

Change Impedance of T-Parameters

Change the impedance of T-parameters to 100 ohms.

```
T1 = tparameters('passive.s2p');  
disp(T1)  
T2 = tparameters(T1,100);  
disp(T2)
```

```
  tparameters: T-parameters object
```

```
    NumPorts: 2  
    Frequencies: [202x1 double]  
    Parameters: [2x2x202 double]  
    Impedance: 50
```

```
  rfparam(obj,i,j) returns T-parameter Tij
```

```
  tparameters: T-parameters object
```

```
    NumPorts: 2  
    Frequencies: [202x1 double]  
    Parameters: [2x2x202 double]  
    Impedance: 100
```

```
  rfparam(obj,i,j) returns T-parameter Tij
```

Input Arguments

tobj_old — T-parameter object
scalar handle

T-parameter object, specified as a scalar handle.

paramdata — Input T-parameter data

2-by-2-by- K array of complex numbers

Input T-parameter data, specified as 2-by-2-by- K array of complex numbers. The function uses this input argument to set the value of the `Parameters` property of `ht`.

filename — Touchstone data file

string

Touchstone data file, specified as a string. `filename` can be the name of a file on the MATLAB path or the full path to a file.

Example: `ht = tparameters('defaultbandpass.s2p');`

freq — T-parameter frequencies

vector of positive real numbers

T-parameter frequencies, specified as a vector of positive real numbers. The frequencies are sorted from smallest to largest. The function uses this input argument to set the value of the `Frequencies` property of `ht`.

z0 — T-parameter impedance

50 (default) | scalar

T-parameter impedance, specified as a scalar. z_0 is optional and is stored in the `Impedance`.

hnet — Network parameter data

scalar handle

Network parameter data, specified as a scalar handle. If `hnet` is a T-parameter object, then `tobj` is a deep copy of `hnet`. Otherwise, the function performs a network parameter conversion to create `tobj`. Specify `hnet` as one of the following types: `sparameters`, `yparameters`, `gparameters`, `hparameters`, `zparameters`, or `abcdparameters`.

rftbx_obj — network object

scalar handle

Network object, specified as a scalar handle. You can specify `rftbxobj` as one of the following types: `rfddata.data` object, `rfddata.network` object, or as any analyzed `rfckt` type.

Output Arguments

tobj — T-parameter object

scalar handle

T-parameter data, returned as a scalar handle. `disp(ht)` returns the properties of the object:

- **NumPorts** — Number of ports, specified as an integer. The function calculates this value automatically when you create the object.
- **Parameters** — T-parameter data, specified as a 2-by-2-by- K array of complex numbers. The 2x2 Tparameter data is specified for each frequency in the “Frequencies” property. The function sets this property from the `filename` or `paramdata` input arguments.
- **Impedance** — Characteristic impedance used to measure the T-Parameters, specified as a numeric positive real scalar.
- **Frequencies** — T-parameter frequencies, specified as a K -by-1 vector of positive real numbers sorted from smallest to largest. The function sets this property from the `filename` or `freq` input arguments.

See Also

`abcdparameters` | `gparameters` | `hparameters` | `rfparam` | `sparameters` | `yparameters` | `zparameters`

add

Insert circuit element or circuit object into circuit

Syntax

```
add(cktobj,cktnodes,elem)
add(cktobj,cktnodes,elem,termorder)
```

```
elem = add(____)
```

Description

`add(cktobj,cktnodes,elem)` inserts a circuit element `elem` into a circuit object `cktobj`. The terminals of the `elem` are attached to the nodes specified in `cktnodes`. If `elem` is a Touchstone file name or s-parameters object, an `nport` object is created from input and added to `cktobj`.

`add(cktobj,cktnodes,elem,termorder)` the terminals specified in `termorder` are attached to circuit nodes specified in `cktnodes`.

`elem = add(____)` returns `elem` as an output.

Examples

Add Element to Circuit

Create a resistor, and add it to a circuit.

```
R1 = resistor(50);
cktres1 = circuit('new_circuit1');
add(cktres1,[1 2],R1)
disp(R1)
disp(cktres1)
```

```
resistor: Resistor element
    Resistance: 50
      Name: 'R'
    Terminals: {'p' 'n'}
  ParentNodes: [1 2]
  ParentPath: 'new_circuit1'

circuit: Circuit element
    ElementNames: {'R'}
      Nodes: [1 2]
    Name: 'new_circuit1'
```

Add Element to Specific Nodes of Circuit

Create a capacitor. Then, connect terminal n of the capacitor to node 3 and terminal p of the capacitor to node 4.

```
C1 = capacitor(1e-10);
cktcap1 = circuit('new_circuit2');
add(cktcap1,[3 4],C1,{'n' 'p'})
disp(C1)
disp(cktcap1)
```

```
capacitor: Capacitor element
    Capacitance: 1.0000e-10
      Name: 'C'
    Terminals: {'p' 'n'}
  ParentNodes: [4 3]
  ParentPath: 'new_circuit2'

circuit: Circuit element
    ElementNames: {'C'}
      Nodes: [3 4]
    Name: 'new_circuit2'
```

Create and Insert Element in Circuit

Create a circuit and insert an inductor into it using the add function.

```
cktind1 = circuit('new_circuit3');
L1 = add(cktind1,[100 200],inductor(1e-9));
disp(L1)
disp(cktind1)
```

```
inductor: Inductor element

    Inductance: 1.0000e-09
      Name: 'L'
  Terminals: {'p' 'n'}
ParentNodes: [100 200]
ParentPath: 'new_circuit3'

circuit: Circuit element

ElementNames: {'L'}
      Nodes: [100 200]
      Name: 'new_circuit3'
```

Add Two Circuits Together

Create two circuits. Set the terminals of the child circuit using the `setterminals` functions before adding it to the parent circuit. Display both circuits.

```
hcktadd1 = circuit('circuit_new1');
add(hcktadd1,[1 2], resistor(100));
setterminals(hcktadd1, [1 2]);
hcktadd2 = circuit('circuit_new2');
add(hcktadd2, [3 4], capacitor(1.5e-9));
setterminals(hcktadd2, [3 4]);
add(hcktadd1, [2 4], hcktadd2);
disp(hcktadd2)
disp(hcktadd1)
```

```
circuit: Circuit element

ElementNames: {'C'}
      Nodes: [3 4]
      Name: 'circuit_new2'
  Terminals: {'t1' 't2'}
ParentNodes: [2 4]
ParentPath: 'circuit_new1'
```

```
circuit: Circuit element  
  
ElementNames: {'R' 'circuit_new2'}  
Nodes: [1 2 4]  
Name: 'circuit_new1'  
Terminals: {'t1' 't2'}
```

Input Arguments

cktobj — Circuit object

scalar handle object

Circuit object into which the circuit element is inserted, specified as scalar handle object. This circuit object can be a new circuit or a nport object, or an already existing circuit.

cktnodes — Circuit nodes

vector of integers

Circuit nodes of the circuit object, specified as vector of integers. The function uses this input argument to attach the new element to the circuit.

elem — Circuit elements

scalar handle objects

Circuit elements that are inserted into the circuit object, specified as scalar handle objects. The element can be a resistor, capacitor, inductor, Touchstone file name, s-parameter object, or an entire circuit.

termorder — Element terminals

vector of strings

Element terminals, which are the same strings found in `Terminals` property of `elem`. These input arguments are specified as scalar handle objects. .

Output Arguments

elem — Circuit elements

scalar handle objects

Circuit elements, which are returned as scalar handle objects, after using the add function. The function uses any or all of the input arguments to create these circuit element.

See Also

clone | setports | setterminals | sparameters

setports

Set ports of circuit object

Syntax

```
setports(cktobj,nodepair_1,.....,nodepair_n)
setports(cktobj,nodepair_1,.....,nodepair_n,portnames)
```

Description

`setports(cktobj,nodepair_1,.....,nodepair_n)` defines the `node_pairs` in an N-port `cktobj` as ports using `nodepair_1,.....,nodepair_n`. This syntax then assigns the ports default names. It also defines the terminals of a `cktobj`, taking the terminal names from the port names. If any of the node pairs do not exist, `setports` creates it.

`setports(cktobj,nodepair_1,.....,nodepair_n,portnames)` defines the `node_pairs` in an N-port `cktobj` as ports using `nodepair_1,.....,nodepair_n`. After defining the ports, this syntax names them using `portnames`. The length of the `portnames` must equal to the number of `node_pairs` in the circuit.

Examples

Create a 1 – Port Circuit with Default Names

```
hcktport1 = circuit('new_circuit1');
add(hcktport1,[1 2],resistor(50))
setports(hcktport1,[1 2])
disp(hcktport1)
```

```
circuit: Circuit element
```

```
    ElementNames: {'R'}
           Nodes: [1 2]
           Name: 'new_circuit1'
```

```

Ports: {'p1'}
Terminals: {'p1+' 'p1-'}

```

Create a 2 – Port Circuit and Assign Port Names

Create a circuit and define two ports. Name the ports `in` and `out`.

```

hcktport2 = circuit('new_circuit2');
add(hcktport2,[2 3],resistor(50))
add(hcktport2,[3 1],capacitor(1e-9))
setports(hcktport2,[2 1],[3 1],{'in' 'out'})
disp(hcktport2)

circuit: Circuit element

ElementNames: {'R' 'C'}
Nodes: [1 2 3]
Name: 'new_circuit2'
Ports: {'in' 'out'}
Terminals: {'in+' 'out+' 'in-' 'out-'}

```

Input Arguments

cktobj – Circuit Object

scalar handle object

Circuit object for which the ports are defined, specified as scalar handle objects.

nodepair_1,.....,nodepair_n – Node pairs

vector of integers

Node pairs of the circuit object, specified as vector of integers. The function uses this input argument to define the ports.

portnames – Port names

cell vector of strings

Names to name the ports defined for the circuit object, specified as cell vector of strings.

See Also

`add` | `clone` | `setterminals` | `sparameters`

setterminals

Set terminals of circuit object

Syntax

```
setterminals(cktobj,cktnodes)  
setterminals(cktobj,cktnodes,termnames)
```

Description

`setterminals(cktobj,cktnodes)` defines the nodes in a `cktobj` as terminals using `cktnodes`. It then gives the terminals default names.

`setterminals(cktobj,cktnodes,termnames)` defines the nodes in a `cktobj` as terminals `cktnodes`. It then names the terminals using `termnames`. `cktnodes` and `termnames` must be same length.

Examples

Create a Circuit and Define Its Nodes as Terminals

Create a circuit names `new_circuit1` and a add a resistor and capacitor to it. Set the terminals of this circuit.

```
hcktnode1 = circuit('new_circuit1');  
add(hcktnode1,[1 2],resistor(50))  
add(hcktnode1,[2 3],capacitor(1e-9))  
setterminals(hcktnode1,[1 3])  
disp(hcktnode1)
```

```
circuit: Circuit element  
  
ElementNames: {'R' 'C'}  
Nodes: [1 2 3]
```



```
Name: 'new_circuit1'
Terminals: {'t1' 't2'}
```

Create a Circuit and Define Its Nodes as Terminals Using Names

Create a circuit and add three resistors to it. Set terminals of the circuit by using (a, b, c) as `termnames`.

```
hcktnode2 = circuit('new_circuit2');
add(hcktnode2,[1 2],resistor(50))
add(hcktnode2,[1 3],resistor(50))
add(hcktnode2,[1 4],resistor(50))
setterminals(hcktnode2,[2 3 4],{'a' 'b' 'c'})
disp(hcktnode2)
```

```
circuit: Circuit element

ElementNames: {'R' 'R_1' 'R_2'}
Nodes: [1 2 3 4]
Name: 'new_circuit2'
Terminals: {'a' 'b' 'c'}
```

Add Two Circuits Together

Create two circuits. Set the terminals of the child circuit using the `setterminals` functions before adding it to the parent circuit. Display both the circuits.

```
hcktadd1 = circuit('circuit_new1');
add(hcktadd1,[1 2], resistor(100));
setterminals(hcktadd1, [1 2]);
hcktadd2 = circuit('circuit_new2');
add(hcktadd2, [3 4], capacitor(1.5e-9));
setterminals(hcktadd2, [3 4]);
add(hcktadd1, [2 4], hcktadd2);
disp(hcktadd2)
disp(hcktadd1)
```

```
circuit: Circuit element

ElementNames: {'C'}
Nodes: [3 4]
```

```
        Name: 'circuit_new2'  
        Terminals: {'t1' 't2'}  
    ParentNodes: [2 4]  
    ParentPath: 'circuit_new1'  
  
circuit: Circuit element  
  
    ElementNames: {'R' 'circuit_new2'}  
        Nodes: [1 2 4]  
        Name: 'circuit_new1'  
    Terminals: {'t1' 't2'}
```

Input Arguments

cktobj — Circuit object

scalar handle object

Circuit object for which the terminals are defined, specified as a scalar handle object.

cktnodes — Circuit nodes

vector of integers

Circuit nodes, used by the function to define the terminals of the circuit, specified as a vector of integers.

termnames — Names

cell vector of strings

Names, used to identify the terminals defined for the circuit object, specified as cell vector of strings.

See Also

[add](#) | [clone](#) | [setports](#) | [sparameters](#)

clone

Create copy of existing circuit element or circuit object

Syntax

```
outelem = clone(inelem)
outckt = clone(inckt)
```

Description

`outelem = clone(inelem)` creates a circuit element, `outelem`, with identical properties as `inelem`. The clone does not copy information about the parent circuit such as `ParentNodes` and `ParentPath`.

`outckt = clone(inckt)` creates a circuit object, `outckt`, identical to `inckt`. Circuit elements in the `inckt` are cloned recursively and added to the same nodes in the `outckt`. The ports or terminals in the `outckt` are defined same as `inckt`.

Examples

Create an Element and Clone It

Create a resistor element and clone it.

```
hRclone1 = resistor(50);
hRclone2 = clone(hRclone1);
disp (hRclone1)
disp (hRclone2)

resistor: Resistor element

Resistance: 50
Name: 'R'
Terminals: {'p' 'n'}
```

```
resistor: Resistor element  
  
Resistance: 50  
Name: 'R'  
Terminals: {'p' 'n'}
```

Create an Circuit and Clone it

Create a circuit object. Add a resistor and capacitor to it. Clone the circuit object.

```
hcktclone1 = circuit('circuit1');  
hCclone1= add(hcktclone1,[1 2],capacitor(3e-9));  
hRclone1 = add(hcktclone1,[2 3],resistor(100));  
hcktclone2 = clone(hcktclone1);  
disp(hcktclone1)  
disp (hcktclone2)  
  
circuit: Circuit element  
  
ElementNames: {'C' 'R'}  
Nodes: [1 2 3]  
Name: 'circuit1'  
  
circuit: Circuit element  
  
ElementNames: {'C' 'R'}  
Nodes: [1 2 3]  
Name: 'circuit1'
```

Input Arguments

inelem — Circuit element

scalar handle object

Circuit element to be cloned, specified as scalar handle object. The circuit element can be a resistor, capacitor, or inductor.

inckt — Circuit object

scalar handle object

Circuit object to be cloned, specified as scalar handle object.

Output Arguments

outelem — Circuit element

scalar handle object

Cloned circuit element, returned as scalar handle object. The circuit element can be a resistor, capacitor, or inductor.

outckt — Circuit object

scalar handle object

Cloned circuit object, returned as scalar handle object.

See Also

[add](#) | [setports](#) | [setterminals](#) | [sparameters](#)

rfwrite

Write RF network data to Touchstone file

Syntax

```
rfwrite(data, freq, filename)
rfwrite(netobj, filename)
rfwrite(_____, Name, Value)
```

Description

`rfwrite(data, freq, filename)` creates a Touchstone data file, `filename`.

`rfwrite(netobj, filename)` creates a Touchstone file from a network parameter object, `netobj`.

`rfwrite(_____, Name, Value)` creates a Touchstone file using the options in the name-value pair arguments following the `filename`.

Examples

Write a Touchstone File Using Data and Frequency Values

Write a new Touchstone file from file `default.s2p` using `data` as `S50.Parameters` and `freq` as `S50.Frequencies`. The output is stored in `defaultnew.s2p`.

```
S50 = sparameters('default.s2p');
data = S50.Parameters;
freq = S50.Frequencies;
rfwrite(data, freq, 'defaultnew.s2p')
```

Write a Touchstone File Using Network Object Parameters

Convert an existing Touchstone file `passive.s2p` to S-parameters with a new resistance value. Write a Touchstone file `passive100.s2p` using the new S-parameters.

```
S50 = sparameters('passive.s2p');  
S100 = newref(S50,100);  
rfwrite(S100, 'passive100.s2p');
```

Write a Touchstone File Using Name-Value Pair Arguments

Convert an existing Touchstone file `passive.s2p` to S-parameters with a new resistance value. Write a Touchstone file `passive150.s2p` in MHz using the new S-parameters.

```
S50 = sparameters('passive.s2p');  
S150 = newref(S50,150);  
rfwrite(S150, 'passive150.s2p', 'FrequencyUnit', 'MHz');
```

Write a Touchstone File Using Y-Parameters

Convert an existing Touchstone file `passive.s2p` to Y-parameters. Write a Touchstone file `passive.y2p` in MHz using the new Y-parameters.

```
Y50 = yparameters('passive.s2p');  
rfwrite(Y50, 'passive.y2p', 'FrequencyUnit', 'MHz');
```

Input Arguments

data — Number of ports and frequencies

matrix

Number of ports and frequencies, specified as an N-by-N-by-K matrix, to create Touchstone file. N is the number of ports of data to be written. K is the number of frequencies.

Example: 2x2x20 complex double

Data Types: double

Complex Number Support: Yes

freq — Value of frequencies

numeric vector

Value of frequencies, specified as a numeric vector of length K, represents the value of frequencies in Hz.

Example: 202 x 1 double

Data Types: double

filename — Name of Touchstone file

string

Name of a Touchstone file, specified as a string.

Example: default.s2p

Data Types: char

netobj — Network parameter object

scalar

Network parameter object, specified as a scalar, to create Touchstone file. The `netobj` can be any one of the following types s-parameters, y-parameters, z-parameters, h-parameters, g-parameters, or abcd-parameters.

Example: 1x1 S-parameters

Data Types: double

Complex Number Support: Yes

Name-Value Pair Arguments

Optional comma-separated pairs of `Name`, `Value` arguments, where `Name` is the argument name and `Value` is the corresponding value. `Name` must appear inside single quotes (' ').

Example: `rfwrite(S150, 'passive150.s2p', 'FrequencyUnit', 'MHz')`

'FrequencyUnit' — Scaling unit for frequency values

GHz (default) | Mhz | KHz | Hz

Scaling unit for frequency value, specified as a comma-separated pair consisting of 'Frequency Unit' and any one of the values shown in value summary.

Example: 3.150746640000000e-04

Data Types: double

'Parameter' — Network parameter type

S (default) | Y | Z | h | g

Network parameter type, specified as a comma-separated pair consisting of 'Parameter' and any one of the values shown in value summary. This pair determines the parameter type the data has to be converted into in the Touchstone file.

Example: 0.0018 + 0.0122i 0.9981 - 0.0127i 0.9984 - 0.0131i 0.0017 + 0.0123i

Data Types: double

Complex Number Support: Yes

'Format' — File storage format

MA (Magnitude Angle) (default) | DB (Decibel) | RI (Real Imaginary)

File storage format, specified as a comma-separated pair consisting of 'Format' any one of the values shown in value summary. This pair determines the format to store the Touchstone file.

Example: MA

'ReferenceResistance' — Resistance

50 (default) | positive scalar (Ohm)

Reference resistance, specified as a comma-separated pair consisting of 'ReferenceResistance' and a positive scalar.

Example: 100

Data Types: double

See Also

report | show | sparameters | write

addstage

Class: rfchain

Add stage to RF chain object

Syntax

```
addstage(obj,g,nf,oip3val,'Name',nm)
```

```
addstage(obj,g,nf,'IIP3',ip3val,'Name',nm)
```

```
addstage(_____,Name,Value)
```

Description

`addstage(obj,g,nf,oip3val,'Name',nm)` adds a stage to the RF chain object `obj`. This syntax also specifies the gain, noise figure, output-referred third-order intercept and name of the RF chain object `obj`. You must specify the stage name using name-value pair arguments.

`addstage(obj,g,nf,'IIP3',ip3val,'Name',nm)` adds a stage having input-referred third-order intercept of value `i3` to the RF chain object `obj`. You must specify the IIP3 value and stage name using name-value pair arguments.

`addstage(_____,Name,Value)` adds a new stage having properties specified by one or more name-value pair arguments. Properties not specified are given their default values.

Input Arguments

obj — RF chain object

scalar handle

RF chain object, specified as a scalar handle.

g — Gain

0 (default) | scalar | vectors of same length

Gain of a stage, specified as a scalar or vectors of same length.

Example: 11

Data Types: double

nf — Noise figure

0 (default) | scalar | vectors of same length

Noise figure of a stage, specified as a scalar or vectors of same length.

Example: 25

Data Types: double

oip3va1 — Output-referred third-order intercept

Inf (default) | scalar | vectors of same length

Output-referred third-order intercept of a stage, specified as a scalar or vectors of same length.

Example: 30

Data Types: double

Name-Value Pair Arguments

Optional comma-separated pairs of **Name**, **Value** pair arguments, where **Name** is the argument name and **Value** is the corresponding value. **Name** must appear inside single quotes (' ').

Example: `addstage(ch,2,'NoiseFigure',20,'Name','ln1')`

'Gain' — Gain

0 (default) | scalar | vectors of same length

Gain of a stage, specified as a comma-separated pair consisting of 'Gain' and a scalar or vectors of same length.

Example: 10

Data Types: double

'NoiseFigure' — Noise figure

0 (default) | non-negative scalar | vectors of same length

Noise figure of a stage, specified as a comma-separated pair consisting of 'NoiseFigure' and a non-negative scalar or vectors of same length.

Example: 30

Data Types: double

'OIP3' — Output-referred third-order intercept

Inf (default) | scalar | vectors of same length

Output-referred third-order intercept of a stage, specified as a comma-separated pair consisting of 'OIP3' and a scalar or vectors of same length.

Example: 30

Data Types: double

'IIP3' — Input-referred third-order intercept

Inf (default) | scalar | vectors of same length

Input-referred third-order intercept of a stage, specified as a comma-separated pair consisting of 'Name' and a scalar or vectors of same length.

Example: 30

Data Types: double

'Name' — Name of stage

string

Name of a stage, specified as a comma-separated pair consisting of 'Name' and a string.

Example: amp1

Data Types: char

Examples

Add Stages to RF Chain

Create an RF chain object `rfch` and view it.

```
rfch = rfchain
```

```
rfch =
```

rfchain with properties:

```
Gain: []
NoiseFigure: []
OIP3: []
IIP3: []
Name: {}
NumStages: 0
```

Use [worksheet](matlab:worksheet(rfch)) or [plot](matlab:plot(rfch))

Add stage 1 with default name and IIP3.

```
addstage(rfch,11,25);
```

Add stage 2 with default noise figure.

```
addstage(rfch,-3,'IIP3', 10, 'Name','filt1');
```

View results on a worksheet.

```
worksheet(rfch)
```

	stage1	filt1
Stage Gain	11	-3
Stage Noise Figure	25	0
Stage OIP3	Inf	7
Stage IIP3	Inf	10
Cascaded Gain	11	8
Cascaded Noise Figure	25	25
Cascaded OIP3	Inf	7.0000
Cascaded IIP3	Inf	-1.0000

Add Stages to RF Chain Using Name-Value Pairs

Create an RF chain object with handle `rfch` and view it.

```
rfch = rfchain
```

```
rfch =
```

```
rfchain with properties:
```

```
Gain: []
NoiseFigure: []
OIP3: []
IIP3: []
Name: {}
NumStages: 0
```

Use [worksheet](matlab:worksheet(rfch)) or

Add stage 1 with OIP3.

```
addstage(rfch, 'Gain', 10, 'NoiseFigure', 20, 'OIP3', 30, 'Name', 'amp1');
```

Add stage 2 with IIP3.

```
addstage(rfch, 'Gain', 8, 'NoiseFigure', 22, 'IIP3', 20, 'Name', 'amp2');
```

View results on a worksheet.

```
worksheet(rfch)
```

	amp1	amp2
Stage Gain	10	8
Stage Noise Figure	20	22
Stage OIP3	30	28
Stage IIP3	20	20
Cascaded Gain	10	18
Cascaded Noise Figure	20	20.6352
Cascaded OIP3	30	27.5861
Cascaded IIP3	20	9.5861

See Also

cumgain | cumiip3 | cumnoisefig | cumoip3 | plot | setstage | worksheet

setstage

Class: rfchain

Update RF chain stage

Syntax

```
setstage(obj, idx, g, nf, oip3val, 'Name', nm)
```

```
setstage(obj, g, nf, 'IIP3', ip3val, 'Name', nm)
```

```
setstage(____, Name, Value)
```

Description

`setstage(obj, idx, g, nf, oip3val, 'Name', nm)` updates gain, noise figure, output-referred third-order intercept values of a stage. Use the index, `idx` of the RF chain object to specify the stage you want to update. At a time, you can change the name of only one stage.

`setstage(obj, g, nf, 'IIP3', ip3val, 'Name', nm)` updates the input-referred third-order intercept value of a stage.

`setstage(____, Name, Value)` updates the values of a stage using the name-value pair arguments.

Input Arguments

obj — RF chain object

scalar handle

RF chain object, specified as a scalar handle.

idx — Number of a stage

integer | vector of integers

Number of a stage, specified as an integer or vector of integers.

Example: 2

Data Types: double

g — Gain

0 (default) | scalar | vectors of same length

Gain of a stage, specified as a scalar or vectors of same length.

Example: -3

Data Types: double

nf — Noise figure

0 (default) | scalar | vectors of same length

Noise figure of a stage, specified as a scalar or vectors of same length.

Example: 20

Data Types: double

oip3va1 — Output-referred third-order intercept

Inf (default) | scalar | vectors of same length

Output-referred third-order intercept of a stage, specified as a scalar or vectors of same length.

Example: 30

Data Types: double

Name-Value Pair Arguments

Optional comma-separated pairs of **Name**, **Value** pair arguments, where **Name** is the argument name and **Value** is the corresponding value. **Name** must appear inside single quotes (' ').

Example: setstage(ch,2,'NoiseFigure',20)

'Gain' — Gain

0 (default) | scalar | vectors of same length

Gain of a stage, specified as a comma-separated pair consisting of 'Gain' and a scalar or vectors of same length. This pair updates the gain of a stage specified by `idx`.

Example: 10

Data Types: double

'NoiseFigure' — Noise figure

0 (default) | scalar | vectors of same length

Noise figure of a stage, specified as a comma-separated pair consisting of 'NoiseFigure' and a scalar or vectors of same length. This pair updates the noise figure of a stage specified by `idx`.

Example: 30

Data Types: double

'OIP3' — Output-referred third-order intercept

Inf (default) | scalar | vectors of same length

Output-referred third-order intercept of a stage, specified as a comma-separated pair consisting of 'OIP3' and a scalar or vectors of same length. This pair updates the output-referred third-order intercept of a stage specified by `idx`.

Example: 30

Data Types: double

'IIP3' — Input-referred third-order intercept

Inf (default) | scalar | vectors of same length

Input-referred third-order intercept of a stage, specified as a comma-separated pair consisting of 'IIP3' and a scalar or vectors of same length. This pair updates the input-referred third-order intercept of a stage specified by `idx`.

Example: 30

Data Types: double

'Name' — Name of stage

string

Name of a stage, specified as a comma-separated pair consisting of 'Name' and a string. This pair updates the name of the stage specified by `idx`.

Example: amp1

Examples

Change Noise Figure Of RF Chain Stage

Create an RF chain object rfch.

```
g = [11 -3];
nf = [25 3];
o3 = [30 Inf];
nm = {'amp1', 'filt1'};
rfch = rfchain(g,nf,o3, 'Name', nm);
```

Change the noise figure of 'filt1' to 20 dB.

```
setstage(rfch,2, 'NoiseFigure', 20)
```

View results on a worksheet.

```
worksheet(rfch)
```

	amp1	filt1
Stage Gain	11	-3
Stage Noise Figure	25	20
Stage OIP3	30	Inf
Stage IIP3	19	Inf
Cascaded Gain	11	8
Cascaded Noise Figure	25	25.1067
Cascaded OIP3	30	27
Cascaded IIP3	19	19

See Also

addstage | cumnoisefig | cumoip3 | worksheet | plot | cumgain | cumiip3

cumgain

Class: rfchain

Cascaded gain of the RF chain object

Syntax

```
g = cumgain(obj)
```

Description

`g = cumgain(obj)` returns the cascaded gain for each stage of the RF chain object `obj`.

Input Arguments

obj — RF chain object

scalar handle

RF chain object, specified as a scalar handle.

Output Arguments

g — Cascaded gain

vectors

Cascaded gain of the RF chain object, returned as vectors. The vector length is equal to the number of stages in the RF chain object.

Examples

Calculate Cascaded Gain

Assign stage-by-stage values of gain, noise figure, OIP3 and stage names.

```
g = [11 -3 7];  
nf = [25 3 5];  
o3 = [30 Inf 10];  
nm = {'amp1', 'filt1', 'lna1'};
```

Create an RF chain object `rfch`.

```
rfch = rfchain(g,nf,o3, 'Name',nm);
```

Calculate cascaded gain.

```
gain = cumgain(rfch)
```

```
gain =
```

```
    11     8    15
```

See Also

[addstage](#) | [worksheet](#) | [cumiiip3](#) | [setstage](#) | [plot](#) | [cumnoisefig](#) | [cumoip3](#)

cumnoisefig

Class: rfchain

Cascaded noise figure of the RF chain object

Syntax

```
nf = noisefig(obj)
```

Description

`nf = noisefig(obj)` returns the cascaded noise figure for each stage for RF chain object `obj`. The syntax first calculates the noise factor and then the noise figure. The formulae used are:

$$\text{noisefactor}(\text{total}) = \text{noisefactor}(1) + (\text{noisefactor}(2) - 1) / g_1 + (\text{noisefactor}(3) - 1) / g_1 + g_2 + \dots$$

$$\text{noisefigure} = 10 * \log_{10}(\text{noisefactor})$$

Input Arguments

obj — RF chain object

scalar handle

RF chain object, specified as a scalar handle.

Output Arguments

nf — Cascaded noise figure

vectors

Cascaded noise figure for RF chain object, returned as vectors. The vector length is equal to the number of stages in the RF chain object.

Examples

Calculate Cascaded Noise Figure

Assign stage-by-stage values of gain, noise figure, OIP3 and stage names.

```
g = [11 -3 7];  
nf = [25 3 5];  
o3 = [30 Inf 10];  
nm = {'amp1', 'filt1', 'lna1'};
```

Create an RF chain object `rfch`.

```
rfch = rfchain(g,nf,o3,'Name',nm);
```

Calculate cascaded noise figure.

```
noisefig = cumnoisefig(rfch)
```

```
noisefig =
```

```
25.0000    25.0011    25.0058
```

See Also

[addstage](#) | [worksheet](#) | [cumoip3](#) | [setstage](#) | [plot](#) | [cumgain](#) | [cumoip3](#)

cumoip3

Class: rfchain

Cascaded output-referred third-order intercept of the RF chain object

Syntax

```
oip3val = oip3(obj)
```

Description

`oip3val = oip3(obj)` returns the cascaded output-referred third-order intercept for each stage of the RF chain object `obj`. The `oip3` is calculated using the formula:

$$oip3lin = iip3lin * gainlin$$

where all values are linear

Input Arguments

obj — RF chain object

scalar handle

RF chain object, specified as a scalar handle.

Output Arguments

oip3val — Cascaded output-referred third-order intercept

vectors

Cascaded output-referred third-order intercept for RF chain object, returned as vectors. The vector length is equal to the number of stages in the RF chain object.

Examples

Calculate Cascaded OIP3

Assign stage-by-stage values of gain, noise figure, OIP3 and stage names.

```
g = [11 -3 7];  
nf = [25 3 5];  
o3 = [30 Inf 10];  
nm = {'amp1', 'filt1', 'lna1'};
```

Create an RF chain object `rfch`.

```
rfch = rfchain(g,nf,o3,'Name',nm);
```

Calculate cascaded OIP3.

```
oip3val = cumoip3(rfch)
```

```
oip3val =
```

```
30.0000  27.0000  9.9827
```

See Also

`addstage` | `worksheet` | `cumgain` | `setstage` | `plot` | `cumnoisefig` | `cumiip3`

cumiip3

Class: rfchain

Cascaded input-referred third-order intercept of the RF chain object

Syntax

```
ip3val = iip3(obj)
```

Description

`ip3val = iip3(obj)` returns the cascaded input-referred third-order intercept for each stage of the RF chain object `obj`. The input-referred third-order intercept is calculated using the formula:

$$1 / iip3lin(total) = 1 / iip3lin(1) + g1 / iip3lin(2) + (g1 * g2) / iiplin(3) + \dots$$

where, $iip3lin = iip3$ (linear values)

Input Arguments

obj — RF chain object
scalar handle

RF chain object, specified as a scalar handle.

Output Arguments

ip3va1 — Cascaded input-referred third-order intercept
vectors

Cascaded input-referred third-order intercept for RF chain object, returned as vectors. The vector length is equal to the number of stages in the RF chain object.

Examples

Calculate Cascaded IIP3

Assign stage-by-stage values of gain, noise figure, IIP3 and stage names.

```
g = [11 -3 7];  
nf = [25 3 5];  
i3 = [19 Inf 3];  
nm = {'amp1', 'filt1', 'lna1'};
```

Create an RF chain object rfch.

```
rfch = rfchain(g,nf,'IIP3',i3,'Name',nm);
```

Calculate cascaded IIP3.

```
iip3val = cumiip3(rfch)
```

```
iip3val =
```

```
19.0000 19.0000 -5.0173
```

See Also

[addstage](#) | [rfchain](#) | [cumnoisefig](#) | [cumoip3](#) | [worksheet](#) | [plot](#) | [cumgain](#) | [setstage](#)

plot

Class: rfchain

Plot RF chain cascaded analysis results.

Syntax

```
plot(obj)
```

```
h = plot(obj)
```

Description

`plot(obj)` displays a plot of the cascaded gain, noise figure, OIP3 and IIP3 values of the RF chain object `obj`.

`h = plot(obj)` returns a column vector of line series handles, where `h` contains one handle per plotted line.

Input Arguments

obj — RF chain object

scalar handle

RF chain object, specified as a scalar handle.

Output Arguments

h — line series handle

column vector

Line series handle, returned as a column vector, that contains one handle per plotted line.

Examples

Plot Results of RF Chain Object

Assign stage-by-stage values of gain, noise figure, OIP3 and stage names.

```
g = [11 -3 7];  
nf = [25 3 5];  
oip3 = [30 Inf 10];  
nm = {'amp1', 'filt1', 'lna1'};
```

Create an RF chain object rfch.

```
rfch = rfchain(g,nf,oip3,'Name',nm);
```

Plot the results.

```
plot(rfch)
```

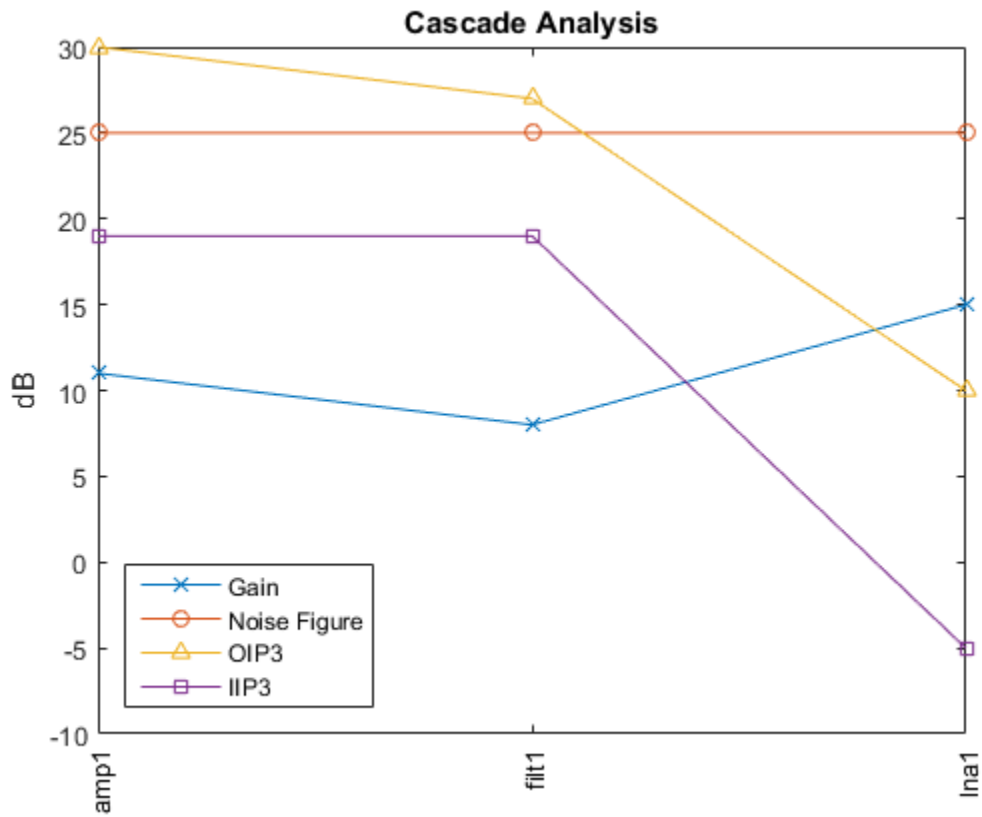

See Also

[addstage](#) | [cumnoisefig](#) | [cumoip3](#) | [worksheet](#) | [cumgain](#) | [setstage](#) | [cumiip3](#)

worksheet

Class: rfchain

RF chain cascaded analysis table

Syntax

```
worksheet(obj)
```

```
fig = worksheet(obj)
```

Description

`worksheet(obj)` displays a table of values for the gain, noise figure, OIP₃, and IIP₃ of the RF chain object `obj`. The table contains both the original input values and the calculated cascade values.

`fig = worksheet(obj)` returns a figure handle of the table.

Input Arguments

obj — RF chain object
scalar handle

RF chain object, specified as a scalar handle.

Output Arguments

fig — figure handle
scalar handle object

Figure handle of the table, returned as a scalar handle object, that contains the properties of the RF chain object.

Examples

View Results Of RF Chain Object In Worksheet

Assign stage-by-stage values of gain, noise figure, OIP3 and stage names.

```
g = [11 -3 7];
nf = [25 3 5];
oip3 = [30 Inf 10];
nm = {'amp1', 'filt1', 'lna1'};
```

Create an RF chain object `rfch`.

```
rfch = rfchain(g,nf,oip3,'Name',nm);
```

View the results in a worksheet.

```
worksheet(rfch)
```

	amp1	filt1	lna1
Stage Gain	11	-3	7
Stage Noise Figure	25	3	5
Stage OIP3	30	Inf	10
Stage IIP3	19	Inf	3
Cascaded Gain	11	8	15
Cascaded Noise Figure	25	25.0011	25.0058
Cascaded OIP3	30	27	9.9827
Cascaded IIP3	19	19	-5.0173

See Also

`addstage` | `cumnoisefig` | `cumoip3` | `setstage` | `plot` | `cumgain` | `cumiip3`

groupdelay

Group delay of s-parameter object or RF Toolbox network object

Syntax

```
gd = groupdelay(sparamobj)
gd = groupdelay(rfobj, freq)
gd = groupdelay(__, i, j)
gd = groupdelay(__, Name, Value)
```

Description

`gd = groupdelay(sparamobj)` calculates the group delay of an S-parameter object at the frequencies specified in the S-parameter object file. `sparamobj` can be an s-parameters object or a nport object.

`gd = groupdelay(rfobj, freq)` calculates the group delay of an RF Toolbox network object, `rfobj`, at specified frequencies.

`gd = groupdelay(__, i, j)` calculates the group delay of a specific S_{ij} . If `i, j` are not specified, the group delay is calculated for S_{21} for two-port objects and S_{11} for non-two-port objects.

`gd = groupdelay(__, Name, Value)` calculates the group delay using additional options specified by one or more `Name, Value` pair arguments. You can use any of the arguments from previous syntaxes.

Examples

Group Delay of RLC Notch Filter

Calculate and plot the group delay of an RLC notch filter at a frequency range from 10 GHz through 1000 GHz frequency.

```
filt = circuit('notch');
```

```
add(filt,[1 2],resistor(200))
add(filt,[1 2],inductor(100e-9))
add(filt,[1 2],capacitor(25e-12))
setports(filt,[1 0],[2 0])
freq = 10e6:10e4:1000e6;
gd1 = groupdelay(filt,freq);
figure
plot(freq,gd1)
```

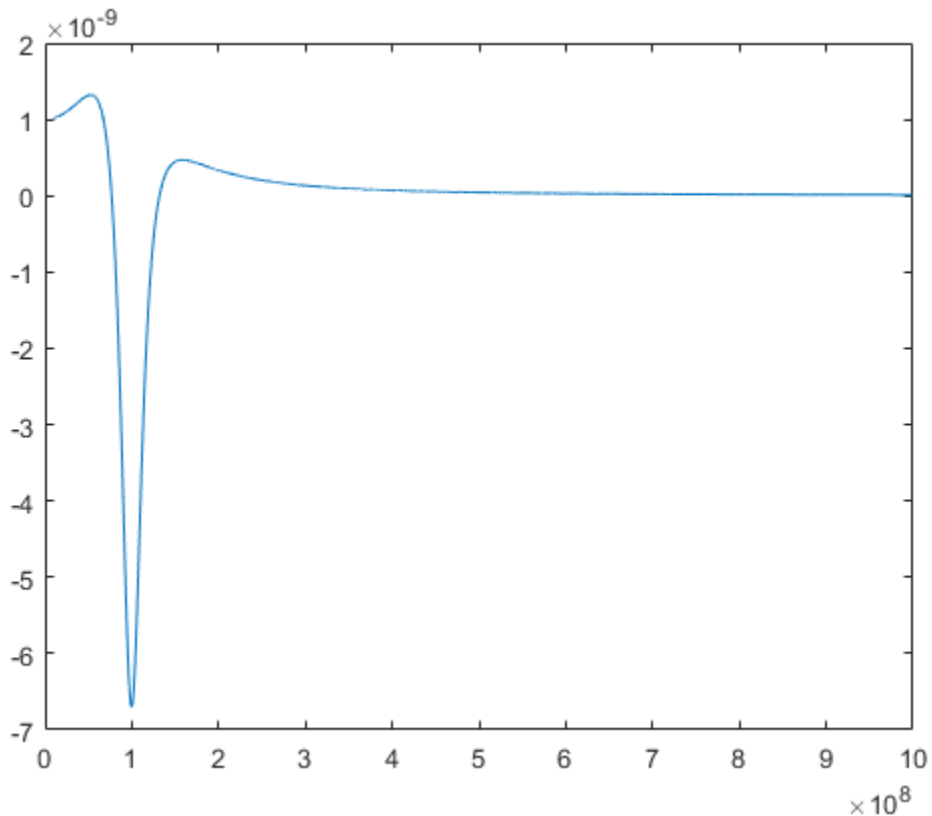

Group Delay of S-Parameter Data File.

Find and plot the group delay of the file 'defaultbandpass.s2p'.

```
S = sparameters('defaultbandpass.s2p');
freq = S.Frequencies;
```

```
gd2 = groupdelay(S,freq);  
figure  
plot(freq,gd2)
```

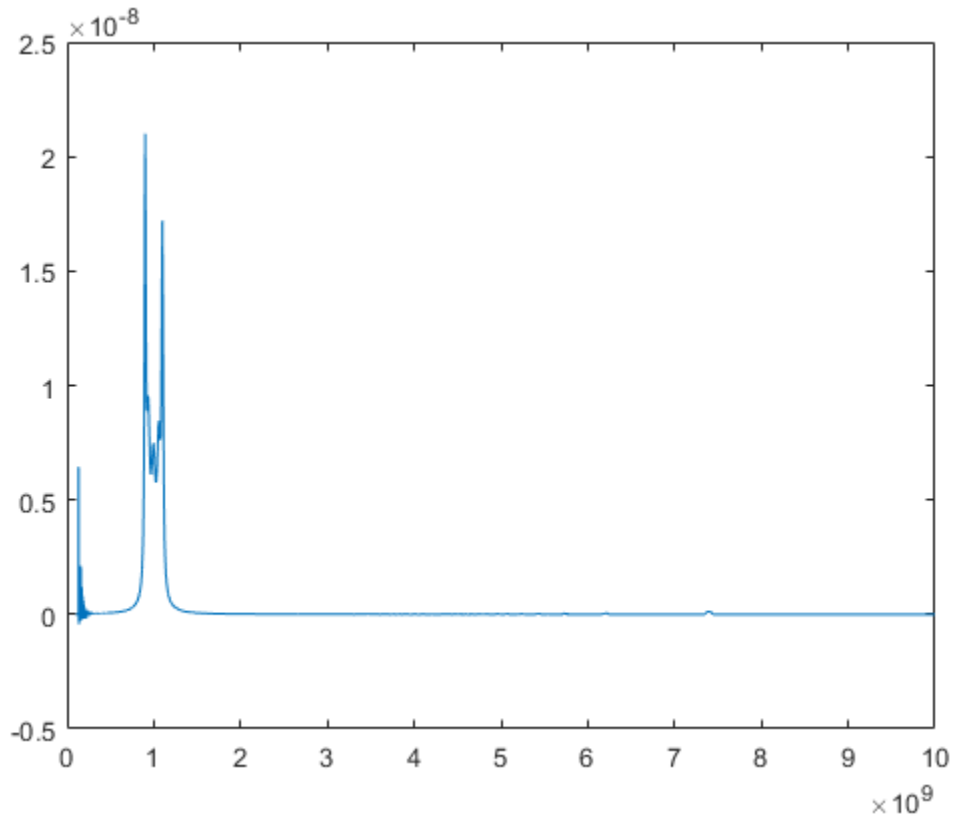

Input Arguments

sparamobj — S-parameter Touchstone data file

string

S-parameter Touchstone data file, specified as string. The function uses the data in this file to calculate the group delay.

Example: 'defaultbandpass.s2p'

rfobj — RF network object

object

RF network object, specified as object, of the following types: s-parameters, nport, circuit, and lcladder.

Example: lcladder

freq — Frequencies

vector of positive real numbers for rf objects

Frequencies, specified as a vector of positive real numbers.

i, j — Port numbers of s-parameter object or rf object

scalar integers

Port numbers of s-parameter object or rf object, specified as a scalar integer.

Example: S12

Name-Value Pair Arguments

Example: `gd = groupdelay (filter, frequency, 'Aperture', 50)`

Optional comma-separated pairs of **Name**, **Value** arguments, where **Name** is the argument name and **Value** is the corresponding value. **Name** must appear inside single quotes (' ').

'Aperture' — Width of two frequency points

`freq*sqrt(eps)` (default) | real, positive, numeric scalar or vector

Width of two frequency points, specified as the comma-separated pair consisting of 'Aperture' and a real, positive, numerics scalar or vector.

Example: 'Aperture', 50

Data Types: double

'Impedance' — Impedance of S-parameters

real, positive, scalar

Impedance of S-parameters, specified as the comma-separated pair consisting of 'Impedance' and a real positive numeric scalar. The default impedance values for different objects are:

- 50 — LC ladder and circuit objects
- `obj.impedance` — S-parameter objects
- `obj.networkdata.impedance` — N-port objects

Example: 50

Data Types: `double`

Output Arguments

gd — Group delay

numeric scalar in seconds

Group delay, returned as a numeric scalar in seconds.

See Also

`nport` | `lcladder` | `sparameters`

Introduced in R2015b

Functions — Alphabetical List

abcd2h

Convert ABCD-parameters to hybrid h-parameters

Syntax

```
h_params = abcd2h(abcd_params)
```

Description

`h_params = abcd2h(abcd_params)` converts the ABCD-parameters `abcd_params` into the hybrid parameters `h_params`. The `abcd_params` input is a complex 2-by-2-by- M array, representing M 2-port ABCD-parameters. `h_params` is a complex 2-by-2-by- M array, representing M 2-port hybrid h-parameters.

Alternatives

You can also use network parameter objects to perform network parameter conversions. For more information, see “RF Network Parameter Objects” on page 2-11.

Examples

Convert ABCD-parameters to h-parameters:

```
%Define a matrix of ABCD-parameters.  
A =      0.999884396265344 + 0.000129274757618717i;  
B =      0.314079483671772 +      2.51935878310427i;  
C = -6.56176712108866e-007 + 6.67455405306704e-006i;  
D =      0.999806365547959 + 0.000247230611054075i;  
abcd_params = [A,B; C,D];  
%Convert to h-parameters  
h_params = abcd2h(abcd_params);
```

See Also

abcd2s | abcd2y | abcd2z | h2abcd | s2h | y2h | z2h

abcd2s

Convert ABCD-parameters to S-parameters

Syntax

```
s_params = abcd2s(abcd_params,z0)
```

Description

`s_params = abcd2s(abcd_params,z0)` converts the ABCD-parameters `abcd_params` into the scattering parameters `s_params`. The `abcd_params` input is a complex $2N$ -by- $2N$ -by- M array, representing M $2N$ -port ABCD-parameters. `z0` is the reference impedance; its default is 50 ohms. The function assumes that the ABCD-parameter matrices have distinct A , B , C , and D submatrices:

$$\begin{bmatrix} [A] & [B] \\ [C] & [D] \end{bmatrix}$$

`s_params` is a complex $2N$ -by- $2N$ -by- M array, representing M $2N$ -port S-parameters.

Alternatives

You can also use network parameter objects to perform network parameter conversions. For more information, see “RF Network Parameter Objects” on page 2-11.

Examples

Convert ABCD-parameters to S-parameters:

```
%Define a matrix of ABCD-parameters.
A =      0.999884396265344 + 0.000129274757618717i;
B =      0.314079483671772 +      2.51935878310427i;
C = -6.56176712108866e-007 + 6.67455405306704e-006i;
```

```
D =      0.999806365547959 + 0.000247230611054075i;  
abcd_params = [A,B; C,D];  
%Convert to S-parameters  
s_params = abcd2s(abcd_params);
```

See Also

abcd2h | abcd2y | abcd2z | s2abcd | s2h | y2h | z2h

abcd2y

Convert ABCD-parameters to Y-parameters

Syntax

```
y_params = abcd2y(abcd_params)
```

Description

`y_params = abcd2y(abcd_params)` converts the ABCD-parameters `abcd_params` into the admittance parameters `y_params`. The `abcd_params` input is a complex $2N$ -by- $2N$ -by- M array, representing M $2N$ -port ABCD-parameters. The function assumes that the ABCD-parameter matrices have distinct A , B , C , and D submatrices:

$$\begin{bmatrix} [A] & [B] \\ [C] & [D] \end{bmatrix}$$

`y_params` is a complex $2N$ -by- $2N$ -by- M array, representing M $2N$ -port Y-parameters.

Alternatives

You can also use network parameter objects to perform network parameter conversions. For more information, see “RF Network Parameter Objects” on page 2-11.

Examples

Convert ABCD-parameters to Y-parameters:

```
%Define a matrix of ABCD-parameters.
A =      0.999884396265344 + 0.000129274757618717i;
B =      0.314079483671772 +      2.51935878310427i;
C = -6.56176712108866e-007 + 6.67455405306704e-006i;
D =      0.999806365547959 + 0.000247230611054075i;
```

```
abcd_params = [A,B; C,D];  
%Convert to Y-parameters  
y_params = abcd2y(abcd_params);
```

See Also

abcd2h | abcd2s | abcd2z | h2y | s2y | y2abcd | z2y

abcd2z

Convert ABCD-parameters to Z-parameters

Syntax

```
z_params = abcd2z(abcd_params)
```

Description

`z_params = abcd2z(abcd_params)` converts the ABCD-parameters `abcd_params` into the impedance parameters `z_params`. The `abcd_params` input is a complex $2N$ -by- $2N$ -by- M array, representing M $2N$ -port ABCD-parameters. The function assumes that the ABCD-parameter matrices have distinct A , B , C , and D submatrices:

$$\begin{bmatrix} [A] & [B] \\ [C] & [D] \end{bmatrix}$$

`z_params` is a complex $2N$ -by- $2N$ -by- M array, representing M $2N$ -port Z-parameters.

Alternatives

You can also use network parameter objects to perform network parameter conversions. For more information, see “RF Network Parameter Objects” on page 2-11.

Examples

Convert ABCD-parameters to Z-parameters:

```
%Define a matrix of ABCD-parameters.
A = 0.999884396265344 + 0.000129274757618717i;
B = 0.314079483671772 + 2.51935878310427i;
C = -6.56176712108866e-007 + 6.67455405306704e-006i;
D = 0.999806365547959 + 0.000247230611054075i;
```

```
abcd_params = [A,B; C,D];  
%Convert to Z-parameters  
z_params = abcd2z(abcd_params);
```

See Also

abcd2h | abcd2s | abcd2y | h2y | y2abcd | z2abcd

cascadesparams

Combine S-parameters to form cascaded network

Syntax

```
s_params = cascadesparams(s1_params, s2_params, ..., sk_params)
hs = cascadesparams(hs1, hs2, ..., hsk)
s_params = cascadesparams(s1_params, s2_params, ..., sk_params, Kconn)
```

Description

`s_params = cascadesparams(s1_params, s2_params, ..., sk_params)` cascades the scattering parameters of the K input networks described by the S-parameters `s1_params` through `sk_params`. The function stores the S-parameters of the cascade in `s_params`. Each of the input networks must be a $2N$ -port network described by a $2N$ -by- $2N$ -by- M array of S-parameters. All networks must have the same reference impedance.

`hs = cascadesparams(hs1, hs2, ..., hsk)` cascades K S-parameter objects to create the cascaded network `hs`. The function checks that the **Impedance** and **Frequencies** properties of each object are equal and that the **Parameters** property contains a $2N$ -by- $2N$ -by- M array of S-parameters.

`cascadesparams` assumes that you are using the port ordering given in the following illustration.

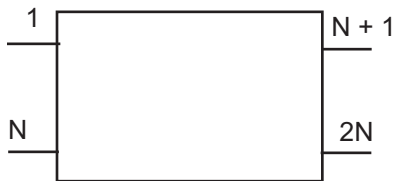

Based on this ordering, the function connects ports $N + 1$ through $2N$ of the first network to ports 1 through N of the second network. Therefore, when you use this syntax:

- Each network has an even number of ports
- Every network in the cascade has the same number of ports.

To use this function for S-parameters with different port arrangements, use the `snp2smp` function to reorder the port indices before cascading the networks.

`s_params = cascadesparams(s1_params, s2_params, ..., sk_params, Kconn)`
cascades the scattering parameters of the K input networks described by the S-parameters `s1_params` through `sk_params`. The function creates a cascaded network based on the number of cascade connections between networks, specified by `Kconn`. `Kconn` must be a positive scalar or vector of size $K - 1$.

- If `Kconn` is a scalar, `cascadesparams` makes the same number of connections between each pair of consecutive networks.
- If `Kconn` is a vector, the i th element of `Kconn` specifies the number of connections between the i th and the $i+1$ th networks.

`cascadesparams` always connects the last `Kconn(i)` ports of the i th network and the first `Kconn(i)` ports of the $i+1$ th network. The ports of the entire cascaded network represent the unconnected ports of each individual network, taken in order from the first network to the n th network.

Also, when you specify `Kconn`:

- Each network can have either an even or odd number of ports.
- Every network in the cascade can have a different number of ports.

Examples

Assemble a 2-port cascaded network from two sets of 2-port S-parameters:

```
%Create two sets of 2-port S-parameters
ckt1 = read(rfckt.amplifier, 'default.s2p');
ckt2 = read(rfckt.passive, 'passive.s2p');
freq = [2e9 2.1e9];
analyze(ckt1, freq);
analyze(ckt2, freq);
sparams_2p_1 = ckt1.AnalyzedResult.S_Parameters;
sparams_2p_2 = ckt2.AnalyzedResult.S_Parameters;
%Cascade the S-parameters
sparams_cascaded_2p = ...
    cascadesparams(sparams_2p_1, sparams_2p_2)
```

Assemble a 3-port cascaded network from a set of 3-port S-parameters and a set of 2-port S-parameters:

```

% Create one set of 3-port S-parameters
% and one set of 2-port S-parameters
ckt1 = read(rfckt.passive,'default.s3p');
ckt2 = read(rfckt.amplifier,'default.s2p');
freq = [2e9 2.1e9];
analyze(ckt1,freq);
analyze(ckt2,freq);
sparams_3p = ckt1.AnalyzedResult.S_Parameters;
sparams_2p = ckt2.AnalyzedResult.S_Parameters;
%Cascade the two sets by connecting one port between them
Kconn = 1
sparams_cascaded_3p = ...
    cascadesparams(sparams_3p,sparams_2p,Kconn)

```

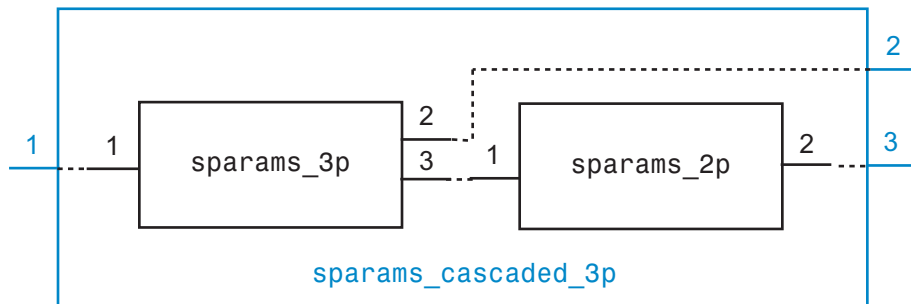

Assemble a 3-port cascaded network from a set of 3-port S-parameters and a set of 2-port S-parameters, connecting the second port of the 3-port network to the first port of the 2-port network:

```

ckt1 = read(rfckt.passive,'default.s3p');
ckt2 = read(rfckt.amplifier,'default.s2p');
freq = [2e9 2.1e9];
analyze(ckt1,freq);
analyze(ckt2,freq);
sparams_3p = ckt1.AnalyzedResult.S_Parameters;
sparams_2p = ckt2.AnalyzedResult.S_Parameters;
%Reorder the second and third ports of the 3-port network
sparams_3p_2 = snp2smp(sparams_3p,50,[1 3 2])
%Cascade the two sets by connecting one port between them
Kconn = 1
sparams_cascaded_3p_2 = cascadesparams(sparams_3p_2,...
    sparams_2p,Kconn)

```

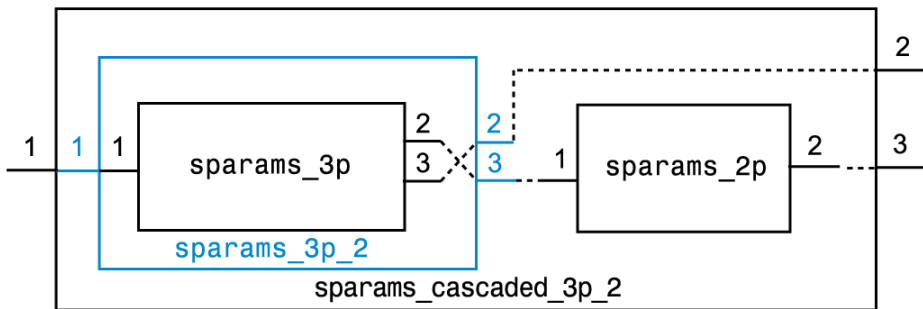

Assemble a 3-port cascaded network from a set of 3-port S-parameters and two sets of 2-port S-parameters:

```

ckt1 = read(rfckt.passive,'default.s3p');
ckt2 = read(rfckt.amplifier,'default.s2p');
ckt3 = read(rfckt.passive,'passive.s2p');
freq = [2e9 2.1e9];
analyze(ckt1,freq);
analyze(ckt2,freq);
analyze(ckt3,freq);
sparams_3p = ckt1.AnalyzedResult.S_Parameters;
sparams_2p_1 = ckt2.AnalyzedResult.S_Parameters;
sparams_2p_2 = ckt3.AnalyzedResult.S_Parameters;
%Connect one port between each set of adjacent networks
Kconn = [1 1]
sparams_cascaded_3p_3 = cascadesparams(sparams_3p,...
    sparams_2p_1,sparams_2p_2,Kconn)

```

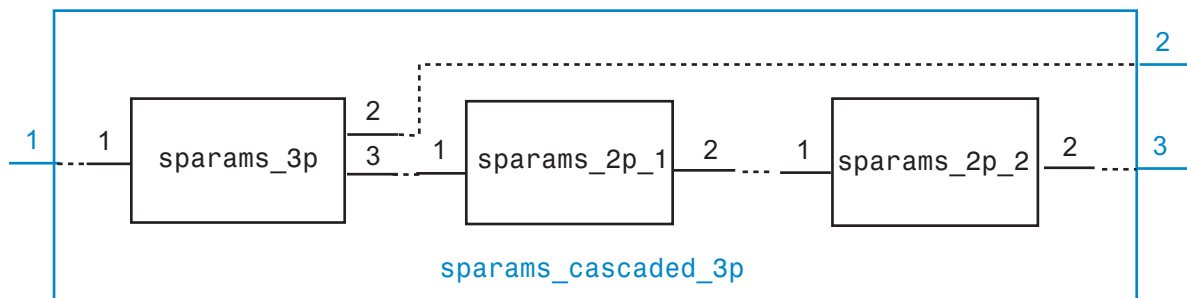

Assemble a 3-port cascaded network from a set of 3-port S-parameters and two sets of 2-port S-parameters, connecting the 3-port network to both 2-port networks:

```

ckt1 = read(rfckt.passive,'default.s3p');
ckt2 = read(rfckt.amplifier,'default.s2p');
ckt3 = read(rfckt.passive,'passive.s2p');
freq = [2e9 2.1e9];
analyze(ckt1,freq);
analyze(ckt2,freq);
analyze(ckt3,freq);
sparams_3p = ckt1.AnalyzedResult.S_Parameters;
sparams_2p_1 = ckt2.AnalyzedResult.S_Parameters;
sparams_2p_2 = ckt3.AnalyzedResult.S_Parameters;
%Cascade sparams_3p and sparams_2p_1
%by connecting one port between them
Kconn = 1
sparams_cascaded_3p = cascadesparams(...
    sparams_3p, ...
    sparams_2p_1, ...
    Kconn)
%Reorder the second and third ports of the 3-port network
sparams_cascaded_3p_3 = snp2smp(...
    sparams_cascaded_3p, ...
    50, ...
    [1 3 2])
%Cascade sparams_3p and sparams_2p_2
%by connecting one port between them
sparams_cascaded_3p_4 = cascadesparams(...
    sparams_cascaded_3p_3, ...
    sparams_2p_2, ...
    Kconn)

```

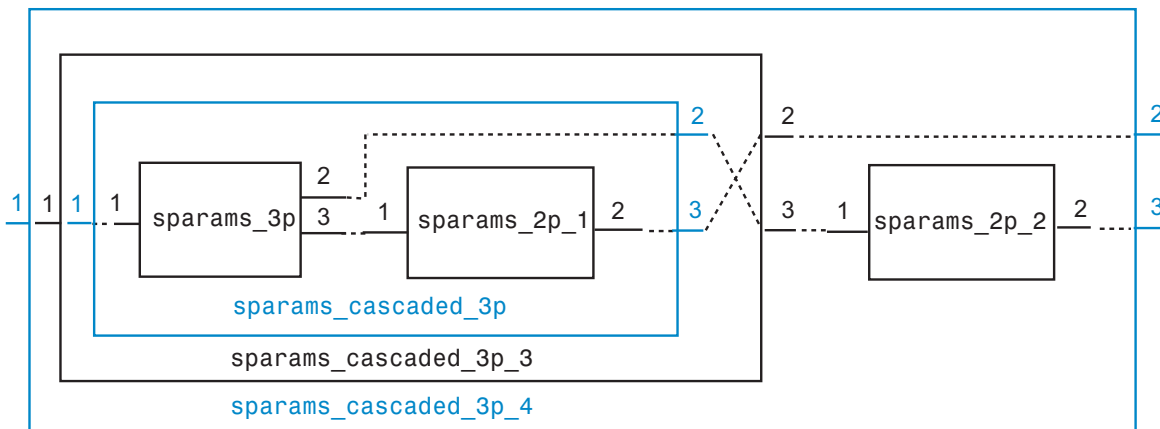

See Also

deembedsparams | rfckt.cascade | s2t | t2s | snp2smp

copy

Copy circuit or data object

Syntax

```
h2 = copy(h)
```

Description

`h2 = copy(h)` returns a copy of the circuit, data, or network parameter object `h`.

The syntax `h2 = h` copies only the object handle and does not create an object.

Alternatives

The syntax `h2 = h` copies only the object handle and does not create an object.

See Also

`analyze`

deembedsparams

De-embed 2N-port S-parameters

Syntax

```
s2_params = deembedsparams(s_params, s1_params, s3_params)
```

```
hs2 = deembedsparams(hs, hs1, hs3)
```

Description

`s2_params = deembedsparams(s_params, s1_params, s3_params)` de-embeds `s2_params` from cascaded S-parameters `s_params`, by removing the effects of `s1_params` and `s3_params`. `deembedsparams` assumes that you are using the port ordering shown here:

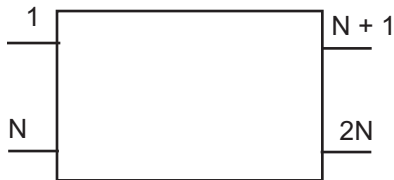

This function is ideal for situations in which the S-parameters of a [DUT](#) (device under test) must be de-embedded from S-parameters obtained through measurement.

`hs2 = deembedsparams(hs, hs1, hs3)` de-embeds S-parameter object, `hs2` from the chain `hs`.

Input Arguments

s_params, s1_params, s3_params — S-parameter data
numeric arrays

S-parameter data, specified as $2N \times 2N \times K$ arrays of K $2N$ -port S-parameters. `s_params` is the measured S-parameter array of the cascaded network. `s1_params` represents the first network of the cascade, and `s3_params` represents the third network. The function assumes that all networks in the cascade have the same reference impedance and are measured at the same frequencies. The function assumes the configuration of the cascade shown here:

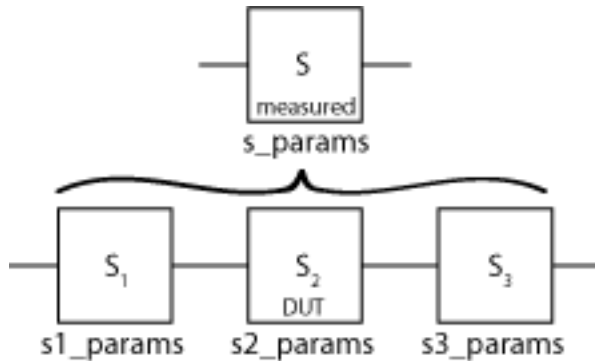

Data Types: double
Complex Number Support: Yes

hs, hs1, hs3 — S-parameter objects
scalar handle objects

S-parameter objects, specified as $2N$ -port scalar handle objects, which can include numeric arrays of S-parameters. The function checks that the `Frequencies` and `Impedance` properties are the same for all three inputs.

Data Types: function_handle

Output Arguments

s2_params — S-parameter data
numeric arrays

S-parameter data, returned as $2N \times 2N \times K$ arrays of K $2N$ -port s-parameters, containing de-embedded S-parameters of the DUT (device under test).

Data Types: double
Complex Number Support: Yes

hs2 — S-parameter objects

scalar handle object

S-parameter objects, returned as 2N-port scalar handle objects, containing de-embedded S-parameter objects of DUT (device under test).

Data Types: `function_handle`

Examples

De-embed S-Parameters of a DUT from a Cascaded 2-port Network

Read measured S-parameters of the cascaded network from `samplebjt2.s2p`.

```
S_measuredBJT = sparameters('cascadedbackplanes.s4p');  
freq = S_measuredBJT.Frequencies;
```

Calculate the S-parameters of the left fixture of the network.

```
leftpad = circuit('left');  
add(leftpad,[1 2],inductor(1e-9))  
add(leftpad,[2 3],capacitor(100e-15))  
setports(leftpad,[1 0],[3 0],[2 0],[3 0])  
S_leftpad = sparameters(leftpad,freq)
```

```
S_leftpad =
```

```
  sparameters: S-parameters object
```

```
    NumPorts: 4
```

```
    Frequencies: [1496x1 double]
```

```
    Parameters: [4x4x1496 double]
```

```
    Impedance: 50
```

```
  rfparam(obj,i,j) returns S-parameter Sij
```

Calculate the S-parameters of the right fixture of the network.

```
rightpad = circuit('right');  
add(rightpad,[1 3],capacitor(100e-15))  
add(rightpad,[1 2],inductor(1e-9))  
setports(rightpad,[1 0],[3 0],[2 0],[3 0])
```



```
S_rightpad = sparameters(rightpad,freq)
```

```
S_rightpad =
```

```
  sparameters: S-parameters object
```

```
    NumPorts: 4  
  Frequencies: [1496x1 double]  
  Parameters: [4x4x1496 double]  
  Impedance: 50
```

```
  rfparam(obj,i,j) returns S-parameter Sij
```

De-embed the S-parameters of the DUT. The output is stored in S-DUT in MATLAB workspace.

```
S_DUT = deembedsparams(S_measuredBJT,S_leftpad,S_rightpad)
```

```
S_DUT =
```

```
  sparameters: S-parameters object
```

```
    NumPorts: 4  
  Frequencies: [1496x1 double]  
  Parameters: [4x4x1496 double]  
  Impedance: 50
```

```
  rfparam(obj,i,j) returns S-parameter Sij
```

For a more detailed example on how to use deembedsparams, see the RF Toolbox example De-Embedding S-Parameters.

De-embed S-Parameters of a DUT from a Cascaded 4-port Network

Read measured S-parameters of the cascaded network from `cascadedbackplanes.s4p`

```
S_measuredBJT = sparameters('cascadedbackplanes.s4p');  
freq = S_measuredBJT.Frequencies;
```

Calculate the S-parameters of the left fixture of the network.

```
leftpad = circuit('left');
```

```
add(leftpad,[1 2],inductor(1e-9))
add(leftpad,[2 3],capacitor(100e-15))
setports(leftpad,[1 0],[3 0],[2 0],[3 0])
S_leftpad = sparameters(leftpad,freq)
```

```
S_leftpad =
```

```
  sparameters: S-parameters object
```

```
    NumPorts: 4
  Frequencies: [1496x1 double]
  Parameters: [4x4x1496 double]
  Impedance: 50
```

```
  rfparam(obj,i,j) returns S-parameter Sij
```

Calculate the S-parameters of the right fixture of the network.

```
rightpad = circuit('right');
add(rightpad,[1 3],capacitor(100e-15))
add(rightpad,[1 2],inductor(1e-9))
setports(rightpad,[1 0],[3 0],[2 0],[3 0])
S_rightpad = sparameters(rightpad,freq)
```

```
S_rightpad =
```

```
  sparameters: S-parameters object
```

```
    NumPorts: 4
  Frequencies: [1496x1 double]
  Parameters: [4x4x1496 double]
  Impedance: 50
```

```
  rfparam(obj,i,j) returns S-parameter Sij
```

De-embed the S-parameters of the DUT. The output is stored in S-DUT in MATLAB workspace.

```
S_DUT = deembedsparams(S_measuredBJT,S_leftpad,S_rightpad)
```

S_DUT =

sparameters: S-parameters object

NumPorts: 4

Frequencies: [1496x1 double]

Parameters: [4x4x1496 double]

Impedance: 50

rfparam(obj,i,j) returns S-parameter S_{ij}

See Also

[cascadesparams](#) | [rfckt.cascade](#)

g2h

Convert hybrid g-parameters to hybrid h-parameters

Syntax

```
h_params = g2h(g_params)
```

Description

`h_params = g2h(g_params)` converts the hybrid g-parameters, `g_params`, into the hybrid h-parameters, `h_params`. The `g_params` input is a complex 2-by-2-by- M array, representing M 2-port g-parameters. `h_params` is a complex 2-by-2-by- M array, representing M 2-port h-parameters.

Alternatives

You can also use network parameter objects to perform network parameter conversions. For more information, see “RF Network Parameter Objects” on page 2-11.

Examples

Convert g-parameters to h-parameters:

```
%Define a matrix of g-parameters.  
g_11 = -6.55389515512306e-007 + 6.67541048071651e-006i;  
g_12 = -0.999823389146385 - 0.000246785162909241i;  
g_21 = 1.00011560038266 - 0.000129304649930592i;  
g_22 = 0.314441556185771 + 2.51960941000598i;  
g_params = [g_11,g_12; g_21,g_22];  
%Convert to h-parameters  
h_params = g2h(g_params);
```

See Also

h2g

gamma2z

Convert reflection coefficient to impedance

Syntax

```
z = gamma2z(gamma)
z = gamma2z(gamma, z0)
```

Description

`z = gamma2z(gamma)` converts the reflection coefficient `gamma` to the impedance `z` using a reference impedance Z_0 of 50 ohms.

`z = gamma2z(gamma, z0)` converts the reflection coefficient `gamma` to the impedance `z` by:

- Computing the normalized impedance.
- Multiplying the normalized impedance by the reference impedance Z_0 .

Examples

Calculate impedance from given reference impedance and reflection coefficient values:

```
z0 = 50;
gamma = 1/3;
z = gamma2z(gamma, z0)
```

More About

Algorithms

The following equation shows this conversion:

$$Z = Z_0 * \left(\frac{1 + \Gamma}{1 - \Gamma} \right)$$

See Also

gammain | gammaout | z2gamma

gammain

Input reflection coefficient of 2-port network

Syntax

```
coefficient = gammain(s_params,z0,z1)  
coefficient = gammain(hs,z1)
```

Description

`coefficient = gammain(s_params,z0,z1)` calculates the input reflection coefficient of a 2-port network. `s_params` is a complex 2-by-2-by- M array, representing M 2-port S-parameters. `z0` is the reference impedance Z_0 ; its default value is 50 ohms. `z1` is the load impedance Z_L ; its default value is also 50 ohms. `coefficient` is an M -element complex vector.

`coefficient = gammain(hs,z1)` calculates the input reflection coefficient of the 2-port network represented by the S-parameter object `hs`.

Examples

Calculate the input reflection coefficients at each index of an S-parameter array:

```
ckt = read(rfckt.amplifier,'default.s2p');  
s_params = ckt.NetworkData.Data;  
z0 = ckt.NetworkData.Z0;  
z1 = 100;  
coefficient = gammain(s_params,z0,z1);
```

More About

Algorithms

`gammain` uses the formula

$$\Gamma_{in} = S_{11} + \frac{(S_{12}S_{21})\Gamma_L}{1 - S_{22}\Gamma_L}$$

where

$$\Gamma_L = \frac{Z_l - Z_0}{Z_l + Z_0}$$

See Also

gamma2z | gammam1 | gammams | gammaout | vswr

gammaml

Load reflection coefficient of 2-port network

Syntax

```
coefficient = gammaml(s_params)
coefficient = gammaml(hs)
```

Description

`coefficient = gammaml(s_params)` calculates the load reflection coefficient of a 2-port network required for simultaneous conjugate match.

`s_params` is a complex 2-by-2-by- M array, representing M 2-port S-parameters, S_{ij} . `coefficient` is an M -element complex vector.

`coefficient = gammaml(hs)` calculates the load reflection coefficient of the 2-port network represented by the S-parameter object `hs`.

Examples

Calculate the load reflection coefficient using network data from a file:

```
ckt = read(rfckt.amplifier, 'default.s2p');
s_params = ckt.NetworkData.Data;
coefficient = gammaml(s_params);
```

More About

Algorithms

The function calculates `coefficient` using the equation

$$\Gamma_{ML} = \frac{B_2 \pm \sqrt{B_2^2 - 4|C_2|^2}}{2C_2}$$

where

$$B_2 = 1 - |S_{11}|^2 + |S_{22}|^2 - |\Delta|^2$$

$$C_2 = S_{22} - \Delta \cdot S_{11}^*$$

$$\Delta = S_{11}S_{22} - S_{12}S_{21}$$

See Also

gammain | gammams | gammaout | stabilityk

gammams

Source reflection coefficient of 2-port network

Syntax

```
coefficient = gammams(s_params)
coefficient = gammams(hs)
```

Description

`coefficient = gammams(s_params)` calculates the source reflection coefficient of a 2-port network required for simultaneous conjugate match. `s_params` is a complex 2-by-2-by- M array, representing M 2-port S-parameters. `coefficient` is an M -element complex vector.

`coefficient = gammams(hs)` calculates the source reflection coefficient of the 2-port network represented by the S-parameter object `hs`.

Examples

Calculate the source reflection coefficient using network data from a file:

```
ckt = read(rfckt.amplifier, 'default.s2p');
s_params = ckt.NetworkData.Data;
coefficient = gammams(s_params);
```

More About

Algorithms

The function calculates `coefficient` using the equation

$$\Gamma_{MS} = \frac{B_1 \pm \sqrt{B_1^2 - 4|C_1|^2}}{2C_1}$$

where

$$B_1 = 1 + |S_{11}|^2 - |S_{22}|^2 - |\Delta|^2$$

$$C_1 = S_{11} - \Delta \cdot S_{22}^*$$

$$\Delta = S_{11}S_{22} - S_{12}S_{21}$$

See Also

gammain | gammaml | gammaout | stabilityk

gammaout

Output reflection coefficient of 2-port network

Syntax

```
coefficient = gammaout(s_params,z0,zs)  
coefficient = gammaout(hs,zs)
```

Description

`coefficient = gammaout(s_params,z0,zs)` calculates the output reflection coefficient of a 2-port network.

`s_params` is a complex 2-by-2-by- M array, representing M 2-port S-parameters. `z0` is the reference impedance Z_0 ; its default is 50 ohms. `zs` is the source impedance Z_s ; its default is also 50 ohms. `coefficient` is an M -element complex vector.

`coefficient = gammaout(hs,zs)` calculates the output reflection coefficient of the 2-port network represented by the S-parameter object `hs`.

Examples

Calculate the output reflection coefficient using network data from a file:

```
ckt = read(rfckt.amplifier,'default.s2p');  
s_params = ckt.NetworkData.Data;  
z0 = ckt.NetworkData.Z0;  
zs = 100;  
coefficient = gammaout(s_params,z0,zs);
```

More About

Algorithms

The function calculates `coefficient` using the equation

$$\Gamma_{out} = S_{22} + \frac{S_{12}S_{21}\Gamma_S}{1 - S_{11}\Gamma_S}$$

where

$$\Gamma_S = \frac{Z_s - Z_0}{Z_s + Z_0}$$

See Also

[gamma2z](#) | [gammain](#) | [gammam1](#) | [gammams](#) | [vswr](#)

getdata

Data object containing analyzed result of specified circuit object

Syntax

```
hd = getdata(h)
```

Description

`hd = getdata(h)` returns a handle, `hd`, to the `rfdata.data` object containing the analysis data, if any, for circuit (`rfckt`) object `h`. If there is no analysis data, `getdata` displays an error message.

Note: Before calling `getdata`, use the `analyze` function to perform a frequency domain analysis for the circuit (`rfckt`) object. Perform this action for all circuit objects except `rfckt.amplifier`, `rfckt.datafile`, and `rfckt.mixer`. When you create an `rfckt.amplifier`, `rfckt.datafile`, or `rfckt.mixer` object by reading data from a file, RF Toolbox software automatically creates an `rfdata.data` object. RF Toolbox stores data from the file as properties of the data object. You can use the `getdata` function, without first calling `analyze`, to retrieve the handle of the `rfdata.data` object.

h2abcd

Convert hybrid h-parameters to ABCD-parameters

Syntax

```
abcd_params = h2abcd(h_params)
```

Description

`abcd_params = h2abcd(h_params)` converts the hybrid parameters `h_params` into the ABCD-parameters `abcd_params`. The `h_params` input is a complex 2-by-2-by- M array, representing M 2-port hybrid h-parameters. `abcd_params` is a complex 2-by-2-by- M array, representing M 2-port ABCD-parameters.

Alternatives

You can also use network parameter objects to perform network parameter conversions. For more information, see “RF Network Parameter Objects” on page 2-11.

Examples

Convert h-parameters to ABCD-parameters:

```
%Define a matrix of h-parameters.  
h_11 = 0.314441556185771 + 2.51960941000598i;  
h_12 = 0.999823389146385 - 0.000246785162909241i;  
h_21 = -1.000115600382660 - 0.000129304649930592i;  
h_22 = -6.55389515512306e-007 + 6.67541048071651e-006i;  
h_params = [h_11,h_12; h_21,h_22];  
%Convert to ABCD-parameters  
abcd_params = h2abcd(h_params);
```

See Also

`abcd2h` | `h2s` | `h2y` | `h2z` | `s2abcd` | `y2abcd` | `z2abcd`

h2g

Convert hybrid h-parameters to hybrid g-parameters

Syntax

```
g_params = h2g(h_params)
```

Description

`g_params = h2g(h_params)` converts the hybrid parameters `h_params` into the hybrid g-parameters `g_params`. The `h_params` input is a complex 2-by-2-by- M array, representing M 2-port h-parameters. `g_params` is a complex 2-by-2-by- M array, representing M 2-port g-parameters.

Alternatives

You can also use network parameter objects to perform network parameter conversions. For more information, see “RF Network Parameter Objects” on page 2-11.

Examples

Convert h-parameters to g-parameters:

```
%Define a matrix of h-parameters.  
h_11 = 0.314441556185771 + 2.51960941000598i;  
h_12 = 0.999823389146385 - 0.000246785162909241i;  
h_21 = -1.000115600382660 - 0.000129304649930592i;  
h_22 = -6.55389515512306e-007 + 6.67541048071651e-006i;  
h_params = [h_11,h_12; h_21,h_22];  
%Convert to g-parameters  
g_params = h2g(h_params);
```

See Also

g2h | h2abcd | h2s | h2y | h2z

h2s

Convert hybrid h-parameters to S-parameters

Syntax

```
s_params = h2s(h_params,z0)
```

Description

`s_params = h2s(h_params,z0)` converts the hybrid parameters `h_params` into the scattering parameters `s_params`. The `h_params` input is a complex 2-by-2-by- M array, representing M 2-port hybrid h-parameters. `z0` is the reference impedance; its default is 50 ohms. `s_params` is a complex 2-by-2-by- M array, representing M 2-port S-parameters.

Alternatives

You can also use network parameter objects to perform network parameter conversions. For more information, see “RF Network Parameter Objects” on page 2-11.

Examples

Convert h-parameters to S-parameters:

```
%Define a matrix of h-parameters.  
h_11 = 0.314441556185771 + 2.51960941000598i;  
h_12 = 0.999823389146385 - 0.000246785162909241i;  
h_21 = -1.000115600382660 - 0.000129304649930592i;  
h_22 = -6.55389515512306e-007 + 6.67541048071651e-006i;  
h_params = [h_11,h_12; h_21,h_22];  
%Convert to S-parameters  
s_params = h2s(h_params);
```

See Also

abcd2s | h2abcd | h2y | h2z | y2s | z2s

h2y

Convert hybrid h-parameters to Y-parameters

Syntax

```
y_params = h2y(h_params)
```

Description

`y_params = h2y(h_params)` converts the hybrid parameters `h_params` into the admittance parameters `y_params`. The `h_params` input is a complex 2-by-2-by- M array, representing M 2-port hybrid h-parameters. `y_params` is a complex 2-by-2-by- M array, representing M 2-port Y-parameters.

Alternatives

You can also use network parameter objects to perform network parameter conversions. For more information, see “RF Network Parameter Objects” on page 2-11.

Examples

Convert h-parameters to Y-parameters:

```
%Define a matrix of h-parameters.  
h_11 = 0.314441556185771 + 2.51960941000598i;  
h_12 = 0.999823389146385 - 0.000246785162909241i;  
h_21 = -1.000115600382660 - 0.000129304649930592i;  
h_22 = -6.55389515512306e-007 + 6.67541048071651e-006i;  
h_params = [h_11,h_12; h_21,h_22];  
%Convert to Y-parameters  
y_params = h2y(h_params);
```

See Also

abcd2z | h2abcd | h2s | h2y | h2y | s2z | y2z | z2h

h2z

Convert hybrid h-parameters to Z-parameters

Syntax

```
z_params = h2z(h_params)
```

Description

`z_params = h2z(h_params)` converts the hybrid parameters `h_params` into the impedance parameters `z_params`. The `h_params` input is a complex 2-by-2-by- M array, representing M 2-port hybrid h-parameters. `z_params` is a complex 2-by-2-by- M array, representing M 2-port Z-parameters.

Alternatives

You can also use network parameter objects to perform network parameter conversions. For more information, see “RF Network Parameter Objects” on page 2-11.

Examples

Convert h-parameters to Z-parameters:

```
%Define a matrix of h-parameters.  
h_11 = 0.314441556185771 + 2.51960941000598i;  
h_12 = 0.999823389146385 - 0.000246785162909241i;  
h_21 = -1.000115600382660 - 0.000129304649930592i;  
h_22 = -6.55389515512306e-007 + 6.67541048071651e-006i;  
h_params = [h_11,h_12; h_21,h_22];  
%Convert to Z-parameters  
z_params = h2z(h_params);
```

See Also

abcd2z | h2abcd | h2s | h2y | s2z | y2z | z2h

ispassive

Check passivity of N-port S-parameters

Syntax

```
[result, idx_nonpassive]= ispassive(sparams)
[result, idx_nonpassive] = ispassive(sparams_data, 'Impedance',z0)
```

Description

[result, idx_nonpassive]= ispassive(sparams) checks the passivity of N-port S-parameters. If all the S-parameters are passive, then ispassive sets flag equal to 1 (true). Otherwise, flag is equal to 0 (false). If flag is true, idx_non_passive is empty.

[result, idx_nonpassive] = ispassive(sparams_data, 'Impedance',z0) checks the passivity of the S-parameter data that is referenced to impedance, z0.

Input Arguments

sparams — RF Toolbox object

scalar S-parameters object | complex N -by- N -by- K array

RF Toolbox object containing S-parameter data or N-port S-parameters specified as a scalar S-parameters object or a complex N -by- N -by- K array.

sparams_data — S-parameter data referenced to z_0

N -by- N -by- K numeric matrix

S-parameter data referenced to z_0 specified as an N -by- N -by- K numeric matrix.

z0 — Reference impedance

complex scalar | vector o

Reference impedance, specified as a complex scalar or vector of length size (Sdata,3).

Output Arguments

result — Passivity of S-parameter data

logical scalar

Passivity of s-parameter data, returned as a logical scalar of 0 or 1. If all the S-parameters are passive, then `ispassive` sets `flag` equal to 1 (`true`). Otherwise, `flag` is equal to 0 (`false`). If `flag` is `true`, `idx_non_passive` is empty.

idx_nonpassive — Indices that correspond to the frequencies

vector of numeric integers

Indices that correspond to the frequencies where the S-parameter is not passive, returned as vector of numeric integers.

Examples

Check Passivity of S-parameter Data

Read a Touchstone data file.

```
S = sparameters('measured.s2p');
```

Check the passivity of the S-parameters.

```
[passivevar,idx] = ispassive(S);  
passivevar
```

```
passivevar =
```

```
0
```

Get the nonpassive S-parameters.

```
if ~passivevar  
    nonpassivevals = S.Parameters(:,:,idx);  
end
```

See Also

`rationalfit` | `rfmodel.rational.ispassive` | `s2tf` | `snp2smp`

makepassive

Enforce passivity of S-parameters

Syntax

```
sparams_passive = makepassive(sparams)  
hsp = makepassive(hs)
```

Description

`sparams_passive = makepassive(sparams)` makes an array of S-parameters passive. Both `sparams` and `sparams_passive` are N-by-N-by-M arrays representing *M* N-port S-parameters.

The `makepassive` function enforces the following conditions on `sparams`:

$$S(-j\omega) = S^*(j\omega)$$
$$\|S(j\omega)\|_2 \leq 1$$

The notation $\|S\|_2$ represents the 2-norm, or singular-value decomposition, of *S*.

`hsp = makepassive(hs)` creates a passive S-parameter object from the S-parameter object `hs`.

Input Arguments

hs

N-port S-parameters, specified as an RF Toolbox S-parameter object.

sparams

`sparams` can represent either an active network or a passive network. To check if `sparams` is passive, use the `ispassive` function.

Output Arguments

sparams_passive

The `makepassive` function uses a purely mathematical method to calculate `sparams_passive`. As a result, the array `sparams_passive` does not represent the same network as `sparams`. `sparams` and `sparams_passive` do not represent the same network unless `sparams` and `sparams_passive` are equal.

The more closely `sparams` represents a passive network, the better the approximation `sparams_passive` is to that network. Therefore, `makepassive` generates the most realistic results when `sparams` is active only due to small numerical errors.

Examples

Enforce passivity of the S-parameters that represent a passive network:

```
ckt = read(rfckt.passive, 'passive.s2p');
sparams = ckt.NetworkData.Data;
Is_Passive = ispassive(sparams)
sparams_new = makepassive(sparams);
Is_Passive = ispassive(sparams_new)
ckt.NetworkData.Data = sparams_new;
```

See Also

`ispassive`

powergain

Power gain of 2-port network

Syntax

```
g = powergain(s_params,z0,zs,zl,'Gt')
g = powergain(s_params,z0,zs,'Ga')
g = powergain(s_params,z0,zl,'Gp')
g = powergain(s_params,'Gmag')
g = powergain(s_params,'Gmsg')
```

```
g = powergain(hs,zs,zl,'Gt')
g = powergain(hs,zs,'Ga')
g = powergain(hs,zl,'Gp')
g = powergain(hs,'Gmag')
g = powergain(hs,'Gmsg')
```

Description

`g = powergain(s_params,z0,zs,zl,'Gt')` calculates the transducer power gain of the 2-port network `s_params`.

`g = powergain(s_params,z0,zs,'Ga')` calculates the available power gain of the 2-port network.

`g = powergain(s_params,z0,zl,'Gp')` calculates the operating power gain of the 2-port network.

`g = powergain(s_params,'Gmag')` calculates the maximum available power gain of the 2-port network.

`g = powergain(s_params,'Gmsg')` calculates the maximum stable gain of the 2-port network.

`g = powergain(hs,zs,zl,'Gt')` calculates the transducer power gain of the network represented by the S-parameter object `hs`.

`g = powergain(hs, zs, 'Ga')` calculates the available power gain of the network represented by the S-parameter object `hs`.

`g = powergain(hs, z1, 'Gp')` calculates the operating power gain of the network represented by the S-parameter object `hs`.

`g = powergain(hs, 'Gmag')` calculates the maximum available power gain of the network represented by the S-parameter object `hs`.

`g = powergain(hs, 'Gmsg')` calculates the maximum stable gain of the network represented by the S-parameter object `hs`.

Input Arguments

hs — 2-port S-parameters

S-parameter object

2-port S-parameters, specified as an RF Toolbox S-parameter object.

s_params — 2-port S-parameters

array of complex numbers

2-port S-parameters, specified as a complex 2-by-2-by-*N* array.

z0 — Reference impedance

50 (default) | positive scalar

Reference impedance in ohms, specified as a positive scalar. If the first input argument is an S-parameter object `hs`, the function uses `hs.Impedance` for the reference impedance.

z1 — Load impedance

50 (default) | positive scalar

Load impedance in ohms, specified as a positive scalar.

zs — Source impedance

50 (default) | positive scalar

Source impedance in ohms, specified as a positive scalar.

Output Arguments

g — Power gain

vector

Unitless power gain values, returned as a vector. To obtain power gain in decibels, use $10 \cdot \log_{10}(g)$.

If the specified type of power gain is undefined for one or more of the specified S-parameter values in `s_params`, the `powergain` function returns NaN. As a result, `g` is either NaN or a vector that contains one or more NaN entries.

Examples

Calculate power gains for a sample 2-port network:

```
s11 = 0.61*exp(j*165/180*pi);
s21 = 3.72*exp(j*59/180*pi);
s12 = 0.05*exp(j*42/180*pi);
s22 = 0.45*exp(j*(-48/180)*pi);
sparam = [s11 s12; s21 s22];
z0 = 50;
zs = 10 + j*20;
z1 = 30 - j*40;
%Calculate the transducer power gain of the network
Gt = powergain(sparam,z0,zs,z1,'Gt')
%Calculate the available power gain of the network
Ga = powergain(sparam,z0,zs,'Ga')
%Calculate the operating power gain of the network
Gp = powergain(sparam,z0,z1,'Gp')
%Calculate the maximum available power gain of the network
Gmag = powergain(sparam,'Gmag')
%Calculate the maximum stable power gain of the network
Gmsg = powergain(sparam,'Gmsg')
```

See Also

`s2tf`

rationalfit

Approximate data using stable rational function object

Syntax

```
fit = rationalfit(freq,data)
fit = rationalfit(freq,data,tol)
fit = rationalfit( ____,Name,Value)
[fit,errdb] = rationalfit(...)

fit = rationalfit(s_obj,i,j...)
```

Description

`fit = rationalfit(freq,data)` fits a rational function object of the form

$$F(s) = \sum_{k=1}^n \frac{C_k}{s - A_k} + D, \quad s = j * 2\pi f$$

to the complex vector `data` over the frequency values in the positive vector `freq`. The function returns a handle to the rational function object, `h`, with properties `A`, `C`, `D`, and `Delay`.

`fit = rationalfit(freq,data,tol)` fits a rational function object to complex data and constrains the error of the fit according to the optional input argument `tol`.

`fit = rationalfit(____,Name,Value)` fits a rational function object of the form

$$F(s) = \left(\sum_{k=1}^n \frac{C_k}{s - A_k} + D \right) e^{-s \cdot \text{Delay}}, \quad s = j * 2\pi f$$

with additional options specified by one or more `Name, Value` pair arguments. These arguments offer finer control over the performance and accuracy of the fitting algorithm.

`[fit,errldb] = rationalfit(...)` fits a rational function object to complex data and also returns ERRDB, which is the achieved error.

`fit = rationalfit(s_obj,i,j,...)` fits S_{ij} using `FREQ = s_obj.Frequencies` and `DATA = rfparam(s_obj,i,j)` for s-parameter object, `s_obj`.

Examples

Rational Function Approximation of S-parameter Data

Fit a rational function object to S-parameter data, and compare the results by plotting the object against the data.

Read the S-parameter data into an RF data object.

```
orig_data = read(rfdata.data, 'passive.s2p');
freq = orig_data.Freq;
data = orig_data.S_Parameters(1,1,:);
```

Fit a rational function to the data using `rationalfit`.

```
fit_data = rationalfit(freq,data)
```

```
fit_data =
```

```
rfmodel.rational with properties:
```

```
    A: [19x1 double]
    C: [19x1 double]
    D: 0
    Delay: 0
    Name: 'Rational Function'
```

Compute the frequency response of the rational function using `freqresp`.

```
[resp,freq] = freqresp(fit_data,freq);
```

Plot the magnitude of the original data against the rational function approximation. S_{11} data appears in blue, and the rational function appears in red. Scaling the frequency values by $1e9$ converts them to units of GHz.

```

figure
title('Rational fitting of S11 magnitude')
plot(orig_data,'S11','dB')
hold on
plot(freq/1e9,20*log10(abs(resp)),'r');

```

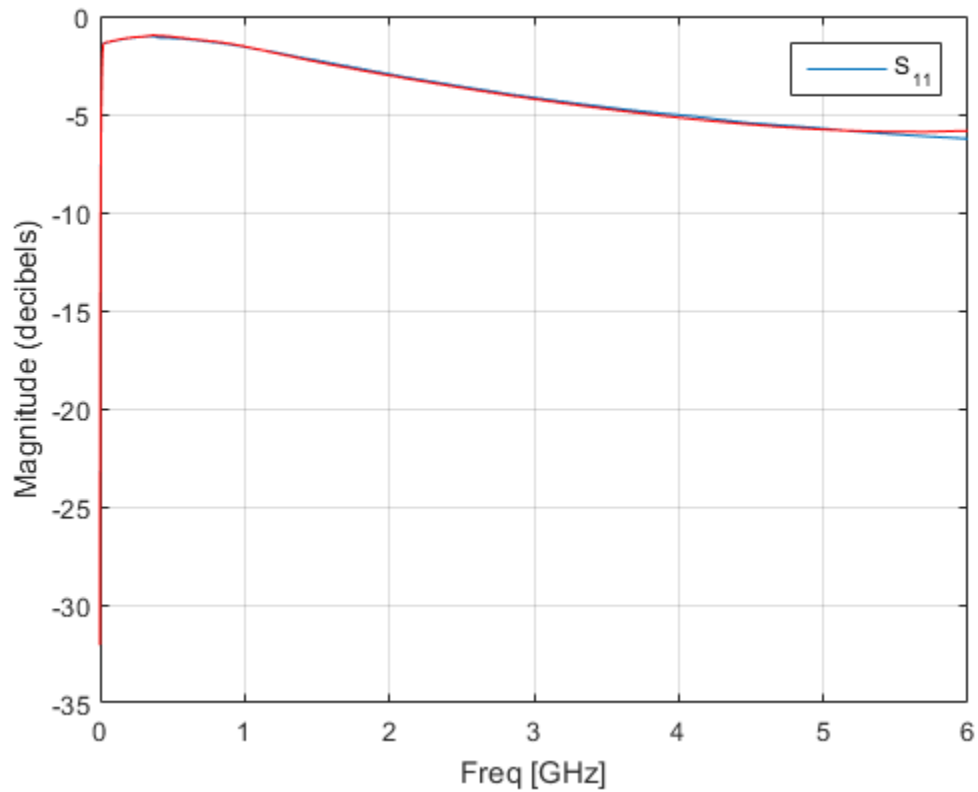

Plot the angle of the original data against the rational function approximation.

```

figure
title('Rational fitting of S11 angle')
plot(orig_data,'S11','Angle (radians)')
hold on
plot(freq/1e9,unwrap(angle(resp)),'r')

```

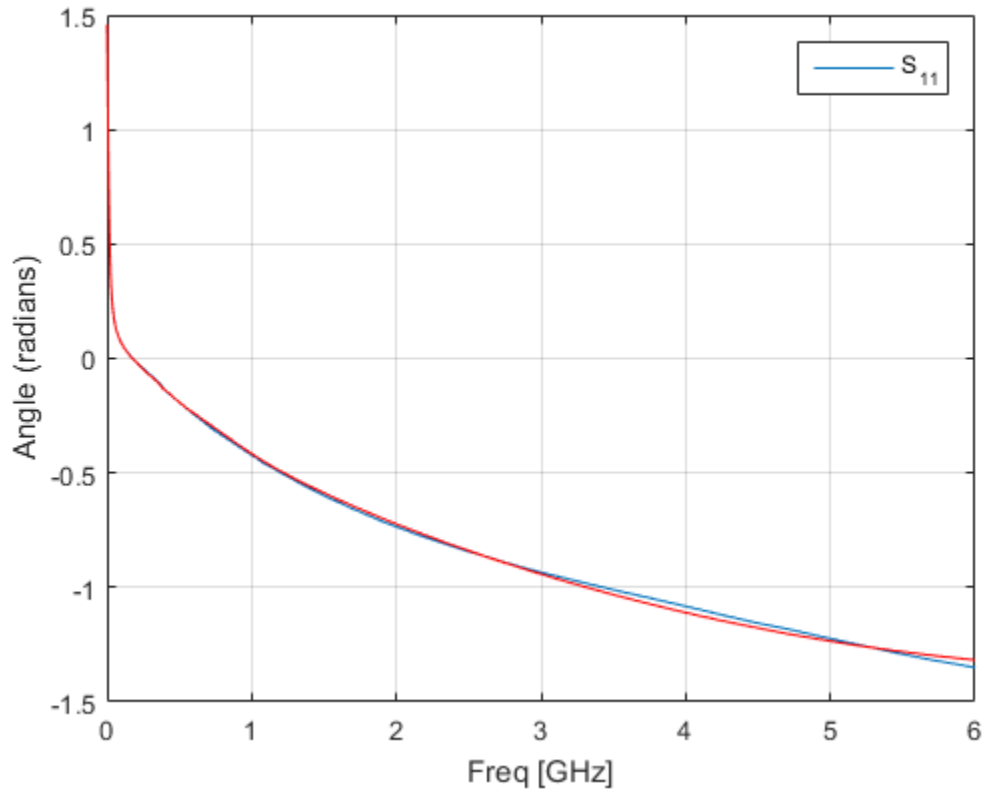

Fit S-Parameter Object

Use rational fit to fit an S-parameter object from the file 'passive.s2p'.

```
S = sparameters('passive.s2p');
fit = rationalfit(S,1,1,'TendsToZero',false)
```

```
fit =
```

```
rfmodel.rational with properties:
```

```
A: [5x1 double]
C: [5x1 double]
```

```
D: -0.4843
Delay: 0
Name: 'Rational Function'
```

Input Arguments

freq — Frequencies

vector of positive numbers

Frequencies over which the function fits a rational object, specified as a vector of length M .

data — Data to fit

N -by- N -by- M array of complex numbers (default) | vector of complex numbers

Data to fit, specified as an N -by- N -by- M array of complex numbers. The function fits N^2 rational functions to the data along the M (frequency) dimension.

tol — Error tolerance

-40 (default) | scalar

Error tolerance ε , specified as a scalar in units of dB. The error-fitting equation is

$$10^{\varepsilon/20} \geq \frac{\sqrt{\sum_{k=1}^n W_k |F_0\{f_k\} - F(s)|^2}}{\sqrt{\sum_{k=1}^n W_k |F_0\{f_k\}|^2}}$$

where

- ε is the specified value of **tol**.
- F_0 is the value of the original data (**data**) at the specified frequency f_k (**freq**).
- F is the value of the rational function at $s = j2\pi f$.
- W is the weighting of the data.

`rationalfit` computes the relative error as a vector containing the dependent values of the fit data. If the object does not fit the original data within the specified tolerance, a warning message appears.

s_obj — S-parameter object

network parameter object

S-parameters, specified as an RF Toolbox network parameter object. To create this type of object, use the `sparameters` function.

i — Row index

positive integer

Row index of data to plot, specified as a positive integer.

j — Column index

positive integer

Column index of data to plot, specified as a positive integer.

Name-Value Pair Arguments

Specify optional comma-separated pairs of `Name`, `Value` arguments. `Name` is the argument name and `Value` is the corresponding value. `Name` must appear inside single quotes (' '). You can specify several name and value pair arguments in any order as `Name1`, `Value1`, ..., `NameN`, `ValueN`.

'DelayFactor' — Delay factor

0 (default) | scalar from 0 to 1

Scaling factor that controls the amount of delay to fit to the data, specified as the comma-separated pair consisting of `'DelayFactor'` and a scalar between 0 and 1 inclusive. The `Delay` parameter, τ , of the rational function object is equal to the specified value of `'DelayFactor'` times an estimate of the group delay of the data. If the original data has delay, increasing this value might allow `rationalfit` to fit the data with a lower-order object.

'IterationLimit' — Maximum number of rationalfit iterations

[4,12] (default) | vector of positive integers

Maximum number of `rationalfit` iterations, specified as a vector of positive integers. Provide a two-element vector to specify minimum and maximum [`M1` `M2`]. Increasing

the limit extends the time that the algorithm takes to produce a fit, but it might produce more accurate results.

'NPoles' — Number of poles

[0 48] (default) | nonnegative integer | vector of two nonnegative integers

Number of poles A_k of the rational function, specified as the comma-separated pair consisting of 'NPoles' and an integer n or range of possible values of n .

To help `rationalfit` produce an accurate fit, choose a maximum value of `npoles` greater than or equal to twice the number of peaks on a plot of the data in the frequency domain.

After completing a rational fit, the function removes coefficient sets whose residues (C_k) are zero. Thus, when you specify a range for `npoles`, the number of poles of the fit may be less than `npoles(1)`.

'TendsToZero' — Asymptotic behavior of fit

true (default) | false

Asymptotic behavior of the rational function as frequency approaches infinity, specified as the comma-separated pair consisting of 'TendsToZero' and a logical value. When this argument is `true`, the resulting rational function variable D is zero, and the function tends to zero. A value of `false` allows a nonzero value for D .

'Tolerance' — Error tolerance

-40 (default) | scalar

Error tolerance ϵ , specified as the comma-separated pair consisting of 'Tolerance' and a scalar in units of dB. The error-fitting equation is

$$10^{\epsilon/20} \geq \frac{\sqrt{\sum_{k=1}^n W_k |F_0\{f_k\} - F(s)|^2}}{\sqrt{\sum_{k=1}^n W_k |F_0\{f_k\}|^2}}$$

where

- ε is the specified tolerance.
- F_0 is the value of the original data (`data`) at the specified frequency f_k (`freq`).
- F is the value of the rational function at $s = j2\pi f$.
- W is the weighting of the data.

If the object does not fit the original data within the specified tolerance, the function throws a warning.

'WaitBar' — Graphical wait bar

false (default) | true

Logical value that toggles display of the graphical wait bar during fitting, specified as the comma-separated pair consisting of 'WaitBar' and either `true` or `false`. The `true` setting shows the graphical wait bar, and the `false` setting hides it. If you expect `rationalfit` to take a long time, and you want to monitor its progress, set 'WaitBar' to `true`.

'Weight' — Weighting of data

ones(size(freq)) (default) | vector of positive numbers

Weighting of the data at each frequency, specified as the comma-separated pair consisting of 'Weight' and a vector of positive numbers or an array same as that of the data. Each entry in `weight` corresponds to a frequency in `freq`, so the length of `weight` must be equal to the length of `freq`. Increasing the weight at a particular frequency improves the object fitting at that frequency. Specifying a weight of 0 at a particular frequency causes `rationalfit` to ignore the corresponding data point.

Output Arguments

fit — Rational function object

rfmodel.rational object

One or more rational function objects, returned as an N -by- N `rfmodel.rational` object. The number of dimensions in `data` determines the dimensionality of `h`.

errdb — Relative error

-40 (default) | double

Relative error achieved, returned as a `double`, in dB.

More About

Tips

To see how well the object fits the original data, use the `freqresp` function to compute the frequency response of the object. Then, plot the original data and the frequency response of the rational function object. For more information, see the `freqresp` reference page or the examples in the next section.

References

Gustavsen,B and A.Semlyen, “Rational approximation of frequency domain responses by vector fitting,” *IEEE Trans. Power Delivery*, Vol. 14, No. 3, pp. 1052–1061, July 1999.

Zeng,R and J. Sinsky, “Modified Rational Function Modeling Technique for High Speed Circuits,” *IEEE MTT-S Int. Microwave Symp. Dig.*, San Francisco, CA, June 11–16, 2006.

See Also

`freqresp` | `rfmodel.rational` | `s2tf` | `timeresp` | `writeva`

rftool

Open RF Analysis Tool (RF Tool)

Syntax

rftool

Description

rftool opens the RF Tool interface. Use this tool to:

- Create circuit components and set their parameters.
- Analyze components over a specified frequency range and step size.
- Plot the analysis results.
- Import component objects to and export them from the MATLAB workspace.
- Save RF Tool sessions for later use.

For more information, see “The RF Design and Analysis App” on page 5-2.

The following figure shows the RF Tool in its default state.

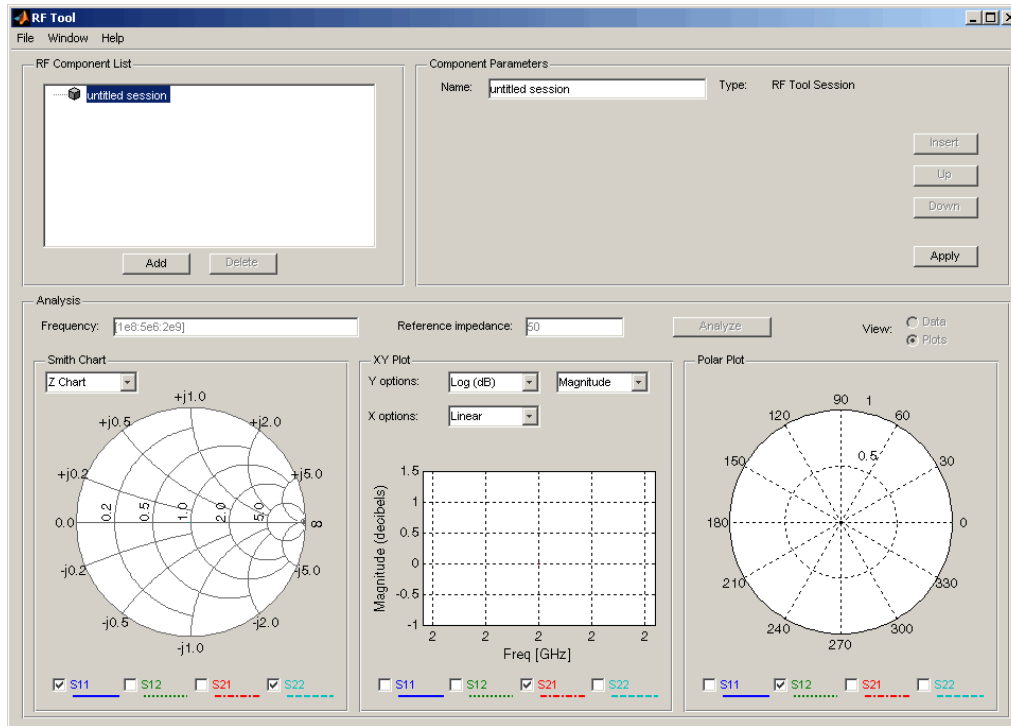

rlgc2s

Convert RLGC transmission line parameters to S-parameters

Syntax

```
s_params = rlgc2s(R,L,G,C,length,freq,z0)
s_params = rlgc2s(R,L,G,C,length,freq)
```

Description

`s_params = rlgc2s(R,L,G,C,length,freq,z0)` transforms RLGC transmission line parameter data into S-parameters.

`s_params = rlgc2s(R,L,G,C,length,freq)` transforms RLGC transmission line parameter data into S-parameters with a reference impedance of 50 Ω .

Input Arguments

R

Specify an N -by- N -by- M array of distributed resistances, in units of Ω/m . The N -by- N matrices must be real symmetric, the diagonal terms must be nonnegative, and the off-diagonal terms must be nonnegative.

L

Specify an N -by- N -by- M array of distributed inductances, in units of H/m . The N -by- N matrices must be real symmetric, the diagonal terms must be positive, and the off-diagonal terms must be nonnegative.

G

Specify an N -by- N -by- M array of distributed conductances, in units of S/m . The N -by- N matrices must be real symmetric, the diagonal terms must be nonnegative, and the off-diagonal terms must be nonpositive.

C

Specify an N -by- N -by- M array of distributed capacitances, in units of F/m. The matrices must be real symmetric, the diagonal terms must be positive, and the off-diagonal terms must be nonpositive.

length

Specify the length of the transmission line in meters.

freq

Specify the vector of M frequencies over which the transmission line parameters are defined.

z0 — Reference Impedance

50 (default) | scalar

Reference impedance in ohms, specified as a scalar, of the resulting S-parameters.

Output Arguments

s_params

The output is a $2N$ -by- $2N$ -by- M array of S-parameters. The following figure describes the port ordering convention of the output.



$$\begin{bmatrix} S_{11} & S_{12} & S_{13} & S_{14} \\ S_{21} & S_{22} & S_{23} & S_{24} \\ S_{31} & S_{32} & S_{33} & S_{34} \\ S_{41} & S_{42} & S_{43} & S_{44} \end{bmatrix}$$

This port ordering convention assumes that:

- Each $2N$ -by- $2N$ matrix consists of N input terminals and N output terminals.

- The first N ports (1 through N) of the S-parameter matrix are input ports.
- The last N ports ($N + 1$ through $2N$) are output ports.

To reorder ports after using this function, use the `snp2smp` function.

Definitions

The following figure illustrates the RLGC transmission line model.

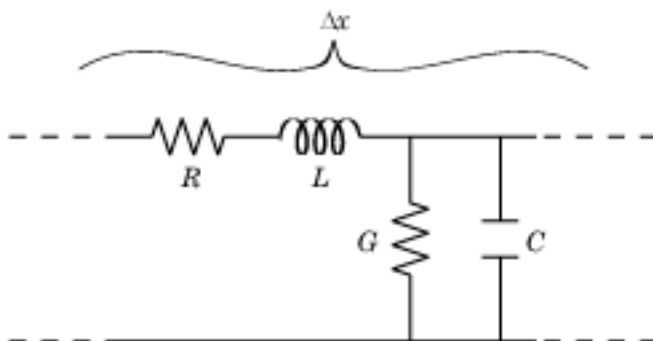

The representation consists of:

- The distributed resistance, R , of the conductors, represented by a series resistor.
- The distributed inductance, L , represented by a series inductor.
- The distributed conductance, G ,
- The distributed capacitance, C , between the two conductors, represented by a shunt capacitor.

RLGC component units are all per unit length Δx .

Examples

Convert RLGC transmission line parameters into S-parameters:

```
%Define transmission line variables
length = 1e-3;
freq = 1e9;
```

```
z0 = 50;  
R = 50;  
L = 1e-9;  
G = .01;  
C = 1e-12;  
% Calculate S-parameters  
s_params = rlgc2s(R,L,G,C,length,freq,z0)
```

References

Bhatti, A. Aziz. “A computer Based Method for Computing the N-Dimensional Generalized ABCD Parameter Matrices of N-Dimensional Systems with Distributed Parameters.” *Southeastern Symposium on System Theory*. SSST, 22nd Conference, 11–13 March 1990, pp. 590–593.

See Also

s2rlgc

s2abcd

Convert S-parameters to ABCD-parameters

Syntax

```
abcd_params = s2abcd(s_params, z0)
```

Description

`abcd_params = s2abcd(s_params, z0)` converts the scattering parameters `s_params` into the ABCD-parameters `abcd_params`. The `s_params` input is a complex $2N$ -by- $2N$ -by- M array, representing M $2N$ -port S-parameters. `z0` is the reference impedance; its default is 50 ohms. `abcd_params` is a complex $2N$ -by- $2N$ -by- M array, representing M 2-port ABCD-parameters. The output ABCD-parameter matrices have distinct A , B , C , and D submatrices:

$$\begin{bmatrix} [A] & [B] \\ [C] & [D] \end{bmatrix}$$

Alternatives

You can also use network parameter objects to perform network parameter conversions. For more information, see “RF Network Parameter Objects” on page 2-11.

Examples

Convert S-parameters to ABCD-parameters:

```
%Define a matrix of S-parameters
s_11 = 0.61*exp(j*165/180*pi);
s_21 = 3.72*exp(j*59/180*pi);
s_12 = 0.05*exp(j*42/180*pi);
s_22 = 0.45*exp(j*(-48/180)*pi);
```

```
s_params = [s_11 s_12; s_21 s_22];  
z0 = 50;  
%Convert to ABCD-parameters  
abcd_params = s2abcd(s_params,z0)
```

See Also

abcd2s | h2abcd | s2h | s2y | s2z | y2abcd | z2abcd

s2h

Convert S-parameters to hybrid h-parameters

Syntax

```
h_params = s2h(s_params, z0)
```

Description

`h_params = s2h(s_params, z0)` converts the scattering parameters `s_params` into the hybrid parameters `h_params`. The `s_params` input is a complex 2-by-2-by- M array, representing M 2-port S-parameters. `z0` is the reference impedance; its default is 50 ohms. `h_params` is a complex 2-by-2-by- M array, representing M 2-port hybrid h-parameters.

Alternatives

You can also use network parameter objects to perform network parameter conversions. For more information, see “RF Network Parameter Objects” on page 2-11.

Examples

Convert S-parameters to h-parameters:

```
%Define a matrix of S-parameters
s_11 = 0.61*exp(j*165/180*pi);
s_21 = 3.72*exp(j*59/180*pi);
s_12 = 0.05*exp(j*42/180*pi);
s_22 = 0.45*exp(j*(-48/180)*pi);
s_params = [s_11 s_12; s_21 s_22];
z0 = 50;
%Convert to h-parameters
h_params = s2h(s_params, z0)
```

See Also

h2s

s2rlgc

Convert S-parameters to RLGC transmission line parameters

Syntax

```
rlgc_params = s2rlgc(s_params,length,freq,z0)
rlgc_params = s2rlgc(s_params,length,freq)
```

Description

`rlgc_params = s2rlgc(s_params,length,freq,z0)` transforms multi-port S-parameter data into a frequency-domain representation of an RLGC transmission line.

`rlgc_params = s2rlgc(s_params,length,freq)` transforms multi-port S-parameter data into RLGC transmission line parameters using a reference impedance of 50 Ω .

Input Arguments

s_params

Specify a $2N$ -by- $2N$ -by- M array of S-parameters to transform into RLGC transmission line parameters. The following figure describes the port ordering convention assumed by the function.



$$\begin{bmatrix} S_{11} & S_{12} & S_{13} & S_{14} \\ S_{21} & S_{22} & S_{23} & S_{24} \\ S_{31} & S_{32} & S_{33} & S_{34} \\ S_{41} & S_{42} & S_{43} & S_{44} \end{bmatrix}$$

The function assumes that:

- Each $2N$ -by- $2N$ matrix consists of N input terminals and N output terminals.
- The first N ports (1 through N) of the S-parameter matrix are input ports.
- The last N ports ($N + 1$ through $2N$) are output ports.

To reorder ports before using this function, use the `snp2smp` function.

length

Specify the length of the transmission line in meters.

freq

Specify the vector of M frequencies over which the S-parameter array `s_params` is defined.

z0 — Reference Impedance

50 (default) | scalar

Reference impedance in ohms, specified as a scalar, of the resulting S-parameters.

Output Arguments

rlgc_params

The output `rlgc_params` is structure whose fields are N -by- N -by- M arrays of transmission line parameters. Each of the M N -by- N matrices correspond to a frequency in the input vector `freq`.

- `rlgc_params.R` is an array of distributed resistances, in units of Ω/m . The matrices are real symmetric, the diagonal terms are nonnegative, and the off-diagonal terms are nonnegative.
- `rlgc_params.L` is an array of distributed inductances, in units of H/m . The matrices are real symmetric, the diagonal terms are positive, and the off-diagonal terms are nonnegative.
- `rlgc_params.G` is an array of distributed conductances, in units of S/m . The matrices are real symmetric, the diagonal terms are nonnegative, and the off-diagonal terms are nonpositive.

- `rlgc_params.C` is an array of distributed capacitances, in units of F/m. The matrices are real symmetric, the diagonal terms are positive, and the off-diagonal terms are nonpositive.
- `rlgc_params.Zc` is an array of complex characteristic line impedances, in ohms.
- `rlgc_params.alpha` is an array of real attenuation coefficients, in units of Np/m.
- `rlgc_params.beta` is an array of real phase constants, in units of rad/m.

Definitions

The following figure illustrates the RLGC transmission line model.

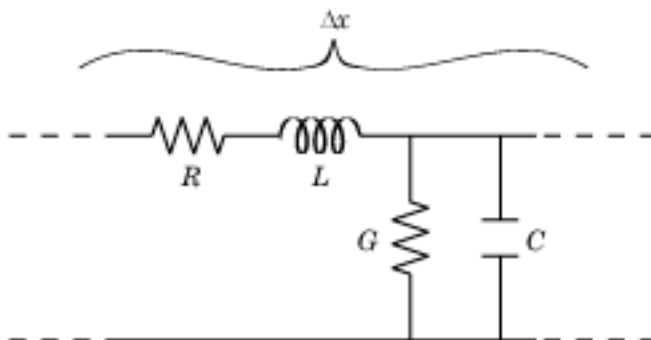

The representation consists of:

- The distributed resistance, R , of the conductors, represented by a series resistor.
- The distributed inductance, L , of the conductors, represented by a series inductor.
- The distributed conductance, G , between the two conductors, represented by a shunt resistor.
- The distributed capacitance, C , between the two conductors, represented by a shunt capacitor.

RLGC component units are all per unit length Δx .

Examples

Convert S-parameters to RLGC transmission line parameters:

```
s_11 = 0.000249791883190134 - 9.42320545953709e-005i;  
s_12 = 0.999250283783862 - 0.000219770154524734i;  
s_21 = 0.999250283783863 - 0.000219770154524756i;  
s_22 = 0.000249791883190079 - 9.42320545953931e-005i;  
s_params = [s_11,s_12; s_21,s_22];  
length = 1e-3;  
freq = 1e9;  
z0 = 50;  
rlgc_params = s2rlgc(s_params,length,freq,z0)
```

References

Degerstrom, M.J., B.K. Gilbert, and E.S. Daniel. “Accurate resistance, inductance, capacitance, and conductance (RLCG) from uniform transmission line measurements.” *Electrical Performance of Electronic Packaging*,. IEEE-EPEP, 18th Conference, 27–29 October 2008, pp. 77–80.

Sampath, M.K. “On addressing the practical issues in the extraction of RLGC parameters for lossy multi-conductor transmission lines using S-parameter models.” *Electrical Performance of Electronic Packaging*,. IEEE-EPEP, 18th Conference, 27–29 October 2008, pp. 259–262.

See Also

rlgc2s

s2s

Convert S-parameters to S-parameters with different impedance

Syntax

```
s_params_new = s2s(s_params, z0)
s_params_new = s2s(s_params, z0, z0_new)
```

Description

`s_params_new = s2s(s_params, z0)` converts the scattering parameters `s_params` with reference impedance `z0` into the scattering parameters `s_params_new` with a default reference impedance of 50 ohms. Both `s_params` and `s_params_new` are complex N -by- N -by- M arrays, representing M N -port S-parameters.

`s_params_new = s2s(s_params, z0, z0_new)` converts the scattering parameters `s_params` with reference impedance `z0` into the scattering parameters `s_params_new` with reference impedance `z0_new`.

Alternatives

The `newref` function changes the reference impedance of S-parameters objects.

Examples

Convert S-parameters from one reference impedance to another reference impedance:

```
%Define a matrix of S-parameters
s_11 = 0.61*exp(j*165/180*pi);
s_21 = 3.72*exp(j*59/180*pi);
s_12 = 0.05*exp(j*42/180*pi);
s_22 = 0.45*exp(j*(-48/180)*pi);
s_params = [s_11 s_12; s_21 s_22];
z0 = 50;
```

```
z0_new = 40;  
%Convert to new reference impedance  
s_params_new = s2s(s_params,z0,z0_new)
```

See Also

abcd2s | h2s | s2abcd | s2h | s2y | s2z | y2s | z2s

s2scc

Convert single-ended S-parameters to common-mode S-parameters (S_{cc})

Syntax

```
scc_params = s2scc(s_params)
scc_params = s2scc(s_params,option)
```

Description

`scc_params = s2scc(s_params)` converts the $2N$ -port, single-ended S-parameters, `s_params`, to N -port, common-mode S-parameters, `scc_params`. `scc_params` is a complex N -by- N -by- M array that represents M N -port, common-mode S-parameters (S_{cc}).

`scc_params = s2scc(s_params,option)` converts S-parameters based on the optional `option` argument, which indicates the port-ordering convention of the S-parameters.

Input Arguments

s_params — S-parameters

array

S-parameters, specified as a complex 4-by-4-by- M array, that represents M 4-port S-parameters.

option — Port order

1 (default) | 2 | 3

Port order, specified as 1, 2, 3, determines how the function orders the ports:

- 1 — `s2scc` pairs the odd-numbered ports together first, followed by the even-numbered ports. For example, in a single-ended, 8-port network:
 - Ports 1 and 3 become common-mode pair 1.
 - Ports 5 and 7 become common-mode pair 2.

- Ports 2 and 4 become common-mode pair 3.
- Ports 6 and 8 become common-mode pair 4.

The following figure illustrates this convention for an 8-port device.

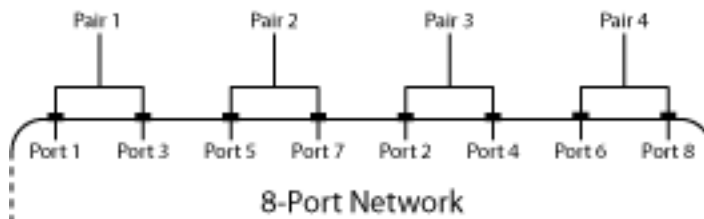

- 2 — s2scc pairs the input and output ports in ascending order. For example, in a single-ended, 8-port network:
 - Ports 1 and 2 become common-mode pair 1.
 - Ports 3 and 4 become common-mode pair 2.
 - Ports 5 and 6 become common-mode pair 3.
 - Ports 7 and 8 become common-mode pair 4.

The following figure illustrates this convention for an 8-port device.

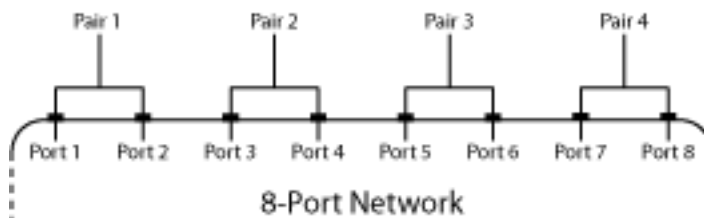

- 3 — s2scc pairs the input ports in ascending order and the output ports in descending order. For example, in a single-ended, 8-port network:
 - Ports 1 and 2 become common-mode pair 1.
 - Ports 3 and 4 become common-mode pair 2.
 - Ports 8 and 7 become common-mode pair 3.
 - Ports 6 and 5 become common-mode pair 4.

The following figure illustrates this convention for an 8-port device.

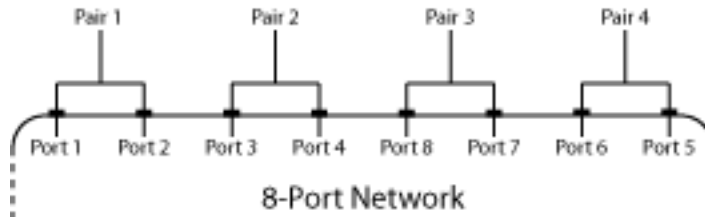

Examples

Convert network data to common-mode S-parameters using the default port ordering:

```

ckt = read(rfckt.passive, 'default.s4p');
s4p = ckt.NetworkData.Data;
s_cc = s2scc(s4p);

```

References

Fan, W., A. C. W. Lu, L. L. Wai, and B. K. Lok. "Mixed-Mode S-Parameter Characterization of Differential Structures." Electronic Packaging Technology Conference, pp. 533–537, 2003.

See Also

s2scc | s2sdc | s2sdd | s2smm | smm2s

s2scd

Convert 4-port, single-ended S-parameters to 2-port, cross-mode S-parameters (S_{cd})

Syntax

```
scd_params = s2scd(s_params)
scd_params = s2scd(s_params,option)
```

Description

`scd_params = s2scd(s_params)` converts the $2N$ -port, single-ended S-parameters, `s_params`, to N -port, cross-mode S-parameters, `scd_params`. `scd_params` is a complex N -by- N -by- M array that represents M N -port, cross-mode S-parameters (S_{cd}).

`scd_params = s2scd(s_params,option)` converts S-parameters based on the optional `option` argument, which indicates the port-ordering convention of the S-parameters.

Input Arguments

s_params — S-parameters

array

S-parameters, specified as a complex 4-by-4-by- M array, that represents M 4-port S-parameters.

option — Port order

1 (default) | 2 | 3

Port order, specified as 1, 2, 3, determines how the function orders the ports:

- 1 — `s2scd` pairs the odd-numbered ports together first, followed by the even-numbered ports. For example, in a single-ended, 8-port network:
 - Ports 1 and 3 become cross-mode pair 1.
 - Ports 5 and 7 become cross-mode pair 2.

- Ports 2 and 4 become cross-mode pair 3.
- Ports 6 and 8 become cross-mode pair 4.

The following figure illustrates this convention for an 8-port device.

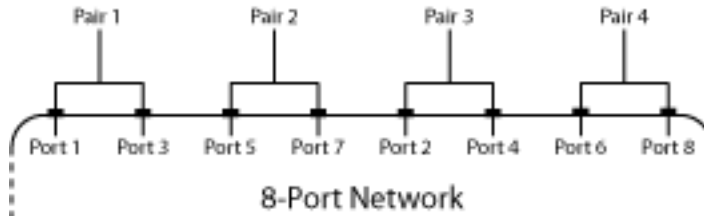

- 2 — s2scd pairs the input and output ports in ascending order. For example, in a single-ended, 8-port network:
 - Ports 1 and 2 become cross-mode pair 1.
 - Ports 3 and 4 become cross-mode pair 2.
 - Ports 5 and 6 become cross-mode pair 3.
 - Ports 7 and 8 become cross-mode pair 4.

The following figure illustrates this convention for an 8-port device.

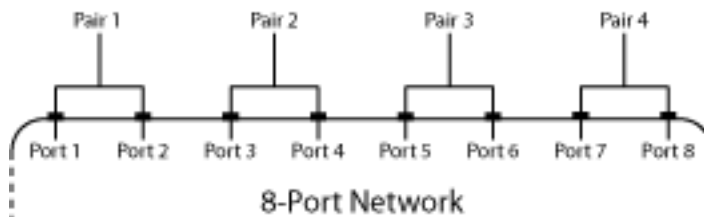

- 3 — s2scd pairs the input ports in ascending order and the output ports in descending order. For example, in a single-ended, 8-port network:
 - Ports 1 and 2 become cross-mode pair 1.
 - Ports 3 and 4 become cross-mode pair 2.
 - Ports 8 and 7 become cross-mode pair 3.
 - Ports 6 and 5 become cross-mode pair 4.

The following figure illustrates this convention for an 8-port device.

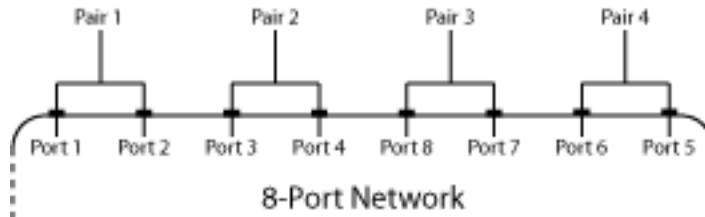

Examples

Convert network data to cross-mode S-parameters using the default port ordering:

```
ckt = read(rfckt.passive, 'default.s4p');  
s4p = ckt.NetworkData.Data;  
s_cd = s2scd(s4p);
```

References

Fan, W., A. C. W. Lu, L. L. Wai, and B. K. Lok. “Mixed-Mode S-Parameter Characterization of Differential Structures.” Electronic Packaging Technology Conference, pp. 533–537, 2003.

See Also

s2scc | s2sdc | s2sdd | s2smm | smm2s

s2sdc

Convert 4-port, single-ended S-parameters to 2-port, cross-mode S-parameters (S_{dc})

Syntax

```
sdc_params = s2sdc(s_params)
sdc_params = s2sdc(s_params,option)
```

Description

`sdc_params = s2sdc(s_params)` converts the $2N$ -port, single-ended S-parameters, `s_params`, to N -port, cross-mode S-parameters, `sdc_params`. `sdc_params` is a complex N -by- N -by- M array that represents M N -port, cross-mode S-parameters (S_{dc}).

`sdc_params = s2sdc(s_params,option)` converts S-parameters based on the optional `option` argument, which indicates the port-ordering convention of the S-parameters.

Input Arguments

s_params — S-parameters

array

S-parameters, specified as a complex 4-by-4-by- M array, that represents M 4-port S-parameters.

option — Port order

1 (default) | 2 | 3

Port order, specified as 1, 2, 3, determines how the function orders the ports:

- 1 — `s2sdc` pairs the odd-numbered ports together first, followed by the even-numbered ports. For example, in a single-ended, 8-port network:
 - Ports 1 and 3 become cross-mode pair 1.
 - Ports 5 and 7 become cross-mode pair 2.

- Ports 2 and 4 become cross-mode pair 3.
- Ports 6 and 8 become cross-mode pair 4.

The following figure illustrates this convention for an 8-port device.

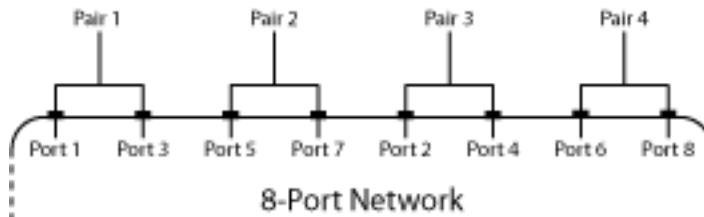

- 2 — s2sdc pairs the input and output ports in ascending order. For example, in a single-ended, 8-port network:
 - Ports 1 and 2 become cross-mode pair 1.
 - Ports 3 and 4 become cross-mode pair 2.
 - Ports 5 and 6 become cross-mode pair 3.
 - Ports 7 and 8 become cross-mode pair 4.

The following figure illustrates this convention for an 8-port device.

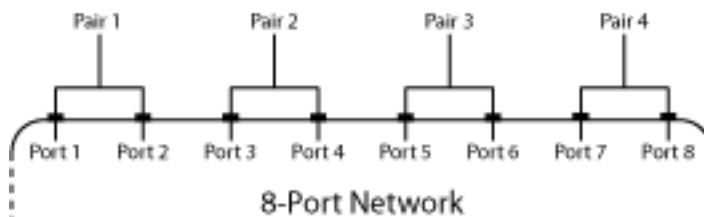

- 3 — s2sdc pairs the input ports in ascending order and the output ports in descending order. For example, in a single-ended, 8-port network:
 - Ports 1 and 2 become cross-mode pair 1.
 - Ports 3 and 4 become cross-mode pair 2.
 - Ports 8 and 7 become cross-mode pair 3.
 - Ports 6 and 5 become cross-mode pair 4.

The following figure illustrates this convention for an 8-port device.

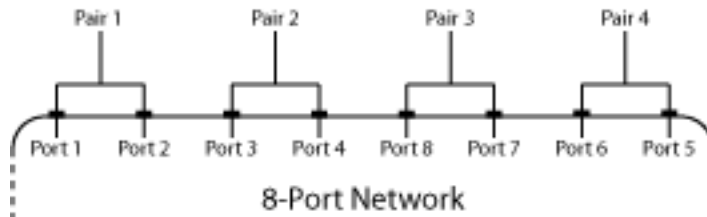

Examples

Convert network data to cross-mode S-parameters using the default port ordering:

```
ckt = read(rfckt.passive, 'default.s4p');  
s4p = ckt.NetworkData.Data;  
s_dc = s2sdc(s4p);
```

References

Fan, W., A. C. W. Lu, L. L. Wai, and B. K. Lok. "Mixed-Mode S-Parameter Characterization of Differential Structures." Electronic Packaging Technology Conference, pp. 533–537, 2003.

See Also

s2scc | s2scd | s2sdd | s2smm | smm2s

s2sdd

Convert 4-port, single-ended S-parameters to 2-port, differential-mode S-parameters (S_{dd})

Syntax

```
sdd_params = s2sdd(s_params)
sdd_params = s2sdd(s_params,option)
```

Description

`sdd_params = s2sdd(s_params)` converts the $2N$ -port, single-ended S-parameters, `s_params`, to N -port, differential-mode S-parameters, `sdd_params`. `sdd_params` is a complex N -by- N -by- M array that represents M N -port, differential-mode S-parameters (S_{cd}).

`sdd_params = s2sdd(s_params,option)` converts S-parameters based on the optional `option` argument, which indicates the port-ordering convention of the S-parameters.

Input Arguments

s_params — S-parameters

array

S-parameters, specified as a complex 4-by-4-by- M array, that represents M 4-port S-parameters.

option — Port order

1 (default) | 2 | 3

Port order, specified as 1, 2, 3, determines how the function orders the ports:

- 1 — `s2sdd` pairs the odd-numbered ports together first, followed by the even-numbered ports. For example, in a single-ended, 8-port network:
 - Ports 1 and 3 become differential-mode pair 1.
 - Ports 5 and 7 become differential-mode pair 2.

- Ports 2 and 4 become differential-mode pair 3.
- Ports 6 and 8 become differential-mode pair 4.

The following figure illustrates this convention for an 8-port device.

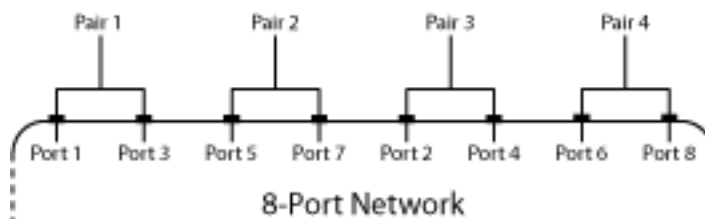

- 2 — s2sdd pairs the input and output ports in ascending order. For example, in a single-ended, 8-port network:
 - Ports 1 and 2 become differential-mode pair 1.
 - Ports 3 and 4 become differential-mode pair 2.
 - Ports 5 and 6 become differential-mode pair 3.
 - Ports 7 and 8 become differential-mode pair 4.

The following figure illustrates this convention for an 8-port device.

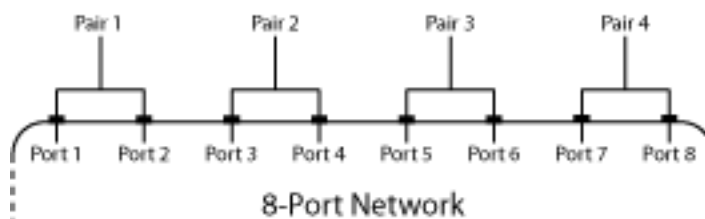

- 3 — s2sdd pairs the input ports in ascending order and the output ports in descending order. For example, in a single-ended, 8-port network:
 - Ports 1 and 2 become differential-mode pair 1.
 - Ports 3 and 4 become differential-mode pair 2.
 - Ports 8 and 7 become differential-mode pair 3.
 - Ports 6 and 5 become differential-mode pair 4.

The following figure illustrates this convention for an 8-port device.

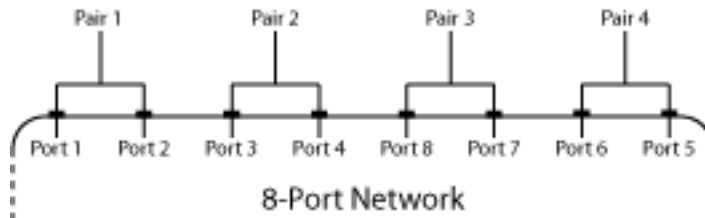

Examples

Convert network data to differential-mode S-parameters using the default port ordering:

```
ckt = read(rfckt.passive, 'default.s4p');
s4p = ckt.NetworkData.Data;
s_dd = s2sdd(s4p);
```

Read a data file, transform the data into differential-mode S-parameters, analyze the new data, and write the new data to a file:

```
% Create a circuit object from a data file
ckt = read(rfckt.passive, 'default.s4p');
data = ckt.AnalyzedResult;
% Create a data object to store the
% differential S-parameters
diffSparams = rfdata.network;
diffSparams.Freq = data.Freq;
diffSparams.Data = s2sdd(data.S_Parameters);
diffSparams.Z0 = 2*data.Z0;
% Create a new circuit object with the data
% from the data object
diffCkt = rfckt.passive;
diffCkt.NetworkData = diffSparams;
% Analyze the new circuit object
frequencyRange = diffCkt.NetworkData.Freq;
ZL = 50;
ZS = 50;
Z0 = diffSparams.Z0;
analyze(diffCkt, frequencyRange, ZL, ZS, Z0);
diffData = diffCkt.AnalyzedResult;
% Write the differential S-parameters into a
% Touchstone data file
```



```
write(diffCkt, 'diffsparams.s2p');
```

References

Fan, W., A. C. W. Lu, L. L. Wai, and B. K. Lok. "Mixed-Mode S-Parameter Characterization of Differential Structures." *Electronic Packaging Technology Conference*, pp. 533–537, 2003.

See Also

s2scc | s2scd | s2sdc | s2smm | smm2s

s2smm

Convert single-ended S-parameters to mixed-mode S-parameters

Syntax

```
[s_dd,s_dc,s_cd,s_cc] = s2smm(s_params_even)
s_mm = s2smm(s_params_odd,option)
```

Description

`[s_dd,s_dc,s_cd,s_cc] = s2smm(s_params_even)` converts the $2N$ -port, single-ended S-parameters `s_params_even` into N -port, mixed-mode S-parameters. `s2smm` forms the mixed-mode ports by grouping the single-ended ports in pairs by port number (index), grouping odd-numbered ports first, followed by even-numbered ports.

`s_mm = s2smm(s_params_odd,option)` converts the S-parameter data according the port-numbering convention specified by `option`. You can also reorder the ports in `s_params` using the `snp2smp` function.

Input Arguments

s_params_even — S-parameters

array

S-parameters, specified as a complex $2N$ -by- $2N$ -by- K array, representing K single-ended, $2N$ -port S-parameters. These parameters describe a device with an even number of ports.

option — Port order

1 (default) | 2 | 3

Port order, specified as 1, 2, 3, determines how the function orders the ports:

- 1 — `s2smm` pairs the odd-numbered ports together first, followed by the even-numbered ports. For example, in a single-ended, 8-port network:
 - Ports 1 and 3 become mixed-mode pair 1.
 - Ports 5 and 7 become mixed-mode pair 2.

- Ports 2 and 4 become mixed-mode pair 3.
- Ports 6 and 8 become mixed-mode pair 4.

The following figure illustrates this convention for an 8-port device.

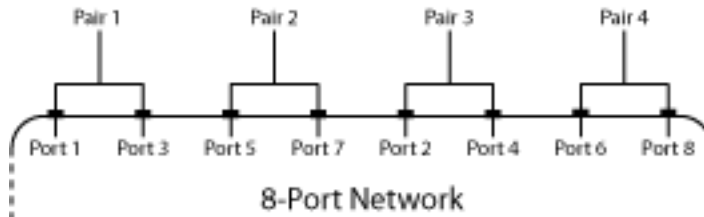

- 2 — s2smm pairs the input and output ports in ascending order. For example, in a single-ended, 8-port network:
 - Ports 1 and 2 become mixed-mode pair 1.
 - Ports 3 and 4 become mixed-mode pair 2.
 - Ports 5 and 6 become mixed-mode pair 3.
 - Ports 7 and 8 become mixed-mode pair 4.

The following figure illustrates this convention for an 8-port device.

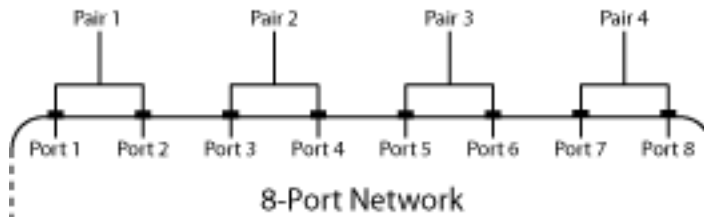

- 3 — s2smm pairs the input ports in ascending order and the output ports in descending order. For example, in a single-ended, 8-port network:
 - Ports 1 and 2 become mixed-mode pair 1.
 - Ports 3 and 4 become mixed-mode pair 2.
 - Ports 8 and 7 become mixed-mode pair 3.
 - Ports 6 and 5 become mixed-mode pair 4.

The following figure illustrates this convention for an 8-port device.

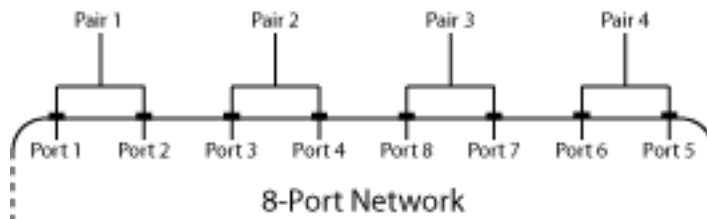

s_params_odd — S-parameters

array

`s_params_odd` is a complex $(2N + 1)$ -by- $(2N + 1)$ -by- K array representing K single-ended, $2N$ -port S-parameters. These parameters describe a device with an odd number of ports.

The port-ordering argument `option` is not available for $(2N + 1)$ -by- $(2N + 1)$ -by- K input arrays. In this case, the ports are always paired in ascending order, and the last port remains single-ended. For example, in a 7-port network:

- Ports 1 and 2 become mixed-mode pair 1.
- Ports 3 and 4 become mixed-mode pair 2.
- Ports 5 and 6 become mixed-mode pair 3.
- Ports 7 remains single ended.

The following figure illustrates this convention for a 7-port device.

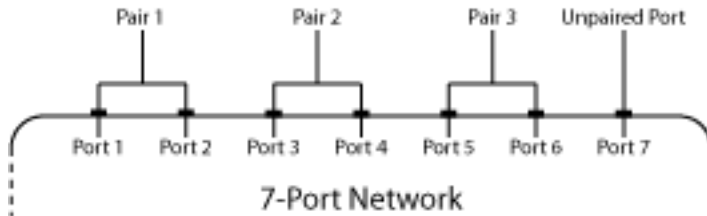

Output Arguments

s_dd — S-parameters

array

S-parameters, returned as complex N -by- N -by- K array, containing K matrices of differential-mode, $2N$ -port S-parameters (S_{dd}).

s_dc — S-parameters

array

S-parameters, returned as a complex N -by- N -by- K array, containing K matrices of cross-mode, N -port S-parameters (S_{dc}).

s_cd — S-parameters

array

S-parameters, returned as a complex N -by- N -by- K array containing K matrices of cross-mode, N -port S-parameters (S_{cd}).

s_cc — S-parameters

array

S-parameters, returned as a complex N -by- N -by- K array containing K matrices of common-mode, N -port S-parameters (S_{cc}).

s_mm — S-parameters

array

Sparameters, returned as a complex $(2N + 1)$ -by- $(2N + 1)$ -by- K array containing K matrices of mixed-mode S-parameters. The parameters are organized in the matrix as follows:

$$\begin{bmatrix} S_{dd,11} & \cdots & S_{dd,1N} & S_{dc,11} & \cdots & S_{dc,1N} & S_{ds,1} \\ \vdots & \ddots & \vdots & \vdots & \ddots & \vdots & \vdots \\ S_{dd,N1} & \cdots & S_{dd,NN} & S_{dc,N1} & \cdots & S_{dc,NN} & S_{ds,N} \\ S_{cd,11} & \cdots & S_{cd,1N} & S_{cc,11} & \cdots & S_{cc,1N} & S_{cs,1} \\ \vdots & \ddots & \vdots & \vdots & \ddots & \vdots & \vdots \\ S_{cd,N1} & \cdots & S_{cd,NN} & S_{cc,N1} & \cdots & S_{cc,NN} & S_{cs,N} \\ S_{sd,1} & \cdots & S_{sd,N} & S_{sc,1} & \cdots & S_{sc,N} & S_{ss} \end{bmatrix}$$

Examples

Convert 4-port S-parameters to 2-port, mixed-mode S-parameters:

```
ckt = read(rfckt.passive,'default.s4p');  
s4p = ckt.NetworkData.Data;  
[s_dd,s_dc,s_cd,s_cc] = s2smm(s4p);
```

References

Granberg, T., *Handbook of Digital Techniques for High-Speed Design*. Upper Saddle River, NJ: Prentice Hall, 2004.

See Also

s2scc | s2scd | s2sdc | s2sdd | smm2s | snp2smp

s2t

Convert S-parameters to T-parameters

Syntax

```
t_params = s2t(s_params)
```

Description

`t_params = s2t(s_params)` converts the scattering parameters `s_params` into the chain scattering parameters `t_params`. The `s_params` input is a complex 2-by-2-by- M array, representing M 2-port S-parameters. `t_params` is a complex 2-by-2-by- M array, representing M 2-port T-parameters.

This function uses the following definition for T-parameters:

$$\begin{bmatrix} a_1 \\ b_1 \end{bmatrix} = \begin{bmatrix} T_{11} & T_{12} \\ T_{21} & T_{22} \end{bmatrix} \begin{bmatrix} b_2 \\ a_2 \end{bmatrix},$$

where:

- a_1 is the incident wave at the first port.
- b_1 is the reflected wave at the first port.
- a_2 is the incident wave at the second port.
- b_2 is the reflected wave at the second port.

Examples

Convert S-parameters to T-parameters:

```
%Define a matrix of S-parameters
s11 = 0.61*exp(j*165/180*pi);
s21 = 3.72*exp(j*59/180*pi);
```

```
s12 = 0.05*exp(j*42/180*pi);  
s22 = 0.45*exp(j*(-48/180)*pi);  
s_params = [s11 s12; s21 s22];  
%Convert to T-parameters  
t_params = s2t(s_params)
```

References

Gonzalez, Guillermo, *Microwave Transistor Amplifiers: Analysis and Design*, 2nd edition. Prentice-Hall, 1997, p. 25.

See Also

s2abcd | s2h | s2y | s2z | t2s

s2tf

Convert S-parameters of 2-port network to voltage or power-wave transfer function

Syntax

```
tf = s2tf(s_params)
tf = s2tf(s_params, z0, zs, z1)
tf = s2tf(s_params, z0, zs, z1, option)

tf = s2tf(hs)
tf = s2tf(hs, zs, z1)
tf = s2tf(hs, zs, z1, option)
```

Description

`tf = s2tf(s_params)` converts the scattering parameters, `s_params`, of a 2-port network into the voltage transfer function of the network.

`tf = s2tf(s_params, z0, zs, z1)` calculates the voltage transfer function using the reference impedance `z0`, source impedance `zs`, and load impedance `z1`.

`tf = s2tf(s_params, z0, zs, z1, option)` calculates the voltage or power-wave transfer function using the method specified by `option`.

`tf = s2tf(hs)` converts the 2-port S-parameter object, `hs`, into the voltage transfer function of the network.

`tf = s2tf(hs, zs, z1)` calculates the voltage transfer function using the source impedance `zs`, and load impedance `z1`.

`tf = s2tf(hs, zs, z1, option)` calculates the voltage or power-wave transfer function using the method specified by `option`.

Input Arguments

hs — 2-port s-parameters
s-parameter object

2-port S-parameters, specified as an RF Toolbox S-parameter object.

s_params — Scattering parameters

2x2xM array (default)

Scattering parameters, specified as a complex 2-by-2-by-*M* array.

z0 — Reference impedance

50 ohms (default)

Reference impedance of S-parameters, specified in ohms.

zs — Source impedance

50 ohms (default)

Source impedance of S-parameters, specified in ohms.

z1 — Load impedance

50 ohms (default)

Load impedance of S-parameters, specified in ohms.

option — Transfer function type

1 (default) | integer

Transfer function type, specified as an integer equal to 1, 2, or 3.

- 1 — The transfer function is the gain from the incident voltage, V_a , to the output voltage for arbitrary source and load impedances:

$$tf = \frac{V_l}{V_a}$$

The following figure shows how to compute V_a from the source voltage V_s :

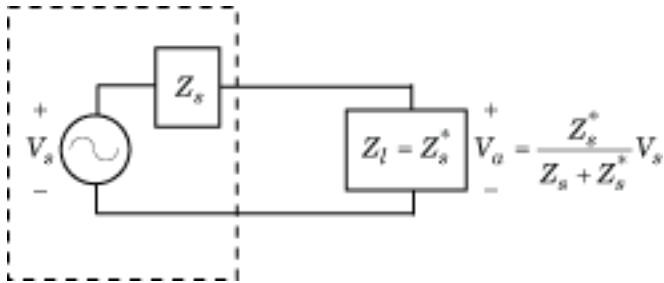

For the S-parameters and impedance values, the transfer function is:

$$tf = \frac{(Z_s + Z_s^*)}{Z_s^*} \frac{S_{21}(1 + \Gamma_l)(1 - \Gamma_s)}{2(1 - S_{22}\Gamma_l)(1 - \Gamma_{in}\Gamma_s)}$$

where:

$$\Gamma_l = \frac{Z_l - Z_o}{Z_l + Z_o}$$

$$\Gamma_s = \frac{Z_s - Z_o}{Z_s + Z_o}$$

$$\Gamma_{in} = S_{11} + \left(S_{12}S_{21} \frac{\Gamma_l}{(1 - S_{22}\Gamma_l)} \right)$$

The following equation shows how the preceding transfer function is related to the transducer gain computed by the powergain function:

$$G_T = |tf|^2 \frac{\operatorname{Re}(Z_l)}{|Z_l|^2} \frac{|Z_s|^2}{\operatorname{Re}(Z_s)}$$

Notice that if \$Z_l\$ and \$Z_s\$ are real, \$G_T = |tf|^2 \frac{Z_s}{Z_l}\$.

- 2 — The transfer function is the gain from the source voltage to the output voltage for arbitrary source and load impedances: 8-93

$$tf = \frac{V_l}{V_s} = \frac{S_{21}(1+\Gamma_l)(1-\Gamma_s)}{2(1-S_{22}\Gamma_l)(1-\Gamma_{in}\Gamma_s)}$$

You can use this option to compute the transfer function $\frac{V_l}{V_{in}}$ by setting `zs` to 0. This setting means that $\Gamma_s = -1$ and $V_{in} = V_s$.

- **3** — The transfer function is the power-wave gain from the incident power wave at the first port to the transmitted power wave at the second port:

$$tf = \frac{b_{p2}}{a_{p1}} = \frac{\sqrt{\text{Re}(Z_l)\text{Re}(Z_s)}}{Z_l} \frac{S_{21}(1+\Gamma_l)(1-\Gamma_s)}{(1-S_{22}\Gamma_l)(1-\Gamma_{in}\Gamma_s)}$$

Output Arguments

tf — Voltage transfer function

vector of doubles

Voltage transfer function, returned as a vector of doubles.

Complex Number Support: Yes

Examples

Calculate the voltage transfer function of an S-parameter array:

```
ckt = read(rfckt.passive, 'passive.s2p');  
sparams = ckt.NetworkData.Data;  
tf = s2tf(sparams)
```

More About

Algorithms

The following figure shows the setup for computing the transfer function, along with the impedences, voltages, and the power waves used to determine the gain.

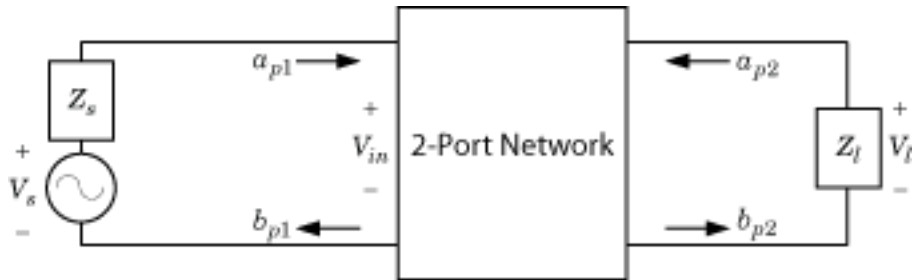

The function uses the following voltages and power waves for calculations:

- V_l is the output voltage across the load impedance.
- V_s is the source voltage.
- V_{in} is the input voltage of the 2-port network.
- a_{p1} is the incident power wave, equal to $\frac{V_s}{2\sqrt{\text{Re}(Z_s)}}$.
- b_{p2} is the transmitted power wave, equal to $\frac{\sqrt{\text{Re}(Z_l)}}{Z_l} V_l$.

See Also

powergain | rationalfit | s2scc | s2scd | s2sdc | s2sdd | snp2smp

s2y

Convert S-parameters to Y-parameters

Syntax

```
y_params = s2y(s_params, z0)
```

Description

`y_params = s2y(s_params, z0)` converts the scattering parameters `s_params` into the admittance parameters `y_params`. The `s_params` input is a complex N -by- N -by- M array, representing M N -port S-parameters. `z0` is the reference impedance; its default is 50 ohms. `y_params` is a complex N -by- N -by- M array, representing M N -port Y-parameters.

Alternatives

You can also use network parameter objects to perform network parameter conversions. For more information, see “RF Network Parameter Objects” on page 2-11.

Examples

Convert S-parameters to Y-parameters:

```
%Define a matrix of S-parameters
s_11 = 0.61*exp(j*165/180*pi);
s_21 = 3.72*exp(j*59/180*pi);
s_12 = 0.05*exp(j*42/180*pi);
s_22 = 0.45*exp(j*(-48/180)*pi);
s_params = [s_11 s_12; s_21 s_22];
z0 = 50;
%Convert to Y-parameters
y_params = s2y(s_params, z0)
```

See Also

abcd2y | h2y | s2abcd | s2h | s2z | y2s | z2y

s2z

Convert S-parameters to Z-parameters

Syntax

```
z_params = s2z(s_params, z0)
```

Description

`z_params = s2z(s_params, z0)` converts the scattering parameters `s_params` into the impedance parameters `z_params`. The `s_params` input is a complex N -by- N -by- M array, representing M N -port S-parameters. `z0` is the reference impedance; its default is 50 ohms. `z_params` is a complex N -by- N -by- M array, representing M N -port Z-parameters.

Alternatives

You can also use network parameter objects to perform network parameter conversions. For more information, see “RF Network Parameter Objects” on page 2-11.

Examples

Convert S-parameters to Z-parameters:

```
%Define a matrix of S-parameters
s_11 = 0.61*exp(j*165/180*pi);
s_21 = 3.72*exp(j*59/180*pi);
s_12 = 0.05*exp(j*42/180*pi);
s_22 = 0.45*exp(j*(-48/180)*pi);
s_params = [s_11 s_12; s_21 s_22];
z0 = 50;
%Convert to Z-parameters
z_params = s2z(s_params, z0)
```

See Also

abcd2z | h2z | s2abcd | s2h | s2y | y2z | z2s

smithchart

Plot complex vector of a reflection coefficient on Smith chart

Syntax

```
[lineseries,hsm] = smithchart(gamma)
```

```
hsm = smithchart
```

Description

`[lineseries,hsm] = smithchart(gamma)` plots the complex vector of a reflection coefficient `gamma` on a Smith chart. `hsm` is the handle of the Smith chart object. `lineseries` is a column vector of handles to `lineseries` objects, one handle per plotted line.

To plot network parameters from a circuit (`rfckt`) or data (`rfddata`) object on a Smith chart, use the `smith` function.

`hsm = smithchart` draws a blank Smith chart and returns the handle, `hsm`, of the Smith chart object.

Input arguments

gamma — reflection coefficient

complex vector

Reflection coefficient, specified as a complex vector.

Data Types: double

Complex Number Support: Yes

Output Arguments

lineseries — line properties handle

column vector

Line properties handle, returned as a column vector, changes the properties of the plotted lines by changing the Chart Line Properties. There is one handle per plotted line.

hsm — Smith chart handle

scalar handle

Smith chart handle, specified as a scalar handle.

This table lists all properties you can specify for `smithchart` objects along with units, valid values, and descriptions of their use.

Property Name	Description	Units and Values
Color	Line color for a Z or Y Smith chart. For a ZY Smith chart, the Z line color.	ColorSpec. Default is [0.4 0.4 0.4] (dark gray).
LabelColor	Color of the line labels.	ColorSpec. Default is [0 0 0] (black).
LabelSize	Size of the line labels.	FontSize. Default is 10. See the Annotation Text Box Properties reference page for more information on specifying font size.
LabelVisible	Visibility of the line labels.	'on' (default) or 'off'
LineType	Line spec for a Z or Y Smith chart. For a ZY Smith chart, the Z line spec.	LineStyle. Default is '-' (solid line).
LineWidth	Line width for a Z or Y Smith chart. For a ZY Smith chart, the Z line width.	Number of points. Default is 0.5.
SubColor	The Y line color for a ZY Smith chart.	ColorSpec. Default is [0.8 0.8 0.8] (medium gray).
SubLineType	The Y line spec for a ZY Smith chart.	LineStyle. Default is ':' (dotted line).
SubLineWidth	The Y line width for a ZY Smith chart.	Number of points. Default is 0.5.

Property Name	Description	Units and Values
Type	Type of Smith chart.	'z' (default), 'y', or 'zy'
Value	Two-row matrix. Row 1 specifies the values of the constant resistance and reactance lines in the chart. For the constant resistance and reactance lines, each element in Row 2 specifies the value at which the corresponding line in Row 1 ends.	2-by-n matrix. Default is [0.2000 0.5000 1.0000 2.0000 5.0000; 1.0000 2.0000 5.0000 5.0000 30.0000]

Examples

Plot Reflection Data On a Smith Chart

```
S = sparameters('passive.s2p');
s11 = rfparam(S,1,1);
figure
smithchart(s11)
```

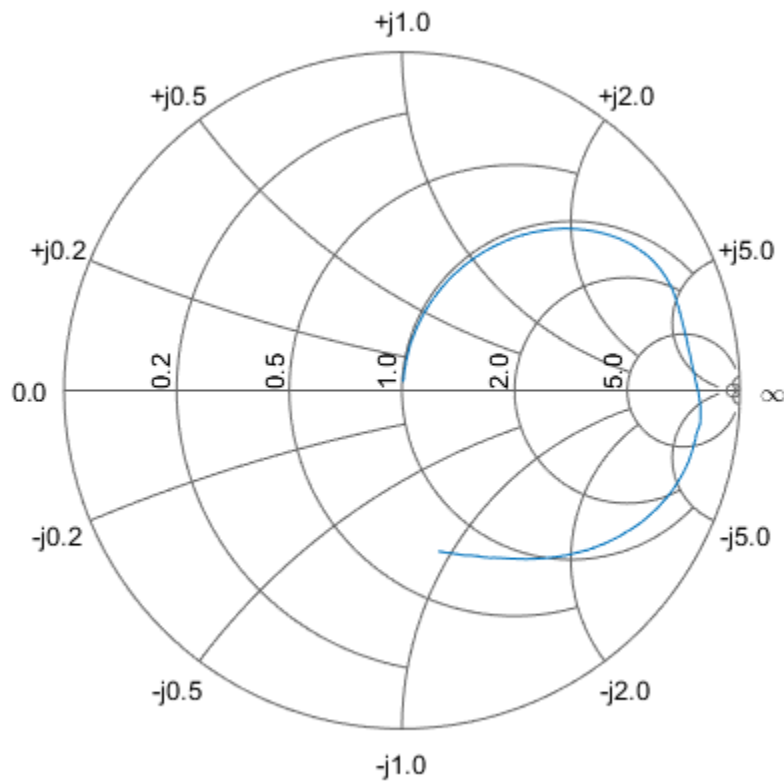

Plot Impedance Data On a Smith Chart

```
z = 0.1*50 + 1j*(0:0.1:50);  
gamma = z2gamma(z);  
figure  
smithchart(gamma)
```

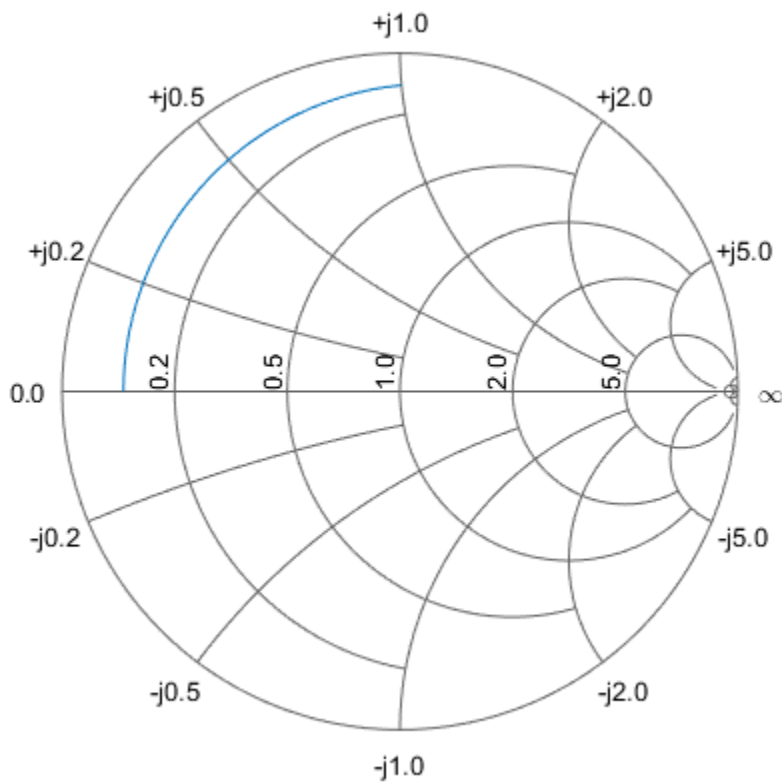

Draw a Blank Smithchart

```
hsm = smithchart
```

```
hsm =
```

```
rfchart.smith with properties:
```

```

    Type: 'Z'
    Values: [2x5 double]
    Color: [0.4000 0.4000 0.4000]
    LineWidth: 0.5000
    LineType: '-'

```

```
SubColor: [0.8000 0.8000 0.8000]  
SubLineWidth: 0.5000  
SubLineType: ':'  
LabelVisible: 'On'  
LabelSize: 10  
LabelColor: [0 0 0]  
Name: 'Smith chart'
```

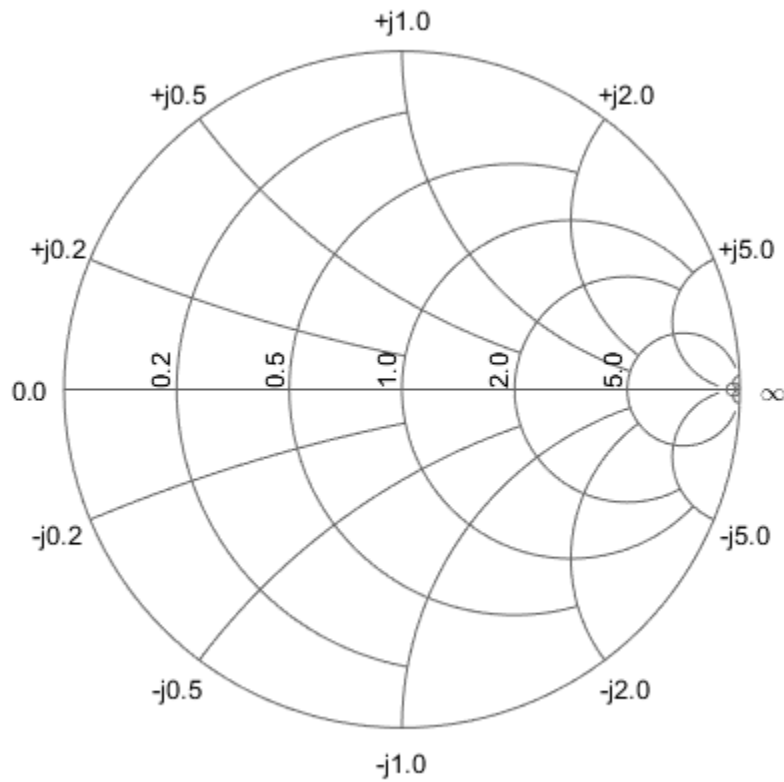

See Also

get | set | smith

smm2s

Convert mixed-mode 2N-port S-parameters to single-ended 4N-port S-parameters

Syntax

```
s_params = smm2s(s_dd,s_dc,s_cd,s_cc)
s_params = smm2s(s_dd,s_dc,s_cd,s_cc,option)
```

Description

`s_params = smm2s(s_dd,s_dc,s_cd,s_cc)` converts mixed-mode, N -port S-parameters into single-ended, $2N$ -port S-parameters, `s_params`. `smm2s` maps the first half of the mixed-mode ports to the odd-numbered pairs of single-ended ports and maps the second half to the even-numbered pairs.

`s_params = smm2s(s_dd,s_dc,s_cd,s_cc,option)` converts the S-parameter data using the optional argument `option`. You can also reorder the ports in `s_params` using the `snp2smp` function.

Input Arguments

s_cc — S-parameters

array

S-parameters, specified as a complex N -by- N -by- K array containing K matrices of common-mode, N -port S-parameters (S_{cc}).

s_cd — S-parameters

array

S-parameters, specified as a complex N -by- N -by- K array containing K matrices of cross-mode, N -port S-parameters (S_{cd}).

s_dc — S-parameters

array

S-parameters, specified as a complex N -by- N -by- K array containing K matrices of cross-mode, N -port S-parameters (S_{dc}).

s_dd — S-parameters

array

S-parameters, specified as a complex N -by- N -by- K array containing K matrices of differential-mode, N -port S-parameters (S_{dd}).

option — Port order

1 (default) | 2 | 3

Port order, specified as 1, 2, 3 determines how the function orders the ports:

- 1 — `smm2s` maps the first half of the mixed-mode pairs to odd-numbered pairs of single-ended ports and maps the second half to even-numbered pairs. For example, in a mixed-mode, 4-port network:
 - Port 1 becomes single-ended ports 1 and 3.
 - Port 2 becomes single-ended ports 5 and 7.
 - Port 3 becomes single-ended ports 2 and 4.
 - Port 4 becomes single-ended ports 6 and 8.

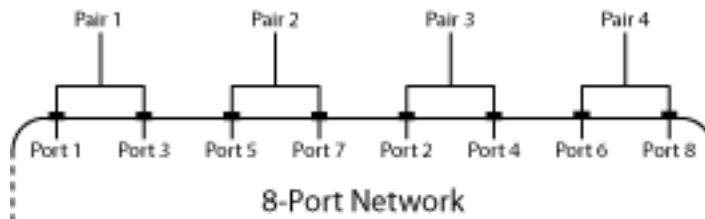

- 2 — `smm2s` maps the first half of the mixed-mode pairs to single-ended ports in ascending numerical order, followed by the second half, also in ascending order. For example, in a mixed-mode, 4-port network:
 - Port 1 becomes single-ended ports 1 and 2.
 - Port 2 becomes single-ended ports 3 and 4.
 - Port 3 becomes single-ended ports 5 and 6.
 - Port 4 becomes single-ended ports 7 and 8.

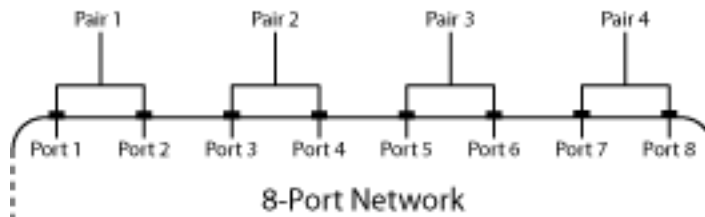

- 3 — `smm2s` maps the first half of the mixed-mode pairs to single-ended ports in ascending numerical order. The function maps the second half to pairs of ports in descending order. For example, in a mixed-mode, 4-port network:
 - Port 1 becomes single-ended ports 1 and 2.
 - Port 2 becomes single-ended ports 3 and 4.
 - Port 3 becomes single-ended ports 8 and 7.
 - Port 4 becomes single-ended ports 6 and 5.

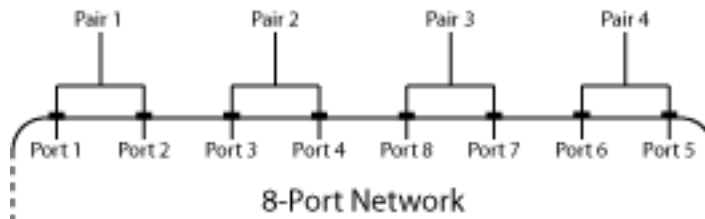

Output Arguments

`s_params` — S-parameters

array

S-parameters, returned as a complex $2N$ -by- $2N$ -by- K array representing K single-ended, $2N$ -port S-parameters.

Examples

Convert between mixed-mode and single-ended S-parameters:

```
% Create mixed-mode S-parameters:
```

```
ckt = read(rfckt.passive,'default.s4p');  
s4p = ckt.NetworkData.Data;  
[sdd,scd,scd,scd] = s2smm(s4p);  
% Convert them back to 4-port,single-ended S-parameters:  
s4p_converted_back = smm2s(sdd,scd,scd,scd);
```

References

Granberg, T., *Handbook of Digital Techniques for High-Speed Design*. Upper Saddle River, NJ: Prentice Hall, 2004.

See Also

s2scc | s2scd | s2sdc | s2sdd | s2smm | snp2smp

snp2smp

Convert and reorder single-ended N-port S-parameters to single-ended M-port S-parameters

Syntax

```
s_params_mp = snp2smp(s_params_np)
s_params_mp = snp2smp(s_params_np, Z0, n2m_index, ZT)
```

Description

`s_params_mp = snp2smp(s_params_np)` convert and reorder the single-ended N-port S-parameters, `s_params_np`, into the single-ended M-port S-parameters, `s_params_mp`. *M* must be less than or equal to *N*.

`s_params_mp = snp2smp(s_params_np, Z0, n2m_index, ZT)` convert and reorder the S-parameter data using the optional arguments `Z0`, `n2m_index`, and `ZT` that control the conversion.

The following figure illustrates how to use the optional input arguments to specify the ports for the output data and the termination of the remaining ports.

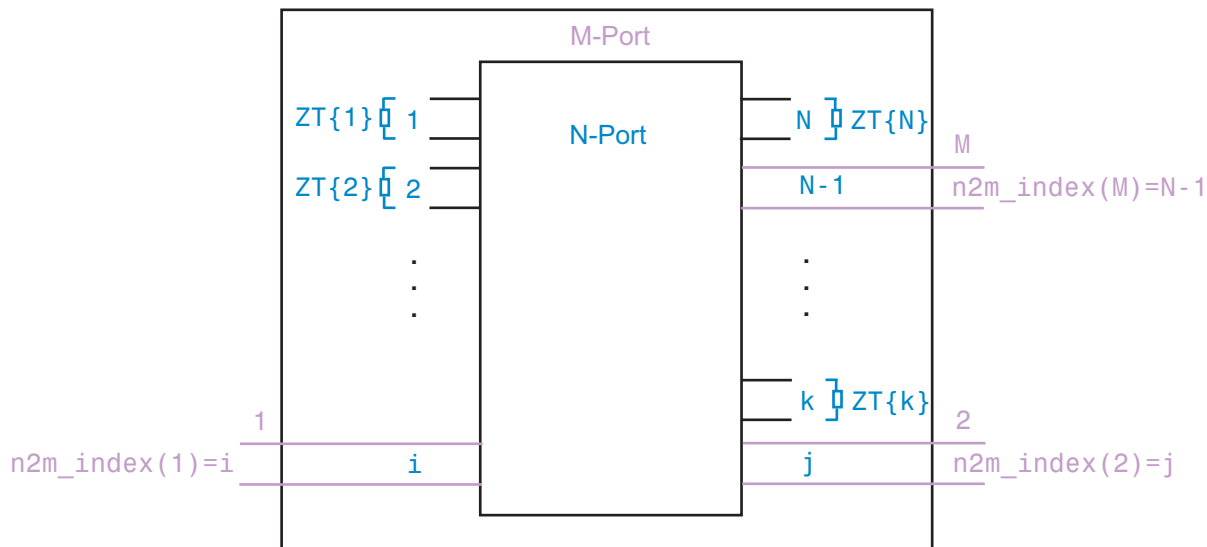

Input Arguments

s_params_np

s_params_np is a complex N -by- N -by- K array representing K N -port S-parameters.

Z0 — Reference Impedance

50 (default) | scalar

Reference impedance in ohms, specified as a scalar, of the resulting S-parameters.

n2m_index — Mapping index

[1, 2] (default)

n2m_index is a vector of length M specifying how the ports of the N -port S-parameters map to the ports of the M -port S-parameters. n2m_index(i) is the index of the port from s_params_np that the function converts to the i th port of s_params_mp. For example, the setting [1, 2] means that M is 2, and the first two ports of the N -port S-parameters become the ports of the M -port parameters. The function terminates any additional ports with the impedances specified by ZT.

ZT

ZT is a scalar, vector, or cell array specifying the termination impedance of the ports. If M is less than N , `snp2smp` terminates the $N-M$ ports not listed in `n2m_index` using the values in ZT. If ZT is a scalar, the function terminates all $N-M$ ports not listed in `n2m_index` by the same impedance ZT. If ZT is a vector of length K , `ZT[i]` is the impedance that terminates all $N-M$ ports of the i th frequency point not listed in `n2m_index`. If ZT is a cell array of length N , `ZT{j}` is the impedance that terminates the j th port of the N -port S-parameters. The function ignores impedances related to the ports listed in `n2m_index`. Each `ZT{j}` can be a scalar or a vector of length K .

The following figure illustrates how to use the optional input arguments to specify the ports for the output data and the termination of the remaining ports.

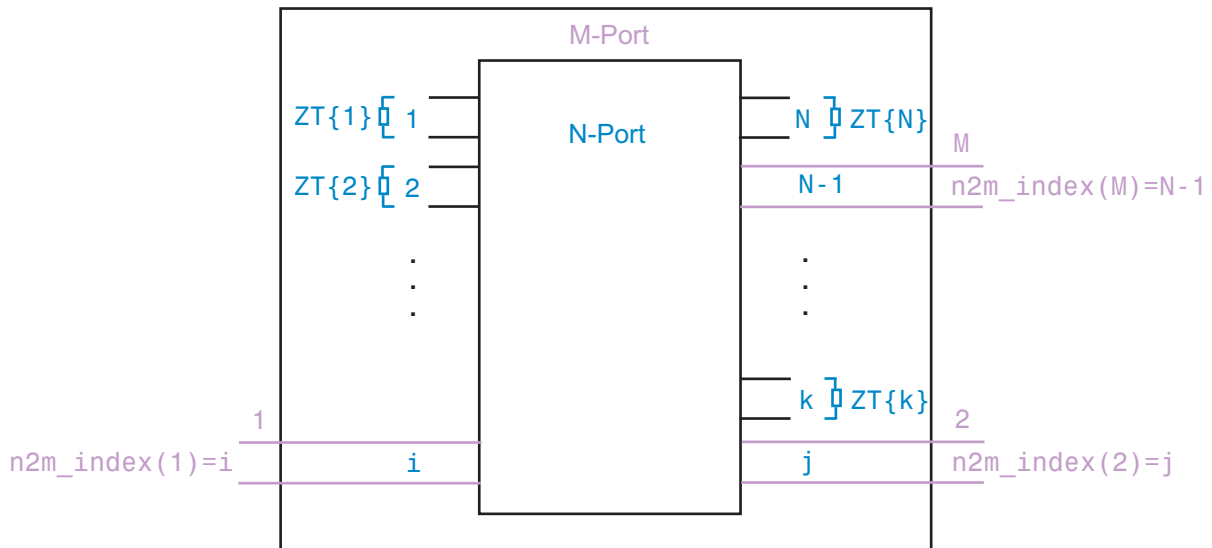
**Examples**

Convert 3-port S-parameters to 3-port S-parameters with port indices swapped from [1 2 3] to [2 3 1]:

```
ckt = read(rfckt.passive,'default.s3p');
%default.s3p represents a real counterclockwise circulator
```

```
s3p = ckt.NetworkData.Data;  
Z0 = ckt.NetworkData.Z0;  
s3p_new = snp2smp(s3p,Z0,[2 3 1])
```

Convert 3-port S-parameters to 2-port S-parameters by terminating port 3 with an impedance of Z0:

```
ckt = read(rfckt.passive,'default.s3p');  
s3p = ckt.NetworkData.Data;  
Z0 = ckt.NetworkData.Z0;  
s2p = snp2smp(s3p,Z0);
```

Convert 16-port S-parameters to 4-port S-parameters by using ports 1, 16, 2, and 15 as the first, second, third, and fourth ports; terminate the remaining 12 ports with an impedance of Z0:

```
ckt = read(rfckt.passive,'default.s16p');  
s16p = ckt.NetworkData.Data;  
Z0 = ckt.NetworkData.Z0;  
s4p = snp2smp(s16p,Z0,[1 16 2 15],Z0)
```

Convert 16-port S-parameters to 4-port S-parameters by using ports 1, 16, 2, and 15 as the first, second, third, and fourth ports; terminate port 4 with an impedance of 100 ohms and terminate the remaining 11 ports with an impedance of 50 ohms:

```
ckt = read(rfckt.passive,'default.s16p');  
s16p = ckt.NetworkData.Data;  
Z0 = ckt.NetworkData.Z0;  
ZT = {};  
ZT(1:16) = {50};  
ZT{4} = 100;  
s4p = snp2smp(s16p,Z0,[1 16 2 15],ZT)
```

See Also

freqresp | rfmodel.rational | s2tf | timeresp | writeeva

stabilityk

Stability factor K of 2-port network

Syntax

```
[k,b1,b2,delta] = stabilityk(s_params)
[k,b1,b2,delta] = stabilityk(hs)
```

Description

`[k,b1,b2,delta] = stabilityk(s_params)` calculates and returns the stability factor, k , and the conditions $b1$, $b2$, and δ for the 2-port network. The input `s_params` is a complex 2-by-2-by- M array, representing M 2-port S-parameters.

`[k,b1,b2,delta] = stabilityk(hs)` calculates and returns the stability factor and stability conditions for the 2-port network represented by the S-parameter object `hs`.

Examples

Examine the stability of network data from a file:

```
% Calculate stability factor and conditions
ckt = read(rfckt.passive,'passive.s2p');
s_params = ckt.NetworkData.Data;
freq = ckt.NetworkData.Freq;
[k b1 b2 delta] = stabilityk(s_params);
% Check stability criteria
stability_index = (k>1)&(abs(delta)<1);
is_stable = all(stability_index)
% List frequencies with unstable S-parameters
freq_unstable = freq(~stability_index);
```

More About

Algorithms

Necessary and sufficient conditions for stability are $k > 1$ and $\text{abs}(\Delta) < 1$. `stabilityk` calculates the outputs using the equations

$$K = \frac{1 - |S_{11}|^2 - |S_{22}|^2 + |\Delta|^2}{2|S_{12}S_{21}|}$$

$$B_1 = 1 + |S_{11}|^2 - |S_{22}|^2 - |\Delta|^2$$

$$B_2 = 1 - |S_{11}|^2 + |S_{22}|^2 - |\Delta|^2$$

where:

- S_{11} , S_{12} , S_{21} , and S_{22} are S-parameters from the input argument `s_params`.
- Δ is a vector whose members are the determinants of the M 2-port S-parameter matrices:

$$\Delta = S_{11}S_{22} - S_{12}S_{21}$$

The function performs these calculations element-wise for each of the M S-parameter matrices in `s_params`.

References

Gonzalez, Guillermo, *Microwave Transistor Amplifiers: Analysis and Design*, 2nd edition. Prentice-Hall, 1997, pp. 217–228.

See Also

`gammaml` | `gammams` | `stabilitymu`

stabilitymu

Stability factor μ of 2-port network

Syntax

```
[mu,muprime] = stabilitymu(s_params)
```

Description

`[mu,muprime] = stabilitymu(s_params)` calculates and returns the stability factors μ and μ' of a 2-port network. The input `s_params` is a complex 2-by-2-by- M array, representing M 2-port S-parameters.

`[mu,muprime] = stabilitymu(hs)` calculates and returns the stability factors for the network represented by the S-parameter object `hs`.

The stability factor, μ , defines the minimum distance between the center of the unit Smith chart and the unstable region in the load plane. The function assumes that port 2 is the load.

The stability factor, μ' , defines the minimum distance between the center of the unit Smith chart and the unstable region in the source plane. The function assumes that port 1 is the source.

Having $\mu > 1$ or $\mu' > 1$ is the necessary and sufficient condition for the 2-port linear network to be unconditionally stable, as described by the S-parameters.

Examples

Examine the stability of network data from a file:

```
% Calculate stability factor and conditions
ckt = read(rfckt.passive,'passive.s2p');
s_params = ckt.NetworkData.Data;
freq = ckt.NetworkData.Freq;
[mu muprime] = stabilitymu(s_params);
```

```
% Check stability criteria
stability_index = (mu>1)|(muprime>1);
is_stable = all(stability_index)
% List frequencies with unstable S-parameters
freq_unstable = freq(~stability_index);
```

More About

Algorithms

stabilitymu calculates the stability factors using the equations

$$\mu = \frac{1 - |S_{11}|^2}{|S_{22} - S_{11}^* \Delta| + |S_{21} S_{12}|}$$

$$\mu' = \frac{1 - |S_{22}|^2}{|S_{11} - S_{22}^* \Delta| + |S_{21} S_{12}|}$$

where:

- S_{11} , S_{12} , S_{21} , and S_{22} are S-parameters, from the input argument `s_params`.
- Δ is a vector whose members are the determinants of the M 2-port S-parameter matrices:

$$\Delta = S_{11} S_{22} - S_{12} S_{21}$$

- S^* is the complex conjugate of the corresponding S-parameter.

The function performs these calculations element-wise for each of the M S-parameter matrices in `s_params`.

References

Edwards, Marion Lee, and Jeffrey H. Sinsky, "A New Criterion for Linear 2-Port Stability Using a Single Geometrically Derived Parameter," *IEEE Transactions on Microwave Theory and Techniques*, Vol. 40, No. 12, pp. 2303-2311, December 1992.

See Also
stabilityk

t2s

Convert T-parameters to S-parameters

Syntax

```
s_params = t2s(t_params)
```

Description

`s_params = t2s(t_params)` converts the chain scattering parameters `t_params` into the scattering parameters `s_params`. The `t_params` input is a complex 2-by-2-by- M array, representing M 2-port T-parameters. `s_params` is a complex 2-by-2-by- M array, representing M 2-port S-parameters.

This function defines the T-parameters as

$$\begin{bmatrix} a_1 \\ b_1 \end{bmatrix} = \begin{bmatrix} T_{11} & T_{12} \\ T_{21} & T_{22} \end{bmatrix} \begin{bmatrix} b_2 \\ a_2 \end{bmatrix},$$

where:

- a_1 is the incident wave at the first port.
- b_1 is the reflected wave at the first port.
- a_2 is the incident wave at the second port.
- b_2 is the reflected wave at the second port.

Examples

Convert T-parameters to S-parameters:

```
%Define a matrix of T-parameters
t11 = 0.138451095405929 - 0.230421317393041i;
t21 = -0.0451985986689165 + 0.157626245839348i;
```

```
t12 = 0.0353675449261375 + 0.115682026931012i;  
t22 = -0.00194567217559662 - 0.0291212122613417i;  
t_params = [t11 t12; t21 t22];  
%Convert to S-parameters  
s_params = t2s(s_params)
```

References

Gonzalez, Guillermo, *Microwave Transistor Amplifiers: Analysis and Design*, 2nd edition. Prentice-Hall, 1997, p. 25.

See Also

abcd2s | h2s | s2t | y2s | z2s

VSWR

VSWR at given reflection coefficient Γ

Syntax

```
ratio = vswr(gamma)
```

Description

`ratio = vswr(gamma)` calculates the voltage standing-wave ratio *VSWR* at the given reflection coefficient Γ as

$$VSWR = \frac{1 + |\Gamma|}{1 - |\Gamma|}$$

The input `gamma` is a complex vector. The output `ratio` is a real vector of the same length as `gamma`.

Examples

Calculate the VSWR for a given reflection coefficient:

```
gamma = 1/3;  
ratio = vswr(gamma)
```

See Also

```
gamma2z | gammain | gammaout
```

y2abcd

Convert Y-parameters to ABCD-parameters

Syntax

```
abcd_params = y2abcd(y_params)
```

Description

`abcd_params = y2abcd(y_params)` converts the admittance parameters `y_params` into the ABCD-parameters `abcd_params`. The `y_params` input is a complex $2N$ -by- $2N$ -by- M array, representing M $2N$ -port Y-parameters. `abcd_params` is a complex $2N$ -by- $2N$ -by- M array, representing M $2N$ -port ABCD-parameters. The output ABCD-parameter matrices have distinct A , B , C , and D submatrices:

$$\begin{bmatrix} [A] & [B] \\ [C] & [D] \end{bmatrix}$$

Alternatives

You can also use network parameter objects to perform network parameter conversions. For more information, see “RF Network Parameter Objects” on page 2-11.

Examples

Convert Y-parameters to ABCD-parameters:

```
%Define a matrix of Y-parameters.  
Y11 = 0.0488133074245012 - 0.390764155450191i;  
Y12 = -0.0488588365420561 + 0.390719345880018i;  
Y21 = -0.0487261119282660 + 0.390851884427087i;  
Y22 = 0.0487710062903760 - 0.390800401433241i;  
y_params = [Y11,Y12; Y21,Y22];
```



```
%Convert to ABCD-parameters  
abcd_params = y2abcd(y_params);
```

See Also

abcd2y | h2abcd | s2abcd | y2h | y2s | y2z | z2abcd

y2h

Convert Y-parameters to hybrid h-parameters

Syntax

```
h_params = y2h(y_params)
```

Description

`h_params = y2h(y_params)` converts the admittance parameters `y_params` into the hybrid parameters `h_params`. The `y_params` input is a complex 2-by-2-by- M array, representing M 2-port Y-parameters. `h_params` is a complex 2-by-2-by- M array, representing M 2-port hybrid h-parameters.

Alternatives

You can also use network parameter objects to perform network parameter conversions. For more information, see “RF Network Parameter Objects” on page 2-11.

Examples

Convert Y-parameters to h-parameters:

```
%Define a matrix of Y-parameters.  
Y11 = 0.0488133074245012 - 0.390764155450191i;  
Y12 = -0.0488588365420561 + 0.390719345880018i;  
Y21 = -0.0487261119282660 + 0.390851884427087i;  
Y22 = 0.0487710062903760 - 0.390800401433241i;  
y_params = [Y11,Y12; Y21,Y22];  
%Convert to h-parameters  
h_params = y2h(y_params);
```

See Also

abcd2h | h2y | s2h | y2abcd | y2s | y2z | z2h

y2s

Convert Y-parameters to S-parameters

Syntax

```
s_params = y2s(y_params, z0)
```

Description

`s_params = y2s(y_params, z0)` converts the admittance parameters `y_params` into the scattering parameters `s_params`. The `y_params` input is a complex N -by- N -by- M array, representing M N -port Y-parameters. `z0` is the reference impedance. The default value of `z0` is 50 ohms. `s_params` is a complex N -by- N -by- M array, representing M N -port S-parameters.

Alternatives

You can also use network parameter objects to perform network parameter conversions. For more information, see “RF Network Parameter Objects” on page 2-11.

Examples

Convert Y-parameters to S-parameters:

```
%Define a matrix of Y-parameters.
Y11 = 0.0488133074245012 - 0.390764155450191i;
Y12 = -0.0488588365420561 + 0.390719345880018i;
Y21 = -0.0487261119282660 + 0.390851884427087i;
Y22 = 0.0487710062903760 - 0.390800401433241i;
y_params = [Y11,Y12; Y21,Y22];
%Convert to S-parameters
s_params = y2s(y_params);
```

See Also

abcd2s | h2s | s2y | y2abcd | y2h | y2s | y2z | z2s

y2z

Convert Y-parameters to Z-parameters

Syntax

```
z_params = y2z(y_params)
```

Description

`z_params = y2z(y_params)` converts the admittance parameters `y_params` into the impedance parameters `z_params`. The `y_params` input is a complex N -by- N -by- M array, representing M N -port Y-parameters. `z_params` is a complex N -by- N -by- M array, representing M N -port Z-parameters.

Alternatives

You can also use network parameter objects to perform network parameter conversions. For more information, see “RF Network Parameter Objects” on page 2-11.

Examples

Convert Y-parameters to Z-parameters:

```
%Define a matrix of Y-parameters.  
Y11 = 0.0488133074245012 - 0.390764155450191i;  
Y12 = -0.0488588365420561 + 0.390719345880018i;  
Y21 = -0.0487261119282660 + 0.390851884427087i;  
Y22 = 0.0487710062903760 - 0.390800401433241i;  
y_params = [Y11,Y12; Y21,Y22];  
%Convert to Z-parameters  
z_params = y2z(y_params);
```

See Also

abcd2z | h2z | y2abcd | y2h | y2s | y2z | z2s | z2y

z2abcd

Convert Z-parameters to ABCD-parameters

Syntax

```
abcd_params = z2abcd(z_params)
```

Description

`abcd_params = z2abcd(z_params)` converts the impedance parameters `z_params` into the ABCD-parameters `abcd_params`. The `z_params` input is a complex $2N$ -by- $2N$ -by- M array, representing M $2N$ -port Z-parameters. `abcd_params` is a complex $2N$ -by- $2N$ -by- M array, representing M $2N$ -port ABCD-parameters. The output ABCD-parameter matrices have distinct *A*, *B*, *C*, and *D* submatrices:

$$\begin{bmatrix} [A] & [B] \\ [C] & [D] \end{bmatrix}$$

Alternatives

You can also use network parameter objects to perform network parameter conversions. For more information, see “RF Network Parameter Objects” on page 2-11.

Examples

Convert Z-parameters to ABCD-parameters:

```
%Define a matrix of Z-parameters.
Z11 = -14567.2412789287 - 148373.315116592i
Z12 = -14588.1106171651 - 148388.583516562i
Z21 = -14528.0522132692 - 148350.705757767i
Z22 = -14548.5996561832 - 148363.457002006i
z_params = [Z11,Z12; Z21,Z22];
```

```
%Convert to ABCD-parameters  
abcd_params = z2abcd(z_params);
```

See Also

abcd2z | h2abcd | s2abcd | y2abcd | z2h | z2s | z2y

z2gamma

Convert impedance to reflection coefficient

Syntax

```
gamma = z2gamma(z)  
gamma = z2gamma(z, z0)
```

Description

`gamma = z2gamma(z)` converts the impedance `z` to the reflection coefficient `gamma` using a reference impedance of 50 ohms.

`gamma = z2gamma(z, z0)` converts the impedance `z` to the reflection coefficient `gamma` using a reference impedance of `z0` ohms.

Examples

Convert an impedance of 100 ohms into a reflection coefficient, using a 50-ohm reference impedance:

```
z = 100;  
gamma = z2gamma(z)
```

More About

Algorithms

`z2gamma` calculates the coefficient using the equation

$$\Gamma = \frac{Z - Z_0}{Z + Z_0}$$

See Also

gamma2z | gammain | gammaout

z2h

Convert Z-parameters to hybrid h-parameters

Syntax

```
h_params = z2h(z_params)
```

Description

`h_params = z2h(z_params)` converts the impedance parameters `z_params` into the hybrid parameters `h_params`. The `z_params` input is a complex 2-by-2-by- M array, representing M 2-port Z-parameters. `h_params` is a complex 2-by-2-by- M array, representing M 2-port hybrid h-parameters.

Alternatives

You can also use network parameter objects to perform network parameter conversions. For more information, see “RF Network Parameter Objects” on page 2-11.

Examples

Convert Z-parameters to H-parameters:

```
%Define a matrix of Z-parameters.  
Z11 = -14567.2412789287 - 148373.315116592i  
Z12 = -14588.1106171651 - 148388.583516562i  
Z21 = -14528.0522132692 - 148350.705757767i  
Z22 = -14548.5996561832 - 148363.457002006i  
z_params = [Z11,Z12; Z21,Z22];  
%Convert to h-parameters  
h_params = z2h(z_params);
```

See Also

abcd2h | h2z | s2h | y2h | z2abcd | z2s | z2y

z2s

Convert Z-parameters to S-parameters

Syntax

```
s_params = z2s(z_params,z0)
```

Description

`s_params = z2s(z_params,z0)` converts the impedance parameters `z_params` into the scattering parameters `s_params`. The `z_params` input is a complex N -by- N -by- M array, representing M N -port Z-parameters. `z0` is the reference impedance; its default is 50 ohms. `s_params` is a complex N -by- N -by- M array, representing M n -port S-parameters.

Alternatives

You can also use network parameter objects to perform network parameter conversions. For more information, see “RF Network Parameter Objects” on page 2-11.

Examples

Convert Z-parameters to S-parameters:

```
%Define a matrix of Z-parameters.  
Z11 = -14567.2412789287 - 148373.315116592i  
Z12 = -14588.1106171651 - 148388.583516562i  
Z21 = -14528.0522132692 - 148350.705757767i  
Z22 = -14548.5996561832 - 148363.457002006i  
z_params = [Z11,Z12; Z21,Z22];  
%Convert to S-parameters  
s_params = z2s(z_params);
```

See Also

abcd2s | h2s | s2z | y2s | z2abcd | z2h | z2y

z2y

Convert Z-parameters to Y-parameters

Syntax

```
y_params = z2y(z_params)
```

Description

`y_params = z2y(z_params)` converts the impedance parameters `z_params` into the admittance parameters `y_params`. The `z_params` input is a complex N -by- N -by- M array, representing M N -port Z-parameters. `y_params` is a complex N -by- N -by- M array, representing M N -port Y-parameters.

Examples

Convert Z-parameters to Y-parameters:

```
%Define a matrix of Z-parameters.  
Z11 = -14567.2412789287 - 148373.315116592i  
Z12 = -14588.1106171651 - 148388.583516562i  
Z21 = -14528.0522132692 - 148350.705757767i  
Z22 = -14548.5996561832 - 148363.457002006i  
z_params = [Z11,Z12; Z21,Z22];  
%Convert to Y-parameters  
y_params = z2y(z_params);
```

See Also

[abcd2y](#) | [h2y](#) | [s2y](#) | [y2z](#) | [z2abcd](#) | [z2h](#) | [z2s](#)

AMP File Format

AMP File Data Sections

In this section...
“Overview” on page 9-2
“Denoting Comments” on page 9-3
“Data Sections” on page 9-3
“S, Y, or Z Network Parameters” on page 9-3
“Noise Parameters” on page 9-5
“Noise Figure Data” on page 9-6
“Power Data” on page 9-8
“IP3 Data” on page 9-10
“Inconsistent Data Sections” on page 9-11

Overview

The AMP data file describes a single nonlinear device. Its format can contain the following types of data:

- S, Y, or Z network parameters
- Noise parameters
- Noise figure data
- Power data
- IP3 data

An AMP file must contain either power data or network parameter data to be valid. To accommodate analysis at more than one frequency, the file can contain more than one section of power data. Noise data, noise figure data, and IP3 data are optional.

Note: If the file contains both network parameter data and power data, RF Toolbox software checks the data for consistency. If the amplifier gain computed from the network parameters is not consistent with the gain computed from the power data, a warning appears. For more information, see .

Two AMP files, `samplepa1.amp` and `default.amp`, ship with the toolbox to show the AMP format. They describe a nonlinear 2-port amplifier with noise. See “Model a Cascaded RF Network” on page 1-10 for an example that shows how to use an AMP file.

For information on specifying data in an AMP file, see . For information about adding comments to an AMP file, see .

Denoting Comments

An asterisk (*) or an exclamation point (!) precedes a comment that appears on a separate line.

A semicolon (;) precedes a comment that appears following data on the same line.

Data Sections

Each kind of data resides in its own section. Each section consists of a two-line header followed by lines of numeric data. Numeric values can be in any valid MATLAB format.

A new header indicates the end of the previous section. The data sections can appear in any order in the file.

Note: In the data section descriptions, brackets ([]) indicate optional data or characters. All values are case insensitive.

S, Y, or Z Network Parameters

Header Line 1

The first line of the header has the format

```
Keyword [Parameter] [R[REF][=]value]
```

Keyword indicates the type of network parameter. Its value can be `S[PARAMETERS]`, `Y[PARAMETERS]`, or `Z[PARAMETERS]`. Parameter indicates the form of the data. Its value can be `MA`, `DB`, or `RI`. The default for S-parameters is `MA`. The default for Y- and Z-parameters is `RI`. `R[REF][=]value` is the reference impedance. The default reference impedance is 50 ohms.

The following table explains the meaning of the allowable **Parameter** values.

Parameter	Description
MA	Data is given in (magnitude, angle) pairs with angle in degrees (default for S-parameters).
DB	Data is given in (dB-magnitude, angle) pairs with angle in degrees.
RI	Data is given in (real, imaginary) pairs (default for Y- and Z-parameters).

This example of a first line indicates that the section contains S-parameter data given in (real, imaginary) pairs, and that the reference impedance is 50 ohms.

```
S RI R 50
```

Header Line 2

The second line of the header has the format

```
Independent_variable Units
```

The data in a section is a function of the **Independent_variable**. Currently, for S-, Y-, and Z-parameters, the value of **Independent_variable** is always **F[REQ]**. **Units** indicates the default units of the frequency data. It can be **GHZ**, **MHZ**, or **KHZ**. You must specify **Units**, but you can override this default on any given line of data.

This example of a second line indicates that the default units for frequency data is GHz.

```
FREQ GHZ
```

Data

The data that follows the header typically consists of nine columns.

The first column contains the frequency points where network parameters are measured. They can appear in any order. If the frequency is given in units other than those you specified as the default, you must follow the value with the appropriate units; there should be no intervening spaces. For example,

```
FREQ GHZ
1000MHZ ...
```



```
2000MHZ ...
3000MHZ ...
```

Columns two through nine contain 2-port network parameters in the order N11, N21, N12, N22. Similar to the Touchstone format, each Nnn corresponds to two consecutive columns of data in the chosen form: MA, DB, or RI. The data can be in any valid MATLAB format.

This example is derived from the file `default.amp`. A comment line explains the column arrangement of the data where `re` indicates real and `im` indicates imaginary.

```
S RI R 50
FREQ GHZ
* FREQ      reS11      imS11      reS21      imS21      reS12      imS12      reS22      imS22
  1.00 -0.724725 -0.481324 -0.685727  1.782660  0.000000  0.000000 -0.074122 -0.321568
  1.01 -0.731774 -0.471453 -0.655990  1.798041  0.001399  0.000463 -0.076091 -0.319025
  1.02 -0.738760 -0.461585 -0.626185  1.813092  0.002733  0.000887 -0.077999 -0.316488
```

Noise Parameters

Header Line 1

The first line of the header has the format

Keyword

Keyword must be `NOI[SE]`.

Header Line 2

The second line of the header has the format

Variable Units

Variable must be `F[REQ]`. Units indicates the default units of the frequency data. It can be `GHZ`, `MHZ`, or `KHZ`. You can override this default on any given line of data. This example of a second line indicates that frequency data is assumed to be in `GHZ`, unless other units are specified.

FREQ GHZ

Data

The data that follows the header must consist of five columns.

The first column contains the frequency points at which noise parameters were measured. The frequency points can appear in any order. If the frequency is given in units other than those you specified as the default, you must follow the value with the appropriate units; there should be no intervening spaces. For example,

```
NOI
FREQ GHZ
1000MHZ ...
2000MHZ ...
3      ...
4      ...
5      ...
```

Columns two through five contain, in order,

- Minimum noise figure in decibels
- Magnitude of the source reflection coefficient to realize minimum noise figure
- Phase in degrees of the source reflection coefficient
- Effective noise resistance normalized to the reference impedance of the network parameters

This example is taken from the file `default.amp`. A comment line explains the column arrangement of the data.

```
NOI RN
FREQ GHZ
* Freq Fmin(dB) GammaOpt(MA:Mag) GammaOpt(MA:Ang) RN/Zo
  1.90  10.200000  1.234000      -78.400000      0.240000
  1.93  12.300000  1.235000      -68.600000      0.340000
  2.06  13.100000  1.254000      -56.700000      0.440000
  2.08  13.500000  1.534000      -52.800000      0.540000
  2.10  13.900000  1.263000      -44.400000      0.640000
```

Noise Figure Data

The AMP file format supports the use of frequency-dependent noise figure (NF) data.

Header Line 1

The first line of the header has the format

```
Keyword [Units]
```

For noise figure data, **Keyword** must be **NF**. The optional **Units** field indicates the default units of the NF data. Its value must be **dB**, i.e., data must be given in decibels.

This example of a first line indicates that the section contains NF data, which is assumed to be in decibels.

```
NF
```

Header Line 2

The second line of the header has the format

```
Variable Units
```

Variable must be **F[REQ]**. **Units** indicates the default units of the frequency data. It can be **GHZ**, **MHZ**, or **KHZ**. This example of a second line indicates that frequency data is assumed to be in **GHZ**.

```
FREQ GHZ
```

Data

The data that follows the header typically consists of two columns.

The first column contains the frequency points at which the NF data are measured. Frequency points can appear in any order. For example,

```
NF
FREQ MHz
2090 ...
2180 ...
2270 ...
```

Column two contains the corresponding NF data in decibels.

This example is derived from the file `samplepa1.amp`.

```
NF dB
FREQ GHz
1.900 10.3963213
2.000 12.8797965
2.100 14.0611765
2.200 13.2556751
2.300 12.9498642
2.400 13.3244309
2.500 12.7545104
```

Note: If your noise figure data consists of a single scalar value with no associated frequency, that same value is used for all frequencies. Enter the value in column 1 of the line following header line 2. You must include the second line of the header, but it is ignored.

Power Data

An AMP file describes power data as input power-dependent output power.

Header Line 1

The first line of the header has the format

Keyword [Units]

For power data, **Keyword** must be POUT, indicating that this section contains power data. Because output power is complex, **Units** indicates the default units of the magnitude of the output power data. It can be dBW, dBm, mW, or W. The default is W. You can override this default on any given line of data.

The following table explains the meaning of the allowable **Units** values.

Allowable Power Data Units

Units	Description
dBW	Decibels referenced to one watt
dBm	Decibels referenced to one milliwatt
mW	Milliwatts
W	Watts

This example of a first line indicates that the section contains output power data whose magnitude is assumed to be in decibels referenced to one milliwatt, unless other units are specified.

POUT dBm

Header Line 2

The second line of the header has the format

Keyword [Units] FREQ[=]value

Keyword must be PIN. Units indicates the default units of the input power data. See for a complete list of valid values. The default is W. You can override this default on any given line of data. `FREQ[=]value` is the frequency point at which the power is measured. The units of the frequency point must be specified explicitly using the abbreviations GHz, MHz, kHz, or Hz.

This example of a second line indicates that the section contains input power data that is assumed to be in decibels referenced to one milliwatt, unless other units are specified. It also indicates that the power data was measured at a frequency of 2.1E+009 Hz.

```
PIN dBm FREQ=2.1E+009Hz
```

Data

The data that follows the header typically consists of three columns:

- The first column contains input power data. The data can appear in any order.
- The second column contains the corresponding output power magnitude.
- The third column contains the output phase shift in degrees.

Note: RF Toolbox software does not use the phase data directly. SimRF™ blocks use this data in conjunction with RF Toolbox software to create the AM/PM conversion table for the Equivalent Baseband library **General Amplifier** and **General Mixer** blocks.

If all phases are zero, you can omit the third column. If all phases are zero or omitted, the toolbox assumes that the small signal phase from the network parameter section of the file ($180 \cdot \text{angle}(S_{21}(f)) / \pi$) is the phase for all power levels.

In contrast, if one or more phases in the power data section are nonzero, the toolbox interpolates and extrapolates the data to determine the phase at all power levels. The small signal phase ($180 \cdot \text{angle}(S_{21}(f)) / \pi$) from the network parameter section is ignored.

Inconsistency between the power data and network parameter sections of the file may cause incorrect results. To avoid this outcome, verify that the following criteria must be met:

- The lowest input power value for which power data exists falls in the small signal (linear) region.

- In the power table for each frequency point f , the power gain and phase at the lowest input power value are equal to $20 \cdot \log_{10}(\text{abs}(S_{21}(f)))$ and $180 \cdot \text{angle}(S_{21}(f)) / \pi$, respectively, in the network parameter section.

If the power is given in units other than those you specified as the default, you must follow the value with the appropriate units. There should be no intervening spaces.

This example is derived from the file `default.amp`. A comment line explains the column arrangement of the data.

```
POUT dbm
PIN dBm  FREQ = 2.10GHz
* Pin      Pout      Phase(degrees)
  0.0      19.28      0.0
  1.0      20.27      0.0
  2.0      21.26      0.0
```

Note: The file can contain more than one section of power data, with each section corresponding to a different frequency value. When you analyze data from a file with multiple power data sections, power data is taken from the frequency point that is closest to the analysis frequency.

IP3 Data

An AMP file can include frequency-dependent, third-order input (IIP3) or output (OIP3) intercept points.

Header Line 1

The first line of the header has the format

```
Keyword [Units]
```

For IP3 data, `Keyword` can be either `IIP3` or `OIP3`, indicating that this section contains input IP3 data or output IP3 data. `Units` indicates the default units of the IP3 data. Valid values are `dBW`, `dBm`, `mW`, and `W`. The default is `W`. See for an explanation of the allowable `Units` values.

This example of a first line indicates that the section contains input IP3 data which is assumed to be in decibels referenced to one milliwatt.

```
IIP3 dBm
```

Header Line 2

The second line of the header has the format

```
Variable Units
```

`Variable` must be `FREQ`. `Units` indicates the default units of the frequency data. Valid values are `GHZ`, `MHZ`, and `KHZ`. This example of a second line indicates that frequency data is assumed to be in `GHZ`.

```
FREQ GHZ
```

Data

The data that follows the header typically consists of two columns.

The first column contains the frequency points at which the IP3 parameters are measured. Frequency points can appear in any order.

```
OIP3  
FREQ GHZ  
2.010 ...  
2.020 ...  
2.030 ...
```

Column two contains the corresponding IP3 data.

This example is derived from the file `samplepa1.amp`.

```
OIP3 dBm  
FREQ GHZ  
2.100 38.8730377
```

Note: If your IP3 data consists of a single scalar value with no associated frequency, then that same value is used for all frequencies. Enter the value in column 1 of the line following header line 2. You must include the second line of the header, but the application ignores it.

Inconsistent Data Sections

If an AMP file contains both network parameter data and power data, RF Toolbox software checks the data for consistency.

The toolbox compares the small-signal amplifier gain defined by the network parameters, S_{21} , and by the power data, $P_{out} - P_{in}$. The discrepancy between the two is computed in dBm using the following equation:

$$\Delta P = S_{21}(f_P) - P_{out}(f_P) + P_{in}(f_P)$$

where f_P is the lowest frequency for which power data is specified.

The discrepancy is shown in the following graph.

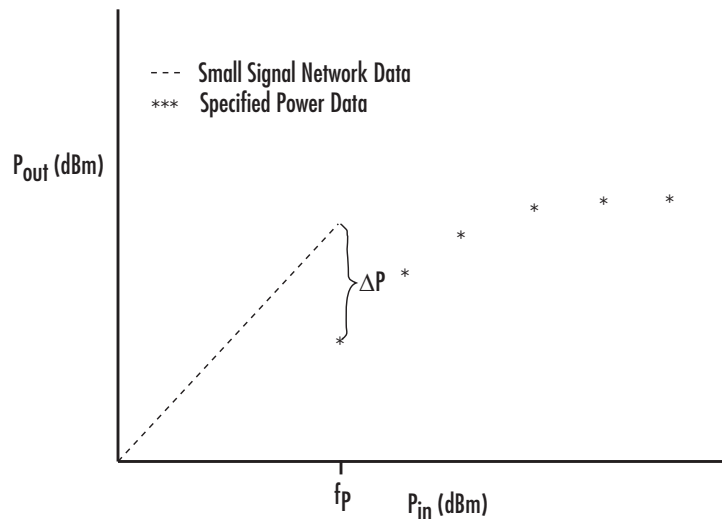

If ΔP is more than 0.4 dB, a warning appears. Large discrepancies may indicate measurement errors that require resolution.